

# marantz®

**Model NA-11S1 Owner's Manual**

---

Network Audio Player

## SAFETY PRECAUTIONS



**CAUTION**  
**RISK OF ELECTRIC SHOCK**  
**DO NOT OPEN**



**CAUTION:**  
**TO REDUCE THE RISK OF ELECTRIC SHOCK, DO NOT REMOVE COVER (OR BACK). NO USER-SERVICEABLE PARTS INSIDE. REFER SERVICING TO QUALIFIED SERVICE PERSONNEL.**

The lightning flash with arrowhead symbol, within an equilateral triangle, is intended to alert the user to the presence of uninsulated "dangerous voltage" within the product's enclosure that may be of sufficient magnitude to constitute a risk of electric shock to persons.

The exclamation point within an equilateral triangle is intended to alert the user to the presence of important operating and maintenance (servicing) instructions in the literature accompanying the appliance.

**WARNING:**  
**TO REDUCE THE RISK OF FIRE OR ELECTRIC SHOCK, DO NOT EXPOSE THIS APPLIANCE TO RAIN OR MOISTURE.**

## IMPORTANT SAFETY INSTRUCTIONS

1. Read these instructions.
2. Keep these instructions.
3. Heed all warnings.
4. Follow all instructions.
5. Do not use this apparatus near water.
6. Clean only with dry cloth.
7. Do not block any ventilation openings. Install in accordance with the manufacturer's instructions.
8. Do not install near any heat sources such as radiators, heat registers, stoves, or other apparatus (including amplifiers) that produce heat.
9. Protect the power cord from being walked on or pinched particularly at plugs, convenience receptacles, and the point where they exit from the apparatus.
10. Only use attachments/accessories specified by the manufacturer.
11. Use only with the cart, stand, tripod, bracket, or table specified by the manufacturer, or sold with the apparatus. When a cart is used, use caution when moving the cart/apparatus combination to avoid injury from tip-over.
12. Unplug this apparatus during lightning storms or when unused for long periods of time.
13. Refer all servicing to qualified service personnel. Servicing is required when the apparatus has been damaged in any way, such as power-supply cord or plug is damaged, liquid has been spilled or objects have fallen into the apparatus, the apparatus has been exposed to rain or moisture, does not operate normally, or has been dropped.
14. Batteries shall not be exposed to excessive heat such as sunshine, fire or the like.



### CAUTION:

To completely disconnect this product from the mains, disconnect the plug from the wall socket outlet. The mains plug is used to completely interrupt the power supply to the unit and must be within easy access by the user.

### DECLARATION OF CONFORMITY

We declare under our sole responsibility that this product, to which this declaration relates, is in conformity with the following standards: EN60065, EN55013, EN55020, EN61000-3-2, EN61000-3-3, EN300328, EN301489-01, EN301489-17 and EN50371. Following the provisions of Low Voltage Directive 2006/95/EC and EMC Directive 2004/108/EC, the EC regulation 1275/2008 and its frame work Directive 2009/125/EC for Energy-related Products (ErP).

Marantz Europe  
A division of D&M Europe B.V.  
Beemdstraat 11, 5653 MA Eindhoven,  
The Netherlands

### A NOTE ABOUT RECYCLING:

This product's packaging materials are recyclable and can be reused. Please dispose of any materials in accordance with the local recycling regulations.

When discarding the unit, comply with local rules or regulations.

Batteries should never be thrown away or incinerated but disposed of in accordance with the local regulations concerning battery disposal.

This product and the supplied accessories, excluding the batteries, constitute the applicable product according to the WEEE directive.



Pb

## ☐ NOTES ON USE

### WARNINGS

- Avoid high temperatures.  
Allow for sufficient heat dispersion when installed in a rack.
- Handle the power cord carefully.  
Hold the plug when unplugging the cord.
- Keep the unit free from moisture, water, and dust.
- Unplug the power cord when not using the unit for long periods of time.
- Do not obstruct the ventilation holes.
- Do not let foreign objects into the unit.
- Do not let insecticides, benzene, and thinner come in contact with the unit.
- Never disassemble or modify the unit in any way.
- Ventilation should not be impeded by covering the ventilation openings with items, such as newspapers, tablecloths or curtains.
- Naked flame sources such as lighted candles should not be placed on the unit.
- Observe and follow local regulations regarding battery disposal.
- Do not expose the unit to dripping or splashing fluids.
- Do not place objects filled with liquids, such as vases, on the unit.
- Do not handle the mains cord with wet hands.
- When the switch is in the OFF (STANDBY) position, the equipment is not completely switched off from MAINS.
- The equipment shall be installed near the power supply so that the power supply is easily accessible.
- Do not keep the battery in a place exposed to direct sunlight or in places with extremely high temperatures, such as near a heater.

## ☐ CAUTIONS ON INSTALLATION

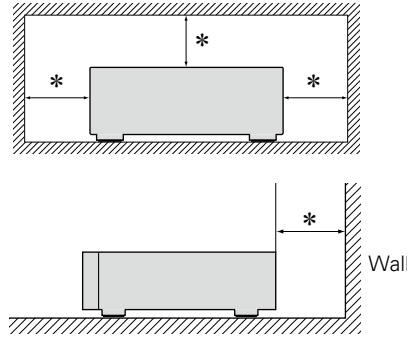

**\* For proper heat dispersal, do not install this unit in a confined space, such as a bookcase or similar enclosure.**

- More than 0.1 m is recommended.

# Getting started

Thank you for purchasing this Marantz product. To ensure proper operation, please read these owner's manual carefully before using the product. After reading this manual, be sure to keep it for future reference.

## Contents

<b>Getting started</b> .....	1
Accessories .....	1
Main features .....	2
Cautions on handling .....	3
About the remote control .....	3

## Preparation .....

<b>Connections</b> .....	6
Analog connections .....	6
Digital connections .....	7
PC connection .....	7
Connecting to a home network (LAN) .....	8
Connecting other equipment .....	9
Remote control jacks connection .....	9
Connecting the power cord .....	10
<b>Setup</b> .....	11
Menu map .....	11
Setting the first setup [Quick Setup] .....	12
General Settings [General] .....	12
Setting the network [Network] .....	15
Setting the audio [Audio] .....	18

## Operation .....

<b>Operation</b> .....	21
Preparation .....	21
Operations possible during playback .....	21
Network audio playback .....	23
Favorite function .....	29
iPod playback .....	30
USB memory device playback .....	32
AirPlay function .....	34
Remote play function .....	36
Web control function .....	37
Using as a D/A converter .....	39
Other functions .....	40

## Information .....

<b>Part names and functions</b> .....	43
Front panel .....	43
Rear panel .....	43
Remote control .....	44
<b>Other information</b> .....	45
iPod .....	45
USB memory device .....	45
Network audio .....	46
<b>Explanation terms</b> .....	48
<b>Troubleshooting</b> .....	50
Resetting the microprocessor .....	54
<b>Specifications</b> .....	54

## Accessories

Check that the following parts are supplied with the product.

① Getting Started .....	1
② CD-ROM (Owner's manual) .....	1
③ Safety Instructions .....	1
④ Power cord .....	1
⑤ Remote control unit (RC002NA) .....	1
⑥ R03/AAA batteries .....	2
⑦ Audio cable .....	1
⑧ Remote connector cable .....	1

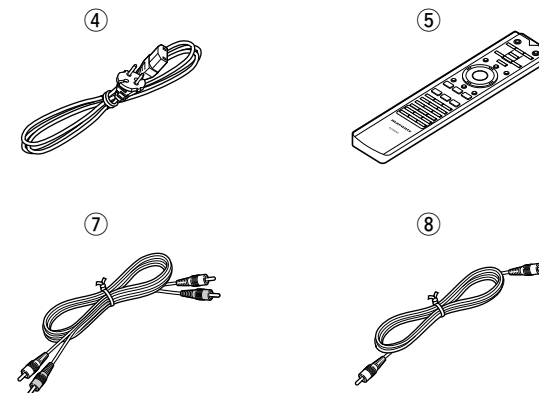

## Main features

### Playback of DSD file

This unit can play the DSD file via USB Type B.

### Toroidal transformer

This unit features a toroidal transformer that produces less vibration and magnetic leakage flux compared to conventional power transformers. The materials and manufacturing process of the ring-shaped core are strictly controlled to reduce vibration, while the short-ring attached to the perimeter of the transformer reduce magnetic leakage flux.

### Large-capacitance block capacitor

A large capacitance 4700  $\mu$ F capacitor carefully selected for its acoustic characteristics is incorporated into the Audio power supply circuit.

### Audiophile-grade film capacitors and electrolytic capacitors

The unit's features the same audiophile-grade film capacitors and electrolytic capacitors specifically used in top-range models.

### Low-noise low-distortion filter circuit and highspeed HDAMSA2-type output amplifier with the differential input type HDAM

### Double-layered chassis

### High-grade machined analog audio output connectors

### Can be used as a D/A convertor

Digital audio signals input from an external device or computer into this unit can be converted and output as analog signals using this unit's D/A converter.

### Inverted-phase analog output signal is possible

The USA system balanced output of this unit can be inverted to permit a balanced input to a European type amplifier.

### Peripheral circuitry off function minimizes audio output signal interference

In order to minimize noise from peripheral circuitry which could interfere with the analog audio signal, this unit is equipped with a peripheral circuitry off function which turns off the digital output circuit, the display, and the illumination lamp.

### Filter switching function

Switching between 2 types of filter characteristics is possible during playback in the DSD file and PCM file, allowing the listener to enjoy different shadings of the music.

### Supports Internet Radio and music streaming Supports AirPlay® (👉 [page 34](#))

### DLNA ver. 1.5 support for audio networks

### Supports online music, including Last.fm, Spotify

### Support for High Quality Audio playback WAV/FLAC/ALAC (Apple Lossless Audio Codec)

### Support for Gapless playback Playback with no gap between music files (for WAV/FLAC only)

### iPod auto detect charges your device even after this unit switches to standby mode

### "Marantz Remote App" compatibility for performing basic unit operations with an iPad®, iPhone or Android smartphone

### OLED (Organic Light Emitting Diode) display that can display 3 lines

### Auto Standby mode for energy savings

## Cautions on handling

### • Before turning the power switch on

Check once again that all connections are correct and that there are no problems with the connection cables.

- Power is supplied to some of the circuitry even when the unit is set to the standby mode. When going on vacation or leaving home for long periods of time, be sure to unplug the power cord from the power outlet.

### • About condensation

If there is a major difference in temperature between the inside of the unit and its surroundings, condensation may form on parts inside the unit, causing it to fail to operate properly.

If this happens, let the unit sit for an hour or two with the power turned off and wait until there is little difference in temperature before using the unit.

### • Cautions on using smartphones

Using a smartphone near this unit may result in noise. If that occurs, move the smartphone away from the unit when it is in use.

### • Moving the unit

Turn off the power and unplug the power cord from the power outlet. Next, disconnect the cables connected to other system units before moving the unit.

## About the remote control

### Inserting the batteries

- ① Remove the rear cover of the remote control.

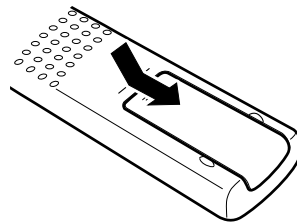

- ② Set two R03/AAA batteries in the battery compartment in the indicated direction.

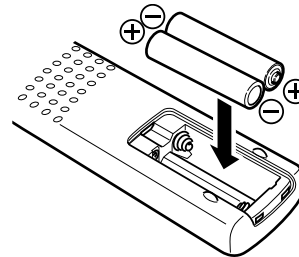

- ③ Put the rear cover back on.

### NOTE

- Insert the specified batteries in the remote control.
- Replace the batteries with new ones if the set does not operate even when the remote control is operated close to the unit. (The supplied batteries are only for verifying operation. Replace them with new batteries at an early date.)
- When inserting the batteries, be sure to do so in the proper direction, following the ⊕ and ⊖ marks in the battery compartment.
- To prevent damage or leakage of battery fluid:
  - Do not use a new battery together with an old one.
  - Do not use two different types of batteries.
  - Do not attempt to charge dry batteries.
  - Do not short-circuit, disassemble, heat or dispose of batteries in flames.
  - Do not keep the battery in a place exposed to direct sunlight or in places with extremely high temperatures, such as near a heater.
- If the battery fluid should leak, carefully wipe the fluid off the inside of the battery compartment and insert new batteries.
- Remove the batteries from the remote control if it will not be in use for long periods.
- Used batteries should be disposed of in accordance with the local regulations regarding battery disposal.
- The remote control may function improperly if rechargeable batteries are used.

## Operating range of the remote control

Point the remote control at the remote sensor when operating it.

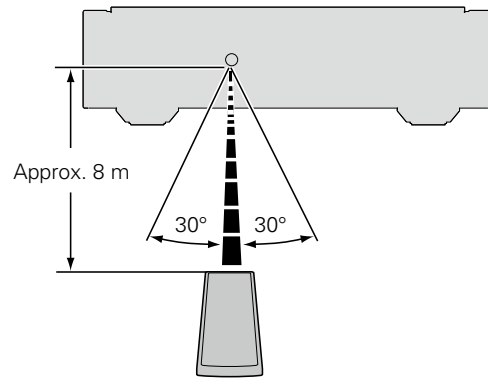

### NOTE

- The set may function improperly or the remote control may not operate if the remote control sensor is exposed to direct sunlight, strong artificial light from an inverter type fluorescent lamp or infrared light.
- When using 3D video devices that transmit radio communication signals (such as infrared signals etc) between the various units (such as the monitor, 3D glasses, 3D transmitter unit etc), the remote control may not operate due to interference from those radio communication signals. If this occurs, adjust the direction and distance of the 3D communication for each unit, and check that the remote control operation is not affected by these signals.

## Marantz Remote App

Marantz Remote App is a unique application developed for the iPhone, iPod touch and Android smartphone. This application enables you to control Marantz network devices that are connected to your home network. Install the App onto your iPhone, iPod touch or Android smartphone to control this device.



- Bidirectional communication is performed.
- The Marantz Remote App can be downloaded for free from the Apple App Store or Google Play store.

# Preparation

---

Here, we explain the connections and basic operation methods for this unit.

- **Connections**  [page 6](#)
- **Setup**  [page 11](#)



# Connections

## NOTE

- Do not plug in the power cord until all connections have been completed.
- When making connections, also refer to the operating instructions of the other components.
- Be sure to connect the left and right channels properly (left with left, right with right).
- Do not bundle power cords together with connection cables. Doing so can result in humming or noise.
- Do not connect the unit to the PHONO input connectors on the amplifier.

## Cables used for connections

Audio cable (supplied)	
Audio cable	
Remote connector cable	
Audio cable (sold separately)	
Balanced audio cable	
Optical cable	
Coaxial digital cable	
iPod cable	
USB cable	
Cable (sold separately)	
LAN cable	
Monaural mini-plug cable	

## Analog connections

### UNBALANCED

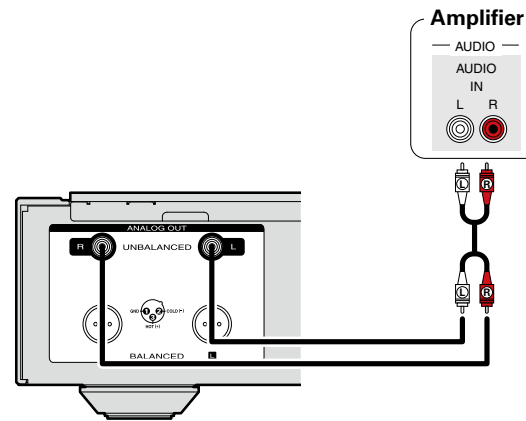

### BALANCED

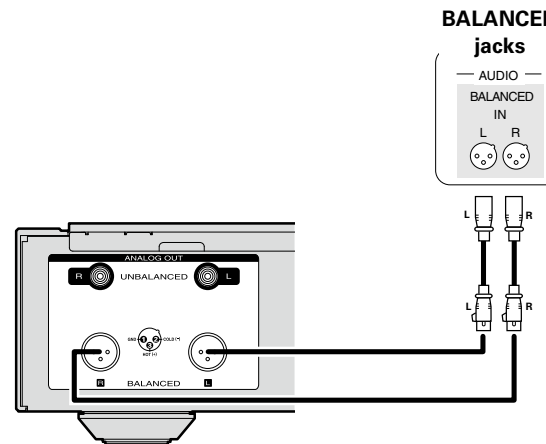

### BALANCED Jacks

The BALANCED jacks on this unit are equipped with XLR connectors that are widely used on professional equipment. Their features are listed below.

- The 3 pin construction enables the musical signal to be transmitted as a balanced signal, with little effect from external noise.
- The detachable locking mechanism minimizes connector play and enhances connection reliability.

The XLR connector for professional use is internally wired in either of the following two systems. This unit employs the USA system.

- USA system (② PIN=COLD ③ PIN=HOT)

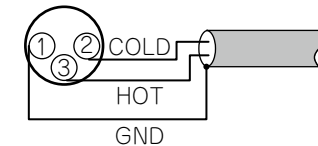

- European system (② PIN=HOT ③ PIN=COLD)

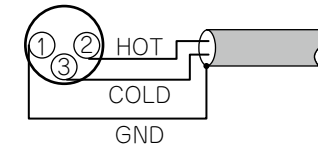

If a product that employs the European system is connected with this unit via a balanced cable, the reproduced signal may be phase-inverted.

To correct the inversion, set the "Phase" to "Inverted" at the menu setting ([page 19](#)).

## Digital connections

When connecting, use a commercially available optical digital cable or coaxial digital cable.

### Digital audio output

Connect digital devices such as AV receivers and D/A converters with the unit to enjoy digital audio output from the unit.

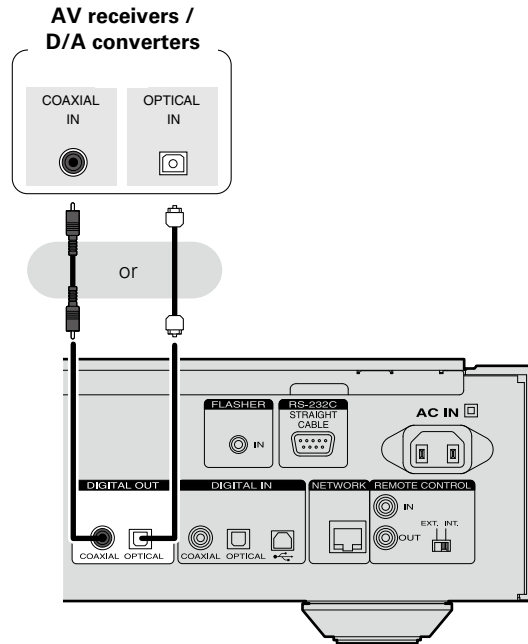

#### NOTE

- Digital audio output is stopped during DSD signal playback.
- The digital audio output can be turned on/off in the "Digital Out" menu (page 18).

- ❑ **When connecting the optical digital output connector with an optical transmission cable (sold separately)**

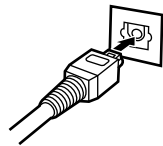

Match the shapes then insert firmly.

### Digital audio input

If a device equipped with CD transport or digital audio output is connected to this unit, this unit can be used as a D/A converter (page 39 "Using as a D/A converter").

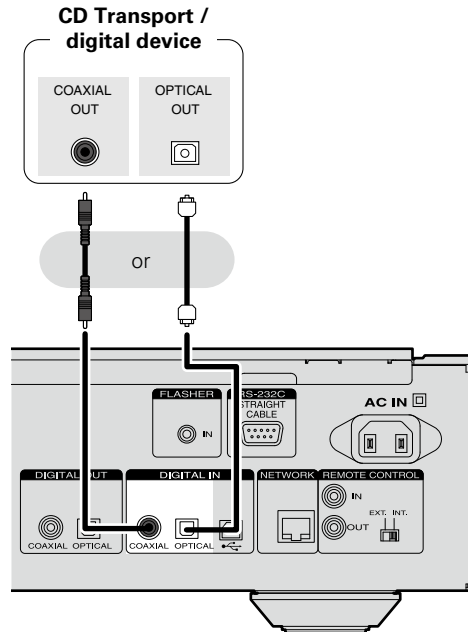

#### NOTE

- Linear PCM signals with a sampling frequency of 32 kHz, 44.1 kHz, 48 kHz, 64 kHz, 88.2 kHz, 96 kHz, 176.4 kHz, or 192 kHz can be input into this device.
- Do not input signals other than linear PCM signals, such as Dolby digital, DTS, AAC etc. into this device. Doing so may cause noise, which may cause damage to the speakers.

## PC connection

By connecting a computer to the USB port on the rear panel of this unit using a commercially available USB cable, this unit can be used as a D/A converter (page 39 "Using as a D/A converter").

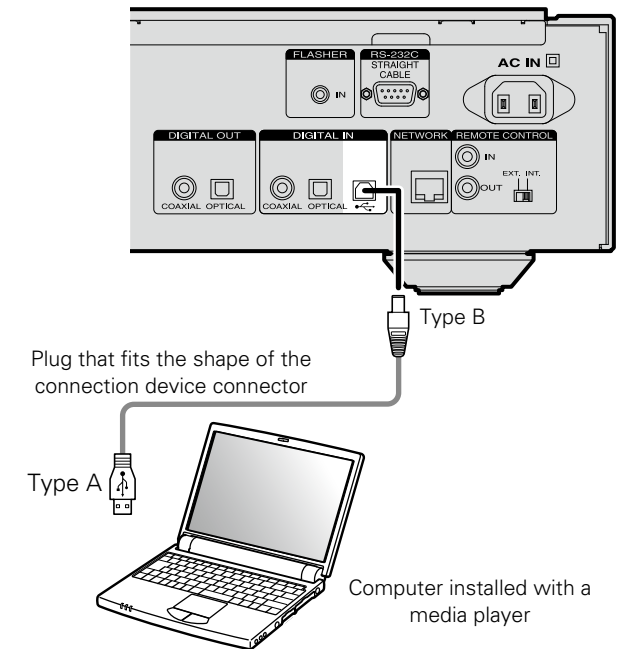

#### NOTE

- Operation will not occur correctly if connected to the computer before the dedicated driver has been installed.
- Use a cable that is 3 m or less to connect to the computer.

## Connecting to a home network (LAN)

- This unit lets you play via your home network (LAN) music files stored on a computer and music content such as that from Internet radio.  
You can also operate this unit from a computer using the Web control function.
- You can update by downloading the latest firmware from the Marantz website.  
For more information, see "Update" (page 12).
- See "Setting the network [Network]" (page 15) for more information on network setting.

## Wired LAN

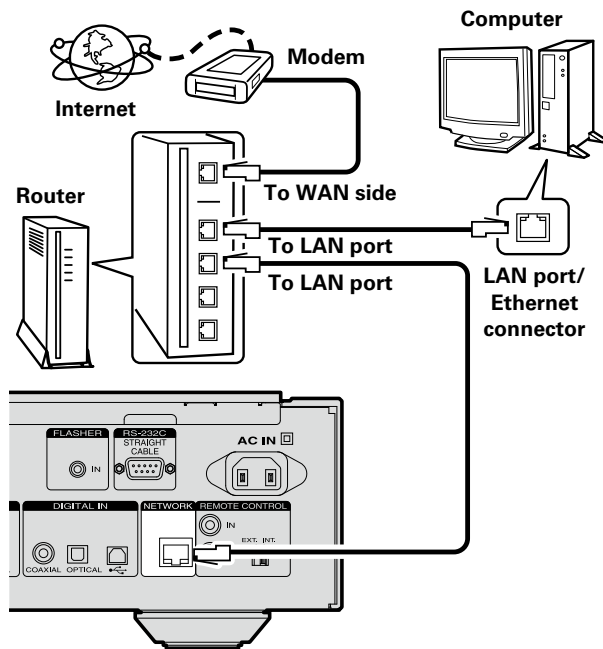

For connections to the Internet, contact an ISP (Internet Service Provider) or a computer shop.

## Required system

### ❑ Broadband Internet connection

### ❑ Modem

A device that connects to the broadband circuit and conducts communications on the Internet.  
A type that is integrated with a router is also available.

### ❑ Router

When using this unit, we recommend you use a router equipped with the following functions:

- Built-in DHCP server  
This function automatically assigns IP addresses on the LAN.
- Built-in 100BASE-TX switch  
When connecting multiple devices, we recommend a switching hub with a speed of 100 Mbps or greater.

### ❑ LAN cable (CAT-5 or greater recommended)

- Use only a shielded STP or ScTP LAN cable which is available at retailer.
- Some flat type LAN cables are easily affected by noise.  
We recommend using a normal type cable.



- If you have an Internet provider contract for a line on which network settings are made manually, make the settings at "Network connecting (when "DHCP" settings is "Off")" (page 15).
- With this unit, it is possible to use the DHCP and Auto IP functions to make the network settings automatically.
- When using this unit with the broadband router's DHCP function enabled, this unit automatically performs the IP address setting and other settings.  
When using this unit connected to a network with no DHCP function, make the settings for the IP address, etc., at "Network connecting (when "DHCP" settings is "Off")" (page 15).
- When setting manually, check the setting contents with the network administrator.

### NOTE

- A contract with an ISP is required to connect to the Internet.
- No additional contract is needed if you already have a broadband connection to the Internet.
- The types of routers that can be used depend on the ISP. Contact an ISP or a computer shop for details.
- Marantz assumes no responsibility whatsoever for any communication errors or troubles resulting from customer's network environment or connected devices.
- This unit is not compatible with PPPoE. A PPPoE-compatible router is required if you have a contract for a type of line set by PPPoE.
- Do not connect an Ethernet connector directly to the LAN port/ Ethernet connector on your computer.
- To listen to audio streaming, use a router that supports audio streaming.

## Connecting other equipment

### RS-232C

Connect an external control device or other device for servicing. (Use a straight cable for the connection.)

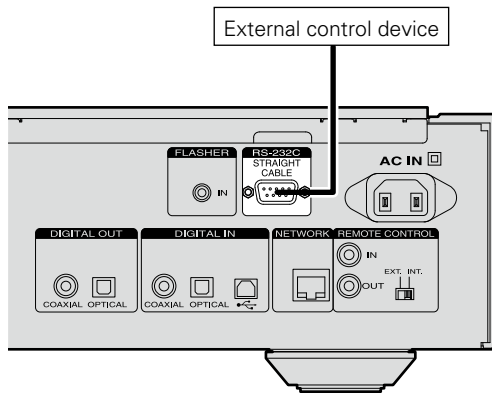

### FLASHER IN

This unit can be controlled by connecting a control box or other control device to this unit.

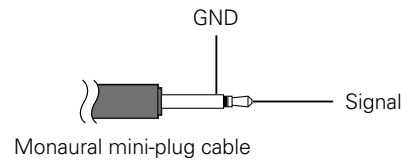
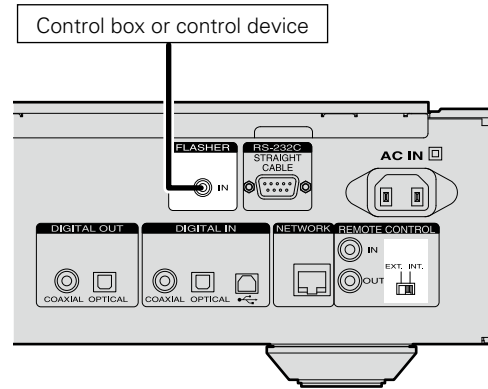

To use the FLASHER IN jack, set the remote control switch to "INT.".

## Remote control jacks connection

If this unit is connected to a Marantz amp, the amp can be controlled via this unit using the Marantz Remote App or web control function (see page 37). Also, remote control signals received by the amp can be used to control this unit.

### Connection

Use the supplied remote connection cable to connect the REMOTE CONTROL IN terminal of this unit to REMOTE CONTROL OUT terminal of the amplifier.

### Setting

Set the remote control switch on the rear panel of this unit to "EXT." to use this feature.

- This setting will disable remote sensor reception of this unit.
- To operate the unit, point the remote control at the remote sensor of the amplifier.

To use this unit without connecting it to the amplifier, set the remote control switch to "INT.".

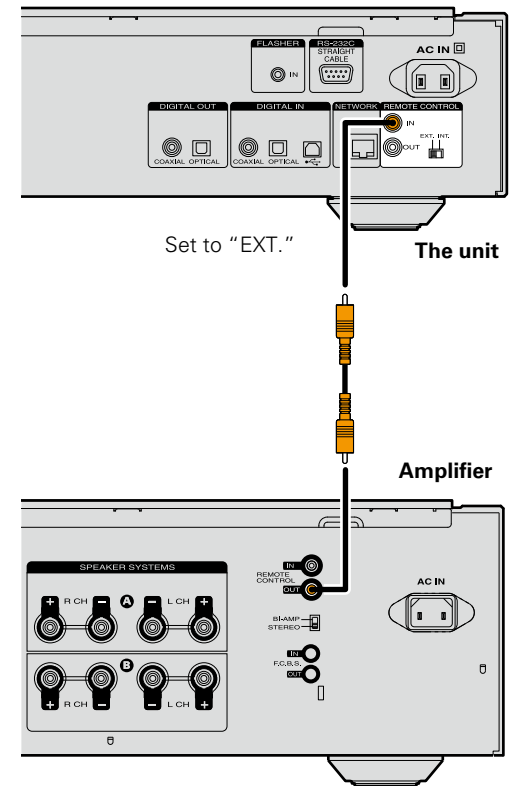

## Connecting the power cord

When all of the connections are completed, insert the power plug into the power outlet.

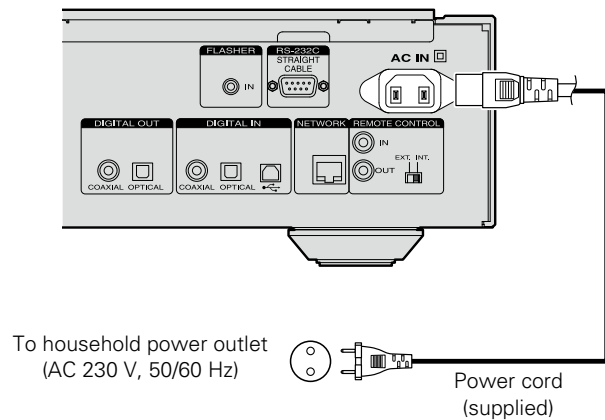

### NOTE

- Insert the plugs securely. Loose connections will result in the generation of noise.
- Do not unplug the power cord while the unit is operating.
- Do not use a power cord other than the cord supplied with this unit.

# Setup

## Menu map

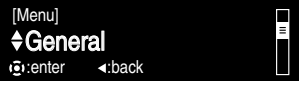
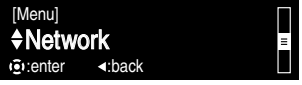
Setting items	Detailed items	Description	Page	
<b>Quick Setup</b> 	<b>Quick Setup</b>	Performs the network settings using a Wizard style window. For details on the operations, see the separate "Getting Started".	-	
<b>General</b> 	<b>Language</b>	Sets the language.	<a href="#">12</a>	
	<b>Auto-Standby</b>	Sets the unit power to standby when the unit is not in use.	<a href="#">12</a>	
	<b>Firmware</b>	<b>Update Notification</b> Updates the firmware. <a href="#">12</a> <b>Add New Feature</b> Set the Update and Upgrade notification on/off. <a href="#">13</a> Displays new functions that can be downloaded, and upgrades functions. <a href="#">14</a>		
<b>Network</b> 	<b>Network Information</b>	Displays various information about the network.	-	
	<b>Network Control</b>	Performs the On/Off settings for the network function when in standby mode.	<a href="#">17</a>	
	<b>Friendly Name</b>	Edits a name displayed on the Internet.	<a href="#">17</a>	
	<b>Last.fm Display</b>	Disables the display of Last.fm on the menu.	<a href="#">17</a>	
	<b>Settings</b>	<b>DHCP (On) or DHCP (Off)</b>	Performs the DHCP setting.	<a href="#">15</a>
		<b>IP Address*</b>	Performs the IP address setting.	<a href="#">15</a>
		<b>Subnet Mask*</b>	Performs the subnet mask setting.	<a href="#">15</a>
		<b>Gateway*</b>	Performs the gateway setting.	<a href="#">15</a>
		<b>Primary DNS*</b>	Performs the primary DNS setting.	<a href="#">15</a>
		<b>Secondary DNS*</b>	Performs the secondary DNS setting.	<a href="#">15</a>
		<b>Proxy</b>	Performs the proxy setting.	<a href="#">16</a>
<b>Test Connection</b>	Performs the wired LAN connection.	<a href="#">15</a>		
<b>Audio</b>	<b>Noise Shaper</b>	Performs the noise shaper setting.	<a href="#">18</a>	
	<b>DC Filter</b>	Performs the DC filter setting.	<a href="#">18</a>	
	<b>Digital Out</b>	Performs the digital out setting.	<a href="#">18</a>	
	<b>Phase</b>	Performs the phase setting.	<a href="#">19</a>	

\* Displayed when the "DHCP" setting is "Off" ([page 15](#)).

## Menu operation

**1 Press MENU.**  
Turns on the Menu settings mode and the Menu appears on the display ([page 11](#) "Menu map").

**2 Use  $\Delta$ / $\nabla$  and ENTER to select menu you want to change.**

• To back to the top of the menu, during menu operation, press **HOME**.

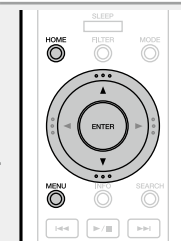

## Setting the first setup [Quick Setup]

- For details on “Quick Setup” operations, see the separate “Getting Started”.
- If you cancelled “Quick Setup” menu or changed the network environment, perform “Menu” – “Quick Setup”.

## General Settings [General]

### Language

- Sets the language for display the menu.
- The default setting is “English”.

**1 Press MENU.**  
Turns on the Menu settings mode and the Menu appears on the display (refer page 11 “Menu map”).

**2 Use  $\Delta$ / $\nabla$  and ENTER to select “General” – “Language”, then press ENTER or  $\triangleright$ .**



English / Deutsch / Français / Italiano /  
Nederlands / Español / Svenska

### Auto-Standby

When this unit is in the stop state and there is no input signal and operation for 15 minutes, it automatically enters the standby mode.

- The default setting is “On”.

**1 Press MENU.**  
Turns on the Menu settings mode and the Menu appears on the display (refer page 11 “Menu map”).

**2 Use  $\Delta$ / $\nabla$  and ENTER to select “General” – “Auto-Standby”, then press ENTER or  $\triangleright$ .**  
“Select Auto-Standby” menu appears.

**3 Use  $\Delta$ / $\nabla$  to select “On” or “Off”, then press ENTER or  $\triangleright$ .**  
The setting is entered.



#### NOTE

In the following situations, the Auto-Standby function does not operate.

- When the source is “iPod” (Direct mode) or “AirPlay”.

### Firmware

#### Update

- In order to update the firmware, the environment and settings required for connecting to broadband internet are needed (refer page 8).
- Perform the firmware update operation after at least 2 minutes has elapsed since turning this unit’s power ON.

**1 Press MENU.**  
Turns on the Menu settings mode and the Menu appears on the display (refer page 11 “Menu map”).

**2 Use  $\Delta$ / $\nabla$  and ENTER to select “General” – “Firmware” – “Update”, then press ENTER or  $\triangleright$ .**

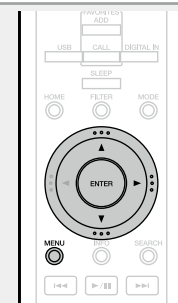

**Check For Update** Check for firmware updates. You can also check approximately how long it will take to complete an update.

**Update Start** Execute the update process.

- If updating fails, the set automatically retries, but if updating is still not possible, one of the messages shown below is displayed. If the display reads as shown below, check the settings and network environment, then update again.

Display	Description
<b>Updating fail</b>	Updating failed.
<b>Login failed</b>	Failure to login to server.
<b>Server is busy</b>	Server is busy. Wait a while then try again.
<b>Connection fail</b>	Failure in connecting to server.
<b>Download fail</b>	Downloading of the firmware has failed.

**Update on web screen**

Firmware can be updated using the “Web control function” (page 37). “Web control function” (page 37) settings must be completed in advance on a PC belonging to the same network. For information on obtaining update files, please contact our customer service center.

**1 Click ④ from step 5 for the “Web control function” (page 37).**

The PC will display the following screen. Wait for approximately 1 minute. You can also gain access by entering the IP address shown by the unit into a web browser.

[The web display]

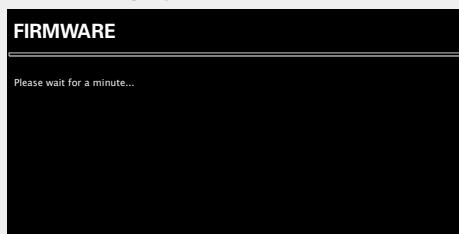

[The unit's screen display]



**2 When the following screen is displayed by the PC, click the “Choose File” (①) button, select the update file, and click the “Upload” (②) button.**

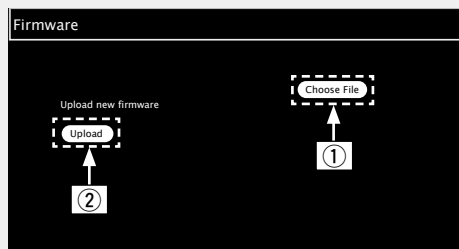

**3 When the following screen is displayed, click the “OK” (③) button. Updating will begin.**

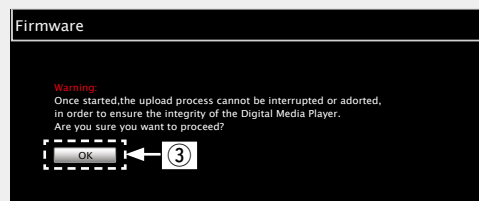

**NOTE**

Do not operate the unit while updating is in progress.

**4 When the following screen is displayed, updating is complete.**

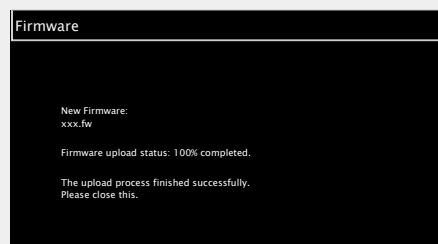

Button names may vary depending on the OS language used on your computer.

**Notification**

**Update**

Displays a notification message on this unit's menu screen when the latest firmware is released with “Update”. Connect to broadband Internet (page 8) when using this function.

**1 Press MENU.**

Turns on the Menu settings mode and the Menu appears on the display (page 11 “Menu map”).

**2 Use  $\Delta$ / $\nabla$  and ENTER to select “General” – “Firmware” – “Notification” – “Update”, then press ENTER or  $\triangleright$ .**

“Update Notification” menu appears.

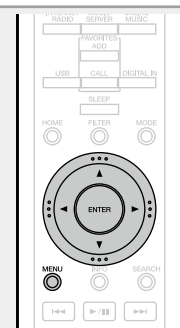

**3 Use  $\Delta$ / $\nabla$  to select “On”, then press ENTER or  $\triangleright$ .**

**On** Display update message.

**Off** Do not display update message.



- When you press **ENTER** during display of the notification message, the “Check For Update” is displayed. (Refer to page 12 for more information on “Update”.)
- Press  $\triangleleft$  to erase the notification message.



## Upgrade

Display a notification message on this unit's menu screen when downloadable firmware is released with "Add New Feature".

Connect to broadband Internet ([page 8](#)) when using this function.

### 1 Press MENU.

Turns on the Menu settings mode and the Menu appears on the display ([page 11](#) "Menu map").

### 2 Use $\Delta$ / $\nabla$ and ENTER to select "General" – "Firmware" – "Notification" – "Upgrade", then press ENTER or $\triangleright$ .

"Upgrade Notification" menu appears.

### 3 Use $\Delta$ / $\nabla$ to select "On", then press ENTER or $\triangleright$ .

**On** Display upgrade message.

**Off** Do not display upgrade message.

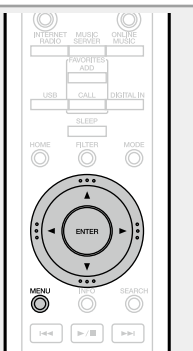

## □ Add New Feature

- In order to add new functions, the environment and settings required for connecting to broadband internet are needed ([page 8](#)).
- Perform the add new feature operation after at least 2 minutes has elapsed since turning this unit's power on.

### 1 Press MENU.

Turns on the Menu settings mode and the Menu appears on the display ([page 11](#) "Menu map").

### 2 Use $\Delta$ / $\nabla$ to select "General" – "Firmware" – "Add New Feature", then press ENTER or $\triangleright$ .

**Upgrade Status** Display a list of the additional functions provided by the upgrade.

**Upgrade Start** Execute the upgrade process.

- If the upgrade is not successful, an error message identical to those in "Update" ([page 12](#)) will appear on the display. Check the settings and network environment, then update again.

**Upgrade ID** The ID number shown on this screen is needed when carrying out the procedure.

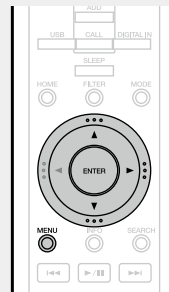

## [Notes concerning use of "Update" and "Add New Feature"]

- Do not turn off the power until updating or upgrading is completed.
- Even with a broadband connection to the Internet, approximately 20 minutes is required for the updating/upgrading procedure to be completed.
- Once updating/upgrade starts, normal operations on this unit cannot be performed until updating/upgrading is completed.
- Furthermore, updating/upgrading the firmware may reset the backup data for the parameters, etc. set for this unit.
- If the update or upgrade fails, remove and re-insert the power cord. "Update Retry" appears on the display and update restarts from the point at which update failed. If the error continues despite this, check the network environment.



- Information regarding the "Update" function and "Add New Feature" will be announced on the Marantz web site each time related plans are defined.
- When usable new firmware is released with "Update" or "Add New Feature", a notification message is displayed on the menu screen. When you do not want to be notified, set "Update" ([page 13](#)) and "Upgrade" ([page 14](#)) to "Off".



- When you press **ENTER** during display of the notification message, the "Add New Feature" is displayed. (Refer to [page 14](#) for more information on "Add New Feature".)
- Press  $\triangleleft$  to erase the notification message.



See the Marantz website for details about updates. When the procedure is complete, "Registered" is displayed and updates can be carried out. If the procedure has not been carried out, "Not Registered" is displayed.

## Setting the network [Network]

- For details on “Quick Setup” operations, see the separate “Getting Started”.
- If you cancelled “Quick Setup” menu or changed the network environment, perform “Menu” – “Quick Setup”.

### Connecting wired LAN

Use this procedure to configure the wired LAN settings.

#### Network connecting

(when “DHCP” settings are “On”)

When using this unit with the broadband router’s DHCP function enabled, this unit automatically performs the IP address setting and other settings.

**1** Connect the LAN cable ([page 8](#) “Connecting to a home network (LAN)” – “Wired LAN”).

**2** Press  (on/standby) to turn on power to the main unit.

**3** Press **MENU**. Turns on the Menu settings mode and the Menu appears on the display ([page 11](#) “Menu map”).

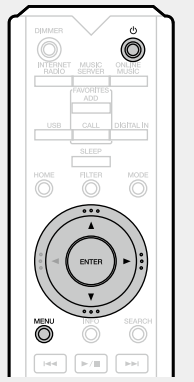

**4** Use  $\Delta$ / $\nabla$  and **ENTER** to select “Network” – “Settings” – “DHCP (On)”, then press **ENTER** or  $\triangleright$ . “Select DHCP” menu appears.

**5** Use  $\Delta$ / $\nabla$  to select “On”, then press **ENTER** or  $\triangleright$ . “Setup Ethernet” menu appears.

**6** Use  $\Delta$ / $\nabla$  to select “Test Connection”, then press **ENTER** or  $\triangleright$ . “Wait for the network to connect...” is displayed, and the unit starts connecting to the LAN.

- When the connection is made successfully, “Connected!” appears.
- If the connection cannot be established, “Connection Failed” is displayed. Perform steps 1 – 6 again.



You may need to set the network connection manually, depending on the provider you use. To set the connection manually, use the setting procedure of “Network connecting (when “DHCP” settings are “Off”)”.

#### Network connecting (when “DHCP” settings is “Off”)

This section explains the settings when connecting this unit to a network that does not have a DHCP function.



To configure the settings manually, check the setting details with your network administrator.

**1** Perform steps 1 – 4 of the “Network connecting (when “DHCP” settings are “On”)” procedure and select “Off” in step 5. “Setup Ethernet” menu appears.

**2** Use  $\Delta$ / $\nabla$  to select “IP Address”, then press **ENTER** or  $\triangleright$ . “Enter IP Address” menu appears.

**3** Use  $\Delta$ / $\nabla$ / $\triangleright$  or 0 – 9 to input the IP address and press **ENTER**.

**4** Use  $\Delta$ / $\nabla$ / $\triangleright$  or 0 – 9 to input the address for “Subnet Mask”, “Gateway”, “Primary DNS”, and “Secondary DNS”.

**5** Use  $\Delta$ / $\nabla$  to select “Test Connection”, then press **ENTER** or  $\triangleright$ . “Wait for the network to connect...” is displayed, and the unit starts connecting to the LAN.

- When the connection is made successfully, “Connected!” appears.
- If the connection cannot be established, “Connection Failed” is displayed. Perform steps 1 – 5 again.

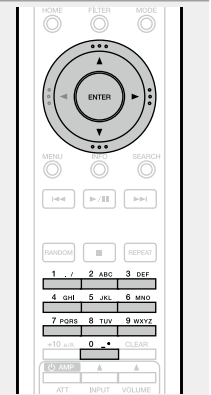

**Proxy settings**

Configure these settings to connect to the internet via a proxy server.

**1 Press MENU.**

Turns on the Menu settings mode and the Menu appears on the display (see [page 11](#) "Menu map").

**2 Use  $\Delta$ / $\nabla$  and ENTER to select "Network" – "Settings" – "Proxy", then press ENTER or  $\triangleright$ .**

"Setup Proxy" menu appears.

**3 If "Proxy(On)" appears, go to step 5. If "Proxy(Off)" appears, press ENTER or  $\triangleright$ .**

"Select Proxy" menu appears.

**4 Use  $\Delta$ / $\nabla$  to select "On", then press ENTER or  $\triangleright$ .**

"Setup Proxy" menu appears.

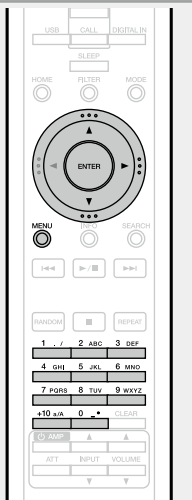
**5 Use  $\Delta$ / $\nabla$  to select "Proxy (Address)" or "Proxy (Name)", then press ENTER or  $\triangleright$ .**

"Select Type" menu appears.

**6 Use  $\Delta$ / $\nabla$  to select "Address" or "Name", then press ENTER or  $\triangleright$ .**

"Setup Proxy" menu appears.

**7 Use  $\Delta$ / $\nabla$  to select "Address" or "Name", then press ENTER or  $\triangleright$ .**

"Enter Proxy Address" or "Enter Proxy Name" menu appears.

**8 Use  $\Delta$ / $\nabla$ / $\triangleright$  or 0 – 9, +10 to input the address or name, then press ENTER.**

"Setup Proxy" menu appears.

**9 Use  $\Delta$ / $\nabla$  to select "Port", then press ENTER or  $\triangleright$ .**

"Enter Proxy Port" menu appears.

**10 Use  $\Delta$ / $\nabla$ / $\triangleright$  or 0 – 9 to input the port, then press ENTER.**

The Proxy settings are completed.

## Other network settings

### Network Control

Set the network function On/Off during standby.

#### 1 Press MENU.

Turns on the Menu settings mode and the Menu appears on the display (see [page 11](#) "Menu map").



#### 2 Use $\Delta$ / $\nabla$ to select "Network" – "Network Control", then press ENTER or $\triangleright$ .

"Network Control" menu appears.

#### 3 Use $\Delta$ / $\nabla$ to select "On", then press ENTER or $\triangleright$ .

**On** Network is on during standby. Main unit operable with a network compatible controller. Shortens the time before the network connection is completed.

- When "Network Control" is set to "On", the power display lights orange.
- More power is consumed when in standby (Power consumption: 3 W).

**Off** Suspend network function during standby. It will take slightly longer till the network connection is completed.

- The minimum amount of power is consumed when in standby (Power consumption: 0.3 W).
- This is the default setting.

#### 4 Press MENU.

The display returns to normal.

### Friendly Name

The Friendly Name (personalized name) is the name of this unit displayed on the network (Maximum 63 characters).

#### 1 Press MENU.

Turns on the Menu settings mode and the Menu appears on the display (see [page 11](#) "Menu map").

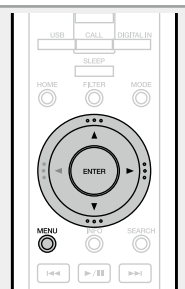

#### 2 Use $\Delta$ / $\nabla$ to select "Network" – "Friendly Name", then press ENTER or $\triangleright$ .

"Friendly Name" menu appears.

#### 3 Use $\Delta$ / $\nabla$ to select the friendly name (Marantz NA-11S1), then press ENTER.

#### 4 Edit a friendly name.

- For character input, see [page 40](#).

### Resetting the friendly name to the default setting

In step 3, select "Default" and press ENTER.

### Last.fm Display

Set whether or not to display Last.fm item on the menu.

#### 1 Press MENU.

Turns on the Menu settings mode and the Menu appears on the display (see [page 11](#) "Menu map").

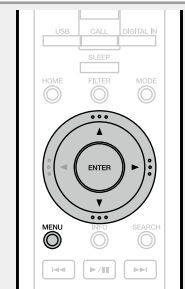

#### 2 Use $\Delta$ / $\nabla$ to select "Network" – "Last.fm Display", then press ENTER or $\triangleright$ .

"Last.fm Display" appears.

#### 3 Use $\Delta$ / $\nabla$ to select "Show" or "Hide", then press ENTER or $\triangleright$ .

**Show** Last.fm items will be displayed.

**Hide** Last.fm items will not be displayed.

## Setting the audio [Audio]

This unit is equipped with a sound quality adjusting function which allows users to enjoy the desired playback sound quality.

- This setting remains effective even if the power is turned off.

### Noise Shaper

Digital feedback is used to improve the low-sound linearity and the noise characteristics of the audible band.

Although no difference is observed in the measured values, the sound quality is changed, allowing users to specify a favorite sound quality.

#### 1 Press MENU.

Turns on the Menu settings mode and the Menu appears on the display ([page 11](#) "Menu map").

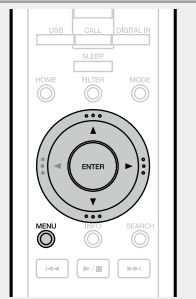

#### 2 Use $\Delta$ / $\nabla$ to select "Audio" – "Noise Shaper", then press ENTER or $\triangleright$ .

"Noise Shaper" menu appears.

#### 3 Use $\Delta$ / $\nabla$ to select "On" or "Off", then press ENTER or $\triangleright$ .

The setting is entered.

#### NOTE

The Noise Shaper function is disabled during playback of a 32 kHz sampling frequency source and DSD.

### DC Filter

This filter is effective in preventing excessive speaker vibration when playing music source where audio with extremely low noise characteristics has been recorded. (The cut frequency is set at 1.7 Hz.)

#### 1 Press MENU.

Turns on the Menu settings mode and the Menu appears on the display ([page 11](#) "Menu map").

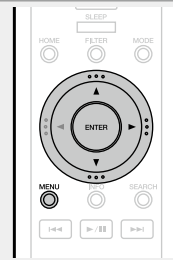

#### 2 Use $\Delta$ / $\nabla$ to select "Audio" – "DC Filter", then press ENTER or $\triangleright$ .

"DC Filter" menu appears.

#### 3 Use $\Delta$ / $\nabla$ to select "On" or "Off", then press ENTER or $\triangleright$ .

The setting is entered.

#### NOTE

- The DC Filter function is disabled during playback of a 32 kHz sampling frequency source and DSD.
- The "Noise Shaper", "DC Filter" and filter characteristics have a last memory function. These settings remain in memory even if the power is turned off.

### Digital Out (Setting for the digital output)

#### 1 Press MENU.

Turns on the Menu settings mode and the Menu appears on the display ([page 11](#) "Menu map").

#### 2 Use $\Delta$ / $\nabla$ to select "Audio" – "Digital Out", then press ENTER or $\triangleright$ .

"Digital Out" menu appears.

#### 3 Use $\Delta$ / $\nabla$ to select "On" or "Off", then press ENTER or $\triangleright$ .

- When "Digital Out" is set to "Off", the digital out off indicator lights on the display.

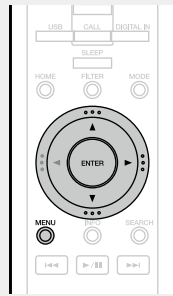

## Phase (analog output phase switching)

Switches the output signal phase for balanced outputs. The unit's balanced output conforms to USA system. This setting must be set to "Inverted" in order to execute balanced outputs to a European system amplifier with a different (inverted) phase.

### 1 Press MENU.

Turns on the Menu settings mode and the Menu appears on the display (page 11 "Menu map").

### 2 Use $\Delta$ / $\nabla$ to select "Audio" – "Phase", then press ENTER or $\triangleright$ . "Phase" menu appears.

### 3 Use $\Delta$ / $\nabla$ to select "Normal" or "Inverted", then press ENTER or $\triangleright$ .





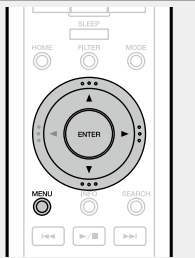





**Normal** USA system.

**Inverted** European system.



## Operation

Here, we explain functions and operations that let you make better use of this unit.

- Preparation  [page 21](#)
- Operations possible during playback  [page 21](#)
- Network audio playback  [page 23](#)
- Favorite function  [page 29](#)
- iPod playback  [page 30](#)
- USB memory device playback  [page 32](#)
- AirPlay function  [page 34](#)
- Remote play function  [page 36](#)
- Web control function  [page 37](#)
- Using as a D/A converter  [page 39](#)
- Other functions  [page 40](#)

# Operation

This section provides information on playback operation procedures.

## Preparation

### Turning the power on

Press **⏻** (on/standby).

Power is turned on and the STANDBY indicator goes off.

- You can also switch the power to standby by pressing **⏻ ON/STANDBY** on the main unit.

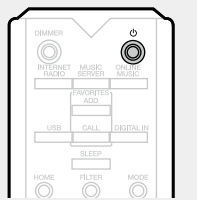

- When you turn on the power of this unit for the first time after purchasing it, the "Quick Setup" menu starts up. For details on "Quick Setup" operations, see the separate "Getting Started".
- If you cancelled "Quick Setup" menu or changed the network environment, perform "Menu" – "Quick Setup".

### Turning the power to standby mode

Press **⏻** (on/standby).

The unit enters standby mode.

- STANDBY indicator  
Normal standby : Red  
"Network Control" – "On" : Orange  
iPod charge standby : Orange

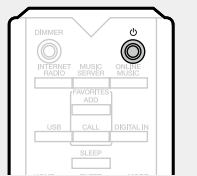

#### NOTE

Power continues to be supplied to some of the circuitry even when the power is in the standby mode. When leaving home for long periods of time, unplug the power cord from the power outlet.

#### ❑ Completely turning off the power

Unplug the power cord from the wall outlet.

## Operations possible during playback

### Selecting the input source

#### ❑ Selecting the input source using the main unit

#### 1 Press INPUT.

The display changes to the input source selection screen.

#### 2 Press $\Delta$ / $\nabla$ to select the input source.

The input source is switched each time the button is pressed.

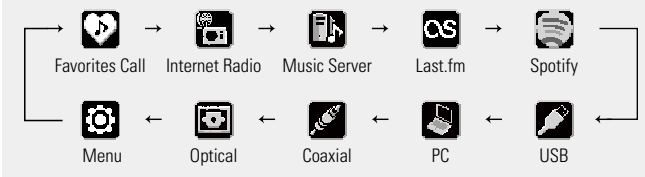

With this unit, you can play back music files stored on your iPhone/iPod touch and music from iTunes ([page 34](#) "AirPlay function").

#### ❑ Selecting the input source using the remote control

Press the input source select button (INTERNET RADIO, MUSIC SERVER, ONLINE MUSIC, USB, DIGITAL IN).

- The desired input source can be selected directly.
- The input source is switched as follows each time **DIGITAL IN** is pressed.

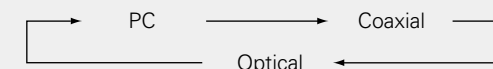
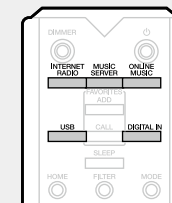

- The input source is switched as follows each time **ONLINE MUSIC** is pressed.

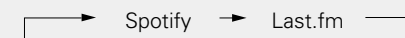



## Setting the sleep timer

Use this function to automatically switch the power to the standby mode after a specific amount of time (minutes).

Press **SLEEP** during playback and select the setting time.

- The sleep timer can be set to up to 90 minutes, in steps of 10 minutes.
- After about 3 seconds, the setting is entered and the display returns to as it was before.



### Canceling the sleep timer

Either press **SLEEP** to select "Sleep ► OFF" or press **ON/STANDBY**.

### To check the time remaining until the sleep timer is activated

Press **SLEEP**.

## Switching the illumination lamp setting

The illumination lamps on the both sides of the unit main panel can be turned on or off.

- The default setting is "On".

Press and hold **DIMMER** for 2 seconds or longer.

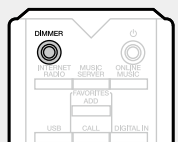

- The on/off setting changes as follows with each press of the button.

On ← → Off

- This can also be set by pressing **DIMMER** on the main unit.

## Switching the display's brightness

Press **DIMMER**.

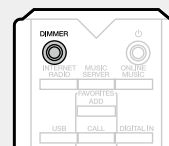

- The display brightness is adjusted each time **DIMMER** is pressed as shown below.

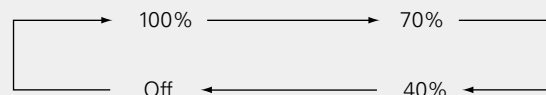

- When the display brightness is set to "Off", the DISPLAY OFF indicator lights on the display.



If you operate the buttons when the display brightness is set to "Off", the display temporarily lights at "100%" brightness level.

## Listening with headphones

Plug the headphones (sold separately) into the headphone jack (PHONES).

### Adjusting the Volume

Turn **LEVEL** on the main unit.

#### NOTE

To prevent hearing loss, do not raise the volume level excessively when using headphones.

## Switching the filter characteristics

2 filter characteristic types can be selected for DSD source, and for PCM source. The 2 filter characteristics types are explained below.

Filter Type	PCM source	DSD source
Filter 1	Offers a short impulse response for both pre-echo and post-echo. Suitable for large-information-content audio. Produces a deep sound image with clearly-defined positional relationships of the audio sources.	This is a direct mode in which there is no filtering versus the DSD data (Super Audio CD recording signal). The original source data is reproduced as it is, along with the original texture and space.
Filter 2	This filter offers asymmetrical impulse response. The post-echo is slightly longer than the pre-echo. Resembles analog sound quality.	DSD data exceeding 100 kHz is attenuated. Also equipped with DACs for normal-phase and inverted-phase signals (23 each). The asymmetrical DAC operation gives priority to the resolution, resulting in a smoother sound.

Press **FILTER**.

- The setting cycles through the 2 modes (Filter 1/Filter 2) as shown below each time the button is pressed.

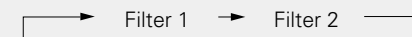
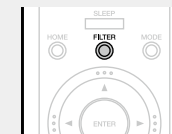

#### NOTE

The "Noise Shaper", "DC Filter" and filter characteristics have a last memory function. These settings remain in memory even if the power is turned off.

# Network audio playback

Follow this procedure to play Internet radio stations or music files stored on a computer.

- ❑ **About the Internet Radio function** (🔗 [page 46](#))
- ❑ **About Music server** (🔗 [page 46](#))
- ❑ **About Last.fm** (🔗 [page 47](#))
- ❑ **About Spotify** (🔗 [page 47](#))

## Listening to Internet Radio

### 1 Prepare for playback.

- ① Check the network environment, then turn on this unit's power (🔗 [page 21](#) "Turning the power on").
- ② If settings are required, make the "Setting the network [Network]" (🔗 [page 15](#)).

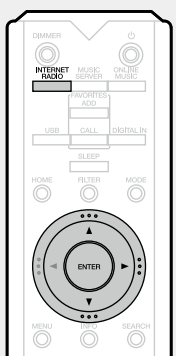

### 2 Press **INTERNET RADIO** to switch the input source to "Internet Radio".

- For details on selecting the input source using the unit buttons, see "Selecting the input source using the main unit" (🔗 [page 21](#)).

### 3 Press $\Delta \nabla$ to select the item you want to play, then press **ENTER** or $\triangleright$ .

### 4 Repeat step 3 until the station list is displayed.

The station list is displayed.

- Any characters that cannot be displayed are replaced with "." (period) or " " (space).

### 5 Press $\Delta \nabla$ to select the station, then press **ENTER** or $\triangleright$ .

Playback starts once buffering reaches "100%".



- There are many Internet radio stations on the Internet, and the quality of the programs they broadcast as well as the bit rate of the tracks varies widely. Generally, the higher the bit rate, the higher the sound quality, but depending on the communication lines and server traffic, the music or audio signals being streamed may be interrupted. Inversely, lower bit rates mean a lower sound quality but less tendency for the sound to be interrupted.
- "Server Full" or "Connection Down" is displayed if the station is busy or not broadcasting.

### ❑ Switching the display

#### Press **INFO** during Internet radio reception.

The broadcast station information and signal format bit rate are displayed.



### ❑ Recently played Internet Radio stations

Recently played Internet Radio stations can be selected from "Recently Played". Up to 20 stations can be stored in "Recently Played".

### 1 On a top menu of the Internet Radio station, press $\Delta \nabla$ to select "Recently Played", then press **ENTER** or $\triangleright$ .

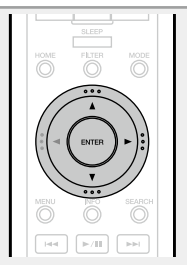

### 2 Press $\Delta \nabla$ to select the item you want to play, then press **ENTER** or $\triangleright$ .

### ❑ Searching stations by keyword (Alphabetic strings)

#### 1 Press $\Delta \nabla$ to select "Search by Keyword", then press **ENTER** or $\triangleright$ .

#### 2 Use $\Delta \nabla \triangleright$ or **0 - 9, +10** to input the characters, then press **ENTER**.

- For character input, see [page 40](#).

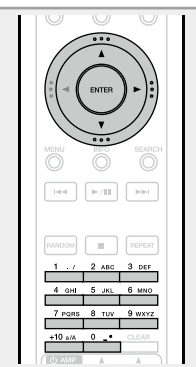

### ❑ Registering Internet Radio stations as your favorites

You can register your favorite Internet stations in the Favorite List (🔗 [page 29](#)).

### ❑ Internet radio operation

Operation buttons	Function
<b>FAVORITES ADD</b>	Registration to the Favorite list
<b>FAVORITES CALL</b>	Call from the Favorite list
$\Delta \nabla \triangleleft \triangleright$	Cursor operation (Up/Down/Left/Right)
<b>ENTER</b>	Enter
<b>MENU</b>	Menu
<b>SEARCH</b>	Character search*
<b>■</b>	Stop

- \* Press **SEARCH**, then press **ENTER** to select the first letter you want to search mode.



If the list is not in alphabetical order, you may not be able to perform a character search.

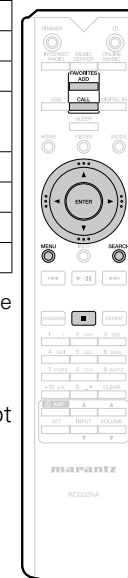

## Applying media sharing settings

Here, we apply the settings to share music files stored on a PC and NAS on the network.

### Sharing media stored on a PC

If you are using a media server, be sure to apply this setting first.

### When using Windows Media Player 12 (Windows 7, Windows 8)

#### NOTE

Perform this procedure after changing the control panel display to "Category".

- 1** In the PC's "Control Panel", select "Network and Internet" – "Choose homegroup and sharing options".
- 2** Select the "Stream my pictures, music, and videos to all devices on my home network" check box and select "Choose media streaming options".
- 3** Select "Allowed" in the drop-down list for "Marantz NA-11S1".
- 4** Select "Allowed" in the drop-down list for "Media programs on this PC and remote connections...".
- 5** Click "OK" to finish.

### When using Windows Media Player 11

- 1** Start up Windows Media Player 11 on the PC.
- 2** Select "Media Sharing" in the "Library".
- 3** Click the "Share my media" check box, select "Marantz NA-11S1", and then click "Allow".
- 4** As you did in step 3, select the icon of the device (other PCs and mobile devices) you want to use as a media controller, and then click "Allow".
- 5** Click "OK" to finish.

### Sharing media stored on a NAS device

Change settings on the Network Attached Storage (NAS) device to allow this unit and other devices (PCs and mobile devices) used as media controllers to access the NAS. For details, see the owner's manual that came with the NAS.

## Playing files stored on a PC and NAS

Use this procedure to play music files or playlists.

### 1 Prepare for playback.

- ① Check the network environment, then turn on this unit's power ([page 21](#) "Turning the power on").
- ② If settings are required, make the "Setting the network [Network]" ([page 15](#)).
- ③ Prepare the computer ([page 24](#) "Applying media sharing settings", [page 46](#) "About Music server").



### 2 Press **MUSIC SERVER** to switch the input source to "Music Server".

- For details on selecting the input source using the unit buttons, see "Selecting the input source using the main unit" ([page 21](#)).

### 3 Press $\Delta \nabla$ to select the server including the file to be played, then press **ENTER** or $\triangleright$ .

### 4 Press $\Delta \nabla$ to select the search item or folder, then press **ENTER** or $\triangleright$ .

### 5 Repeat step 4 until the file is displayed.

### 6 Press $\Delta \nabla$ to select the file, then press **ENTER** or $\triangleright$ . Playback starts once buffering reaches "100%".



- Connections to the required system and specific settings must be made in order to play music files ([page 8](#)).
- Before starting, you must launch the computer's server software and set the files as server contents. For details, see the operating instructions of your server software.
- The order in which the tracks/files are displayed depends on the server specifications. If the tracks/files are not displayed in alphabetical order due to the server specifications, searching by the first letter may not work properly.
- WMA Lossless files can be played when using a server supporting transcoding, such as Windows Media Player Ver. 11 or later.

#### NOTE

When playing back music files with your PC or NAS connected through wireless LAN, audio may be interrupted depending on your wireless LAN environment. In this case, play back music files with your PC or NAS connected through wired LAN.

#### **Playing repeatedly (Repeat playback)** ([page 32](#))

#### **Playing random order (Random playback)** ([page 32](#))

#### **Switching the display**

##### During playback, press **INFO**.

- The display switches each time **INFO** is pressed.

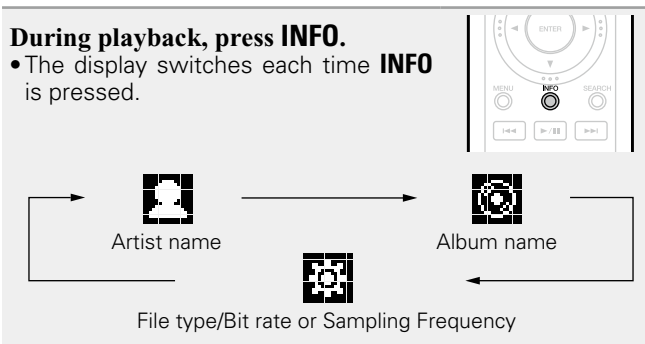

#### **Music server operation**

Operation buttons	Function
<b>FAVORITES ADD</b>	Registration to the Favorite list
<b>FAVORITES CALL</b>	Call from the Favorite list
$\Delta \nabla \triangleleft \triangleright$	Cursor operation
<b>ENTER</b>	Enter
<b>MENU</b>	Menu
<b>SEARCH</b>	Character search*1
$\lll, \ggg$ (Press and release)	Skip to previous or next file
$\lll, \ggg$ (Press and hold)	Fast-reverse the file / Fast-forward the file*2
$\triangleright / \parallel$	Playback / Pause
$\blacksquare$	Stop
<b>RANDOM</b>	Random playback ( <a href="#">page 32</a> )*3
<b>REPEAT</b>	Repeat playback ( <a href="#">page 32</a> )

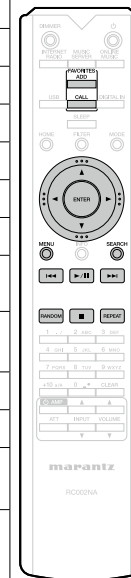

- \*1 Press **SEARCH**, then press **ENTER** to select the first letter you want to search mode.
- \*2 This function is available while an MP3 / WAV / AAC / FLAC file is being played back.
- \*3 During random playback of files stored on a PC, each time playback of a track is completed, another track is randomly selected for playback from tracks in the folder.



- If the list is not in alphabetical order, you may not be able to perform a character search.
- Depending on the server being used, some functions may be limited.

## Listening to Last.fm

Last.fm radio is not available in all countries. Please check [www.last.fm/hardware](http://www.last.fm/hardware) for more information. You'll also need a subscription. Get one today at [www.last.fm/subscribe](http://www.last.fm/subscribe).

### 1 Prepare for playback.

- ① Make sure this unit is connected to the Internet, then turn on this unit's power (see [page 21](#) "Turning the power on").
- ② If settings are required, make the "Setting the network [Network]" (see [page 15](#)).

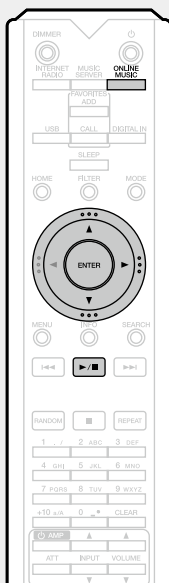

### 2 Press **ONLINE MUSIC** to switch the input source to "Last.fm".

- For details on selecting the input source using the unit buttons, see "Selecting the input source using the main unit" (see [page 21](#)).
- If you do not have a Last.fm account, press  $\nabla$  to select "I am new to Last.fm". Then press **ENTER** or  $\triangleright$ . Create an account in accordance with the instructions on the display.

### 3 If you have a Last.fm account, press $\triangle\nabla$ to select "I have a Last.fm account". Then press **ENTER** or $\triangleright$ .

### 4 Use $\triangle\nabla$ to enter your username and password.

- For character input, see [page 40](#).

### 5 After inputting the username and password, select "login", then press **ENTER**.

If the username and password match, the top menu for Last.fm is displayed.

- The types of characters that can be input are as shown below.

- Username**  
 [Lower case characters]  
 abcdefghijklmnopqrstuvwxyz  
 [Upper case characters]  
 ABCDEFGHIJKLMNOPQRSTUVWXYZ  
 [Symbols] \_ -  
 [Numbers] 0123456789
- Password**  
 [Lower case characters]  
 abcdefghijklmnopqrstuvwxyz  
 [Upper case characters]  
 ABCDEFGHIJKLMNOPQRSTUVWXYZ  
 [Symbols]  
 ! " # \$ % & ' ( ) \* + , - . / : ; < = > ? @ [ \ ] ^ \_ ` { | }  
 ~ (Space)  
 [Numbers] 0123456789

### 6 Use $\triangle\nabla$ to select menu and then press **ENTER** or $\triangleright$ .

- Popular Tags** Play popular tags in your area.
- Popular Artists** Play popular artists tags in your area.
- Your Recent Stations** Play your recent stations.
- Your Recommended Radio** Play your recommended radio.
- Your Library** Play your library.
- Your Friend's Radio** Play your friend's radio.
- Your Top Artists** Play your top Artists.
- Search Tag Radio** You can search station by Tag.
- Search Artist Radio** You can search station by Artist.

### 7 Use $\triangle\nabla$ to select a station, and press **ENTER**, $\triangleright$ or **▶/||** to start playback. Playback starts.

**8** When you press **▷** during playback, the following menu appears.

**Love this track** Loving tracks improves your Last.fm recommendations, and you can optionally share them on popular social networks.

**Ban this track** If you ban a track, we won't play it again. You can undo this on the Last.fm website.

**Scrobbling** Scrobbling sends the tracks you played to your Last.fm account. You can see charts of the music you've been listening to, get recommendations for new music and events in your area and share your listening tastes with your friends. You can turn this service on or off using this option. The more you scrobble, the better your recommendations will become.

**NOTE**  
The password should be no longer than 90 characters

**Log out**  
Disassociate this unit from your Last.fm account.

**1** While the Last.fm top menu is displayed, use **△▽** to select “Log Out”, then press **ENTER**.

**2** Use **△▽** to select “OK”, then press **ENTER**.

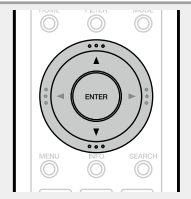

**Switching the display**

**During playback, press INFO.**  
The file type/bit rate, artist name and album name are displayed.



**Last.fm operation**

Operation buttons	Function
△▽◀▶	Cursor operation
ENTER	Enter
MENU	Menu
▶▶I	Next (cue)
▶/II	Playback
■	Stop



**Listening to Spotify**

Introduce your Marantz to a whole new world of music. With Spotify, you can enjoy instant access to millions of songs. A Spotify Premium subscription is required. For details, see the Spotify homepage. <http://www.spotify.com>

- 1 Prepare for playback.**
- Make sure this unit is connected to the Internet, then turn on this unit's power (see page 21 “Turning the power on”).
  - If settings are required, make the “Setting the network [Network]” (see page 15).
  - Complete step 4 and obtain a Spotify account.
    - If you already have a Spotify account, you do not need to obtain a new account. Use your existing Spotify account.

**2 Press ONLINE MUSIC to switch the input source to “Spotify”.**

For details on selecting the input source using the unit buttons, see “Selecting the input source using the main unit” (see page 21).

**3 If you have a Spotify account, then press ENTER.**

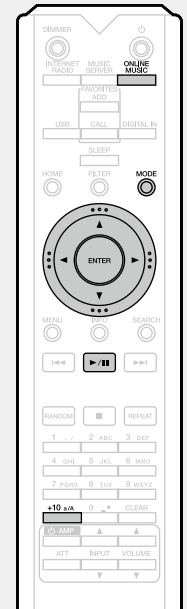

**4** Use  $\Delta \nabla \triangleright$  to enter your username and password.

**[Upper case characters/Numbers/Symbols]**  
 ABCDEFGHIJKLMNOPQRSTUVWXYZ  
 ÄÅÁÀÃÄÆÇÐÈÉÊËÌÍÎÏÑÒÓÔÕÖØÙÚÛÜÝÞ  
 0123456789  
 ! " # \$ % & ' ( ) \* + , ; < = >  
**[Lower case characters/Numbers/Symbols]**  
 abcdefghijklmnopqrstuvwxyz  
 äåáàãäæçðèéêëìíîïñòóôõöøùúûüýþÿß  
 0123456789  
 . @ - \_ / : ~ ? [ \ ] ^ ' { | }

- When you enter the Spotify account and Search text, you can use number buttons to select characters with diacritical marks. You can also select the base character and then press **MODE** to change diacritical marks.
- For character input, see [page 40](#).

**5** After inputting the username and password, select “login”, then press **ENTER**.

When the user name and password match, the registration confirmation message scrolls.

- To continue, press **ENTER** and select “[accept]”. The Spotify Top menu is displayed. To go back, press  $\triangleleft$  and select “[back]”.

**6** Use  $\Delta \nabla$  to select menu and then press **ENTER** or  $\triangleright$ .

- Search** Searches for tracks, artists and albums by entering keywords.
- What’s New** Displays the list of the latest albums.
- Starred** Displays the list of the starred tracks.
- Playlists** Displays the playlists for Spotify.
- Accounts** Manages accounts (Log out, Add new user, Switch to user).

**7** Use  $\Delta \nabla$  to select a station, and press **ENTER**,  $\triangleright$  or  $\triangleright/\parallel$  to start playback. Playback starts.

**8** When you press  $\triangleright$  during playback, the following menu appears.

- Star this track** Adds a star to the selected track.
- Browse “Artist name”** Displays the list of albums by the artist of the track that is being played back.
- Browse “Album name”** Displays the list of tracks on the album that is being played back.

**Switching the display**

**During playback, Press INFO.**  
 The display switches between artist name and album title each time the button is pressed.



**Spotify operation**

Operation buttons	Function
<b>HOME</b>	Move Top Menu
$\Delta \nabla \triangleleft \triangleright$	Cursor operation
<b>ENTER</b>	Enter
<b>INFO</b>	Display switches
$\mathbb{I} \ll, \gg \mathbb{I}$	Next/Previous (cue)
$\triangleright/\parallel$	Playback/Pause
$\blacksquare$	Stop
<b>RANDOM</b>	Random playback
<b>REPEAT</b>	Repeat playback

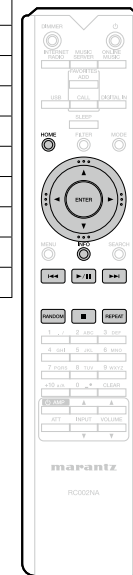



## Favorite function

This section provides information on the Favorite function.

- The Favorite function allows you to register your favorite broadcast stations and files in the Favorite List in advance so that you can call and listen to the stations or files right away, whenever you want.
- The contents that you can register and call are Internet radio station and music server.
- You can register up to 50 items in the Favorite List.

### Registering stations or files to the favorites list

- 1 Press **FAVORITES ADD** while the Internet radio station or file to register is played back.  
"Favorite" menu appears.

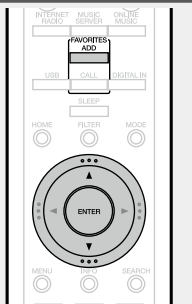

- 2 Press  $\Delta \nabla$  to select a number to register the station or file, and press **ENTER**.  
"Added To Favorites" is displayed and the registration is completed.

### Calling stations or files from the favorites list

- 1 Press **FAVORITES CALL**.  
The Favorite list appears.
- 2 Press  $\left| \ll \gg \right|$  or  $\Delta \nabla$  to select the station or file that you want to call, and press **ENTER**.  
The respective function starts up and playback starts.

- Press **0 – 9, +10** to call files registered to the Favorite list by number.

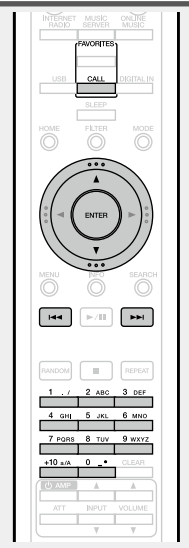

- To switch between registered stations and files during playback**  
Press  $\left| \ll \gg \right|$  or  $\Delta \nabla$ .

### Deleting stations or files from the favorite list

- 1 Press **FAVORITES CALL**.  
The Favorite list appears.
- 2 Press  $\Delta \nabla$  to select the station or file that you want to delete, and press **CLEAR**.
- 3 When the prompt "Delete?" appears, press **ENTER**.  
"Deleted" is displayed and the deletion is completed.

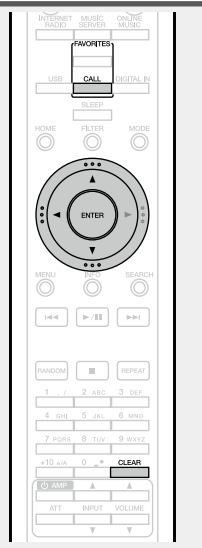

- To cancel the operation**  
Press  $\leftarrow$ .



## iPod playback

The unit can play back music stored on an iPod, iPod touch, iPod classic, iPod nano and iPhone.

□ iPod (page 45)

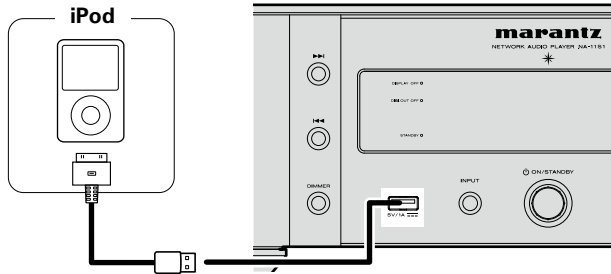

To connect an iPod to this unit, use the iPod cable supplied with the iPod.

### NOTE

- When connecting an iPhone to this unit, keep the iPhone at least 20 cm away from this unit. If the iPhone is kept closer to this unit and a telephone call is received by the iPhone, noise may be output from this device.
- If the iPod is connected using an iPod cable (commercially available) that is longer than 2 m, sound may not be played correctly. In this case, use a genuine iPod cable, or a cable that is shorter than 1 m.

## Playing an iPod

**1** Press **POWER** (on/standby) to turn on power to the main unit.

**2** Press **USB** to switch the input source to “USB”.

- For details on selecting the input source using the unit buttons, see “Selecting the input source using the main unit” (page 21).

**3** Press **MODE** to select the display mode.

The display mode switches each time **MODE** is pressed.

- There are two modes for displaying the contents recorded on the iPod.

### Remote mode

Display iPod information on the display of this unit.

### Direct mode

Display iPod information on the iPod screen.

- “Direct iPod” is displayed on the display of this unit.

Display mode		Remote mode	Direct mode
Display location		Main unit display	iPod display
Playable files	Audio file	✓	✓
	Video file		✓*
Active buttons	Remote control and main unit	✓	✓
	iPod		✓

\* Only audio is played back.

- The default display mode setting is “Direct mode”.



**4** Use **Δ**/**∇** to select the item, then press **ENTER** to select the music file to be played.

**5** Press **▶/||**. Playback starts.

### NOTE

- 1st generation iPod nano and iPod video do not have Direct mode support.
- Marantz will accept no responsibility whatsoever for any loss of iPod data.
- Depending on the type of iPod and the software version, some functions may not operate.

□ iPod operation

Operation buttons	Function
<b>MODE</b>	Switch between the Remote mode and the Direct mode
<b>Δ</b> / <b>∇</b>	Cursor operation (up/down)
<b>◀</b>	Display the menu or return to the previous menu
<b>ENTER</b> or <b>▶</b>	Enter the selection or plays the track
<b>◀◀</b> , <b>▶▶</b> (Press and release)	Play the track from the beginning / Play the next track
<b>◀◀</b> , <b>▶▶</b> (Press and hold)	Fast-reverse the track / Fast-forward the track
<b>▶  </b>	Play the track / Pause the track
<b>■</b>	Stop
<b>REPEAT</b>	Switch the repeat function
<b>RANDOM</b>	Switch the shuffle function

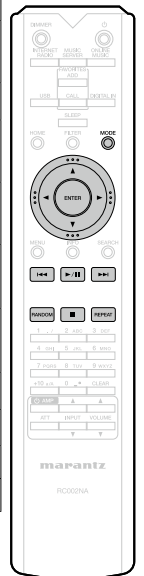

## Switching the display

During playback, press **INFO**.

- The display switches each time **INFO** is pressed (Remote mode only).



Artist name



Album name

## Playing repeatedly (Repeat playback)

([page 32](#))

(Remote mode only)

## Playing random order (Random playback)

([page 32](#))

## Disconnecting the iPod

**1** Press **⏻** (on/standby) to set the standby mode.

**2** Disconnect the iPod from the USB port.

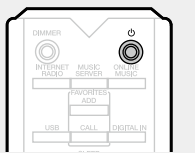

## Charging the iPod

You can charge your iPhone/iPod by connecting it to the USB port.

### Standby charging

If the unit enters power standby mode while the iPod/iPhone is charging, the unit will switch to standby charging mode, and the iPod/iPhone will continue to be charged. When in standby charging mode, the power display light turns orange.

When the iPhone/iPod is fully charged, the unit automatically stops supplying power for charging and enters normal power standby mode, and the power display light turns red.

## Supported iPod models

### • iPod classic



iPod classic  
80GB



iPod classic  
160GB (2007)



iPod classic  
160GB (2009)

### • iPod nano



iPod nano  
3rd generation  
(video)  
4GB 8GB



iPod nano  
4th generation  
(video)  
8GB 16GB



iPod nano  
5th generation  
(video camera)  
8GB 16GB



iPod nano  
6th generation  
8GB 16GB



iPod nano  
7th generation  
16GB

### • iPod touch



iPod touch  
1st generation  
8GB 16GB 32GB



iPod touch  
2nd generation  
8GB 16GB 32GB



iPod touch  
3rd generation  
32GB 64GB



iPod touch  
4th generation  
8GB 32GB 64GB



iPod touch  
5th generation  
32GB 64GB

### • iPhone



iPhone  
4GB 8GB 16GB



iPhone 3G  
8GB 16GB



iPhone 3GS  
8GB 16GB 32GB



iPhone 4  
8GB 16GB 32GB



iPhone 4S  
16GB 32GB 64GB



iPhone 5  
16GB 32GB 64GB

## USB memory device playback

You can playback music stored on a USB memory device using this unit.

□ **USB memory device** (🔗 [page 45](#))

### Playing files stored on USB memory devices

#### 1 Connect the USB memory device to the USB port.



#### 2 Press **⏻** (on/standby) to turn on power to the main unit.

#### 3 Press **USB** to switch the input source to “USB”.

• For details on selecting the input source using the unit buttons, see “Selecting the input source using the main unit” (🔗 [page 21](#)).

#### 4 Press **△▽** to select the file or folder, then press **ENTER** or **▷**.

#### 5 Press **△▽** to select the file, then press **ENTER**, **▷** or **▶/II**. Playback starts.

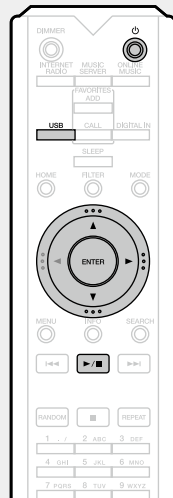

- If the USB memory device is divided into multiple partitions, only the top partition can be selected.
- This unit is compatible with MP3 files conforming to “MPEG-1 Audio Layer-3” standards.
- Marantz does not guarantee that all USB memory devices will operate or receive power. When using a portable USB connection type HDD of the kind to which an AC adapter can be connected to supply power, use the AC adapter.

#### NOTE

- USB memory devices will not work via a USB hub.
- It is not possible to connect and use a computer via the USB port of this unit using a USB cable.
- Do not use an extension cable when connecting a USB memory device. This may cause radio interference with other devices.
- Files can be read from a USB memory device by connecting the device to this unit. The file reading time varies according to the amount of data saved on the USB memory device. Several minutes may be required to read the maximum permissible number of files and folders.
- Note that Marantz will accept no responsibility whatsoever for any problems arising with the data on a USB memory device when using this unit in conjunction with the USB memory device.

### Removing the USB memory device

#### 1 Press **⏻** (on/standby) to set the standby mode.

#### 2 Check that the communication indicator on the USB memory device is not flashing, then pull out the USB memory device.



#### NOTE

Do not remove the USB memory device from the unit when the USB memory communication indicator is flashing. Doing so may damage the USB memory device, or may corrupt the files recorded on the USB memory device.

### Playing repeatedly (Repeat playback)

#### Press **REPEAT**.

Repeat playback starts.

- Each time you press **REPEAT**, the repeat mode is toggled as shown below.

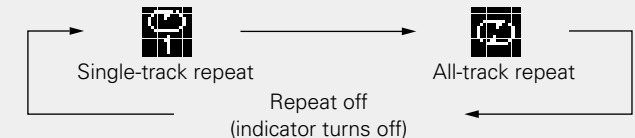

(Single-track repeat)	Only 1 track plays repeatedly.
(All-track repeat)	All tracks within the current playback folder are repeated.
Repeat off (indicator turns off)	Normal playback resumes.

### Playing random order (Random playback)

#### Press **RANDOM**.

The indicator on the display is lighted and all tracks in the current playback folder are randomly played back.

#### □ **Canceling random playback**

Press **RANDOM**.

The indicator on the display turns off.

❑ **USB operation**

Operation buttons	Function
△▽	Cursor operation
ENTER or ▷	Enter / Playback
◀	Display the menu or return to the previous menu
<b>SEARCH</b>	Character search*1
⏮, ⏭ (Press and release)	Skip to previous or next file
⏮, ⏭ (Press and hold)	Fast-reverse the file / Fast-forward the file*2
▶/⏸	Playback / Pause
■	Stop
<b>RANDOM</b>	Random playback*3
<b>REPEAT</b>	Repeat playback



❑ **Switching the display**

**During playback, press INFO.**

- The display switches each time **INFO** is pressed.

- \*1 Press **SEARCH**, then press **ENTER** to select the first letter you want to search mode.
- \*2 This function is available while an MP3 / WAV / AAC / FLAC file is being played back.
- \*3 During random playback of files stored on a USB memory device, each time playback of a track is completed, another track is randomly selected for playback from tracks in the folder.



If the list is not in alphabetical order, you may not be able to perform a character search.

## AirPlay function

Enjoy music from your iTunes library with high quality sound anywhere in your home.

Use the Apple Remote app\* for iPhone, iPod touch and iPad to control iTunes from any room in your home.

\* Available as a free download from the App Store.

### Streaming music stored in iPhone, iPod touch, or iPad directly to the unit

If you update your "iPhone/iPod touch/iPad" to iOS 4.2.1 or later, you can stream music stored in your "iPhone/iPod touch/iPad" directly to this unit.

#### 1 Startup iPhone, iPod touch, or iPad music or iPod app.

 is displayed on the iPhone, iPod touch or iPad screen.

#### 2 Tap the AirPlay icon .

Set "Network Control" ([page 17](#)) to "On" for this unit.

#### NOTE

When "Network Control" is set to "On", the unit consumes slightly more power in standby mode than when it is in "Network Control - Off" mode. It is still a small amount, however.

#### 3 Select the speaker you want to use.

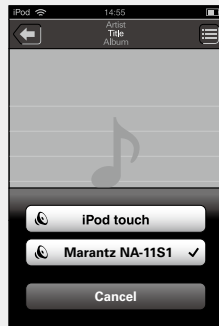
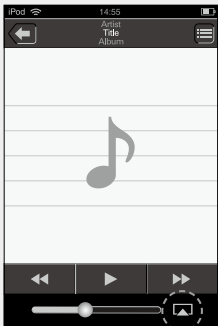

### Playing iTunes music on this unit

#### 1 Install iTunes 10, or later, on a Mac or PC that is connected to the same network as this unit.

#### 2 Turn this unit ON.

Set "Network Control" ([page 17](#)) to "On" for this unit.

#### NOTE

When "Network Control" is set to "On", the unit consumes more standby power.

#### 3 Launch iTunes and click the AirPlay icon displayed in the lower right of the window and select this unit from the list.

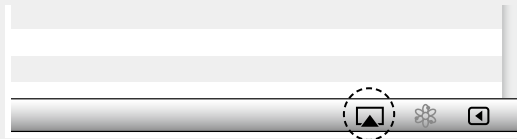

#### 4 Choose a song and click play in iTunes.

The music will stream to this unit.

### Selecting multiple speakers (devices)

You can easily stream music from iTunes to multiple speakers in your home.

#### 1 Click the AirPlay icon and select "Multiple Speakers" from the list.

#### 2 Check the speakers you want to use.

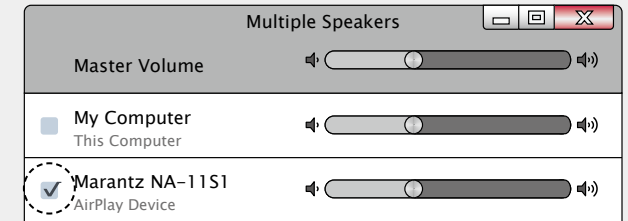

## □ Perform iTunes playback operations with the remote control unit of this unit

You can use your Marantz remote control to play and pause iTunes, as well as skip to next and previous tracks.

**1** Select “Edit” – “Preferences...” on the menu.

**2** Select “Devices” in the iTunes setting window.

**3** Check “Allow iTunes audio control from remote speakers”, and then click “OK”.

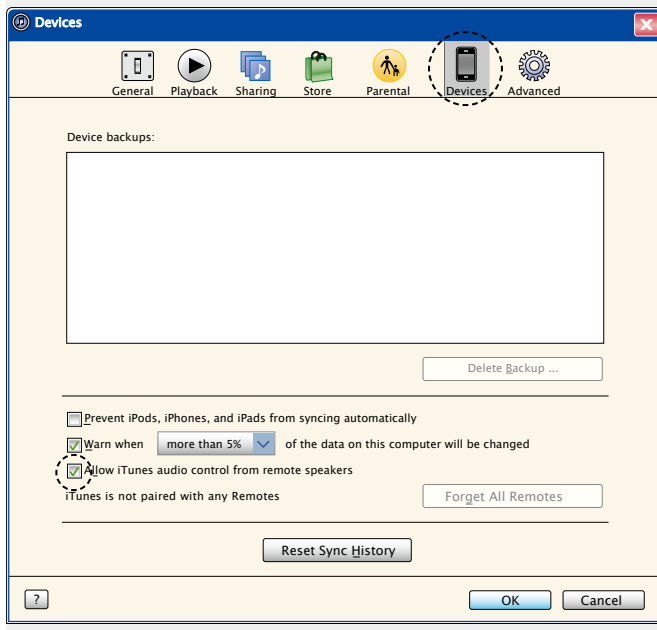

- Input source will be switched to “AirPlay” when AirPlay playback is started.
- You can stop AirPlay playback by pressing the ◀ or choosing other input source.
- To see artist name or album name together, press **INFO**.
- For information about how to use iTunes, also see the Help for iTunes.
- The screen may differ depending on the OS and software versions.
- When you connect iPod to the USB connector during AirPlay playback, AirPlay playback stops.

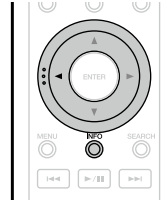

## Remote play function

You can use your home network to play back with this unit music files stored on PC, NAS, smartphones and portable audio players. In this case, you use PC, smartphones and portable audio players for operations.



- The relevant devices should comply with the DLNA (Digital Living Network Alliance) Ver. 1.5 standard.
- A wireless LAN environment is required for playing back music files on smartphones or portable audio players.
- For some smartphones, you must install an application for DLNA music playback.

### Roles each device plays

The following devices are used for Remote Play. As specified in the DLNA standard, these devices are called DMC, DMS or DMR according to their role.

Name	Device example	Role
<b>DMC</b> (Digital Media Controller)	<ul style="list-style-type: none"> <li>• PC</li> <li>• Smartphone</li> <li>• Portable audio player</li> </ul>	Performs Remote Play operations. DMC can also play back music files stored on these devices.
<b>DMS</b> (Digital Media Server)	<ul style="list-style-type: none"> <li>• PC</li> <li>• NAS (Network Attached Storage)</li> </ul>	Stores music files. Music files stored on these devices are played back with DMC.
<b>DMR</b> (Digital Media Renderer)	<ul style="list-style-type: none"> <li>• This unit</li> </ul>	Outputs audio of music files played back through Remote Play from speakers. DMR cannot perform playback operations.

### Files that can be played back

See "About Music server" ([page 46](#)).

## Settings required for each device

You must make settings on DMC and DMS for Remote Play. Make the following settings. Also see the owner's manual of each device for settings.

### Settings on PC and NAS

Make settings on PC and NAS to exchange data with DMR devices.

For settings, see "Applying media sharing settings" ([page 24](#)).

### Settings on smartphones

You must install an application for DLNA music playback on your smartphone to perform operations on DMS and this unit (DMR) with your smartphone. The applicable application differs according to your smartphone.



Some smartphones support DLNA music playback with the factory settings. See the owner's manual of your smartphone.

### Settings on portable audio players

Make settings so that this unit (DMR) can play back music files stored on your portable audio player. For settings, see the owner's manual of your portable player.

### Settings on this unit

Connect this unit to the DLNA network. You do not need to make other settings.

For the network connection, see the provided Getting Started, "Connecting to a home network (LAN)" ([page 8](#)) and "Setting the network [Network]" ([page 15](#)).

### Remote Play operations

Operations are different for each device, but the procedures for preparing for Remote Play are the same. The preparation procedures are shown below.

- 1 Turn on this unit.**
  - Make sure that this unit is connected to the network.
- 2 Display the music file playback screen on DMC.**
  - For PC, open Windows Media Player 12, etc.
  - For smartphones, switch to the music file playback mode.
- 3 Select the friendly name of this unit for the item that sets the playback device on the playback screen.**
  - The default friendly name of this unit is "Marantz NA-11S1".
- 4 Start playing back a music file on DMC.**
  - The function on this unit automatically switches to Music Server and the Remote Play mark () appears on the display. Remote Play starts.

### NOTE

During Remote Play, you cannot perform playback operations with this unit. Use the DMC device for these operations.

### To exit Remote Play

Press .  
The Remote Play mode ends.

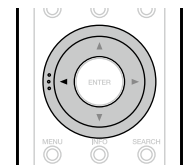

## Web control function

You can control this unit from a web control screen on a web browser.



- This unit and the PC need to be connected to the network properly (page 8 “Connecting to a home network (LAN)”) in order to use the web control function.
- Depending on the settings of your security-related software, you may not be able to access this unit from your PC. If this is the case, then change the settings of the security-related software.

### 1 Switch the “Network Control” setting to “On” (page 17).

### 2 Check the IP address of this unit with “Network Information”.



### 3 Start up the web browser.

### 4 Enter the IP address of this unit in browser’s address box.

For example, if the IP address of this unit is “192.168.100.19”, enter “http://192.168.100.19/”.

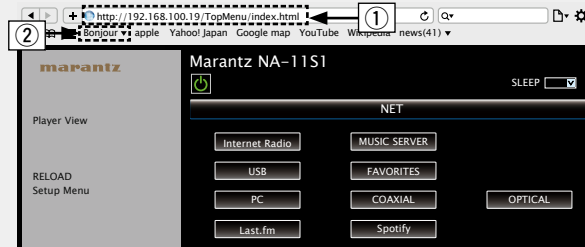

#### ① Entering the IP address.

- By adding this unit’s IP address to the browser’s bookmark, you can display the web control screen using the browser. If you are using a DHCP server and “Network Control” (page 17) is set to “Off”, turning the power on/off changes the IP address.

#### ② If you are using the Safari web browser, you can select “Bonjour” and directly access the unit’s web control screen from the overview section.

### 5 When the top menu is displayed, click on the menu item you want to operate.

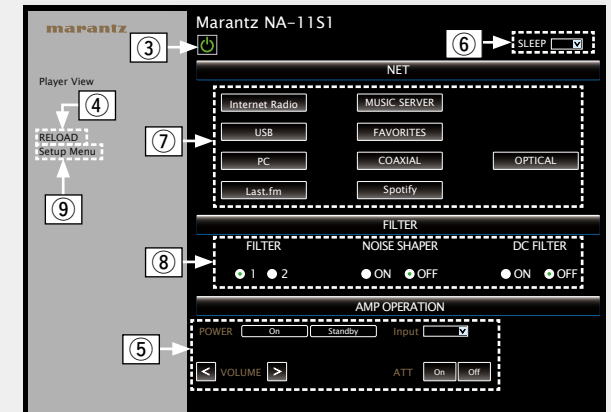

#### ③ Click when you perform a power operation of the unit.

#### ④ Click when you update to the latest information.

Normally, there is a change to the latest information each time you operate. When operating from the main unit, click this or else the screen will not be updated.

#### ⑤ Click to operate the Marantz amp connected by Remote connector cable (page 9).

#### ⑥ Click “v” to set the sleep timer function.

#### ⑦ Click a button to change the input source.

#### ⑧ Click an item to make a FILTER settings.

#### ⑨ Click when you operate the setup menu.



## 6 Operate.

【Network Setting】

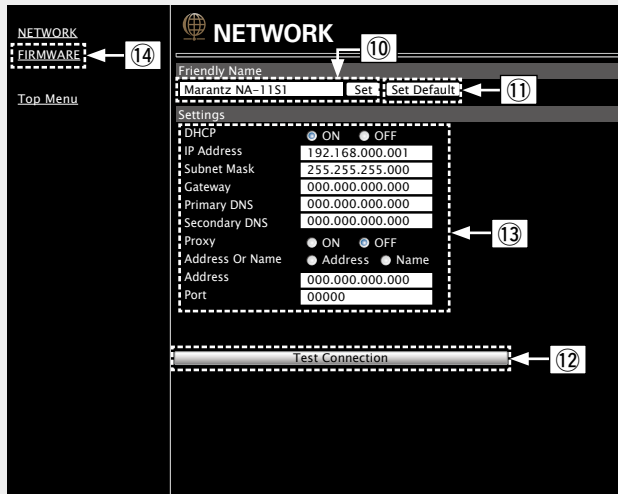

Friendly Name setting

- ⑩ To change the Friendly Name, enter the new name in the text box and click “Set”.
- ⑪ To reset the Friendly Name, click “Set Default”.

Network connection settings

- ⑫ Click to connect using the newly applied settings.
- ⑬ When changing DHCP/proxy settings, input or select for each item.
- ⑭ Click when you update firmware ([page 13](#)).

**NOTE**

- Items displayed may vary depending on selected items and connection status.
- After selecting each item, wait a moment for the display to be updated.
- To apply network connection settings, click “Test Connection” after making changes.

## Using as a D/A converter

Digital audio signals input from an external device or computer into this unit can be converted and output as analog signals using this unit (D/A converter).

### Connect and playback from a digital device (Coaxial/Optical)

Press **DIGITAL IN** to change the input source to “Coaxial” or “Optical”.

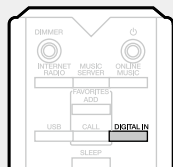

The input digital audio signal is displayed as shown.

“Coaxial PCM xxxx kHz” or “Optical PCM xxxx kHz”  
(xxxx indicates the sampling frequency.)

- If the sampling frequency cannot be detected, “Signal Unlock” will be displayed.

#### NOTE

- Linear PCM signals with sampling frequencies of 32 kHz, 44.1 kHz, 48 kHz, 64 kHz, 88.2 kHz, 96 kHz, 176.4 kHz and 192 kHz can be input in the unit.
- Do not input non-PCM signals, such as Dolby Digital, and DTS. This causes noise and could damage the speakers.
- If the sampling frequency switches, such as from A mode to B mode in a CS broadcast, muting may operate for 1 – 2 seconds, cutting the sound.

### Connecting and playing back from a computer (USB)

This unit can play both PCM source and DSD source.

#### □ Installing the dedicated driver

Before music files saved on a computer can be played on this unit, the dedicated driver must be downloaded from the Marantz website, and installed in the computer. However, drivers do not need to be installed for Mac OS.

#### NOTE

- The dedicated driver must be installed in the computer before this unit is connected to a computer. Operation will not occur correctly if connected to the computer before the dedicated driver has been installed. Moreover, if the computer is running Windows XP as its OS, the computer’s speed will decrease significantly, and a computer restart may be required.
- Operation may fail in some computer hardware and software configurations.

#### □ Computer (recommended system)

##### OS

- Windows® XP Service Pack3, Windows® Vista, Windows 7 or Windows 8
- Macintosh OSX 10.6.4 or later.

##### Software

- Server software supporting Windows Media Player® and iTunes.

##### USB

- USB 2.0: USB High speed/USB Audio Class V2.0



- DSD is a registered trademark.
- Microsoft, Windows XP, Windows Vista, Windows 7 and Windows 8 are either registered trademarks or trademarks of Microsoft Corporation in the United States and/or other countries.
- Apple, Macintosh and Mac OS are trademarks of Apple Inc., registered in the U.S. and other countries.

#### □ Connection

Use the rear panel USB port to connect this unit to a personal computer. For the connection procedure, refer to the “PC connection” ([page 7](#)) section.

Press **DIGITAL IN** to change the input source to “PC”.

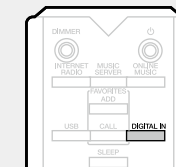

The input digital audio signal is displayed as shown.

“PC PCM xxxx kHz” or “PC DSD xxxx MHz”  
(xxxx indicates the sampling frequency.)

- If the sampling frequency cannot be detected, “Signal Unlock” will be displayed.
- When “PC/PCM xxxx kHz” is displayed on this unit, wait for approximately 10 seconds, and then start and operate the music playback software on the computer. This unit functions as a D/A converter.

#### NOTE

- Perform operations such as playback and pause on the computer. At this time, you cannot perform operations with buttons on this unit or the remote control.
- You can also control the volume and equalizer on the computer. Enjoy playing music at the desired volume.
- When this unit is functioning as a D/A converter, sound is not output from the computer’s speakers.
- If the computer is disconnected from this unit while the computer music playback software is running, the playback software may freeze. Always exit the playback software before disconnecting the computer.
- When an abnormality occurs on the computer, disconnect the USB cable and restart the computer.
- The supported sampling frequencies are 32 / 44.1 / 48 / 64 / 88.2 / 96 / 176.4 / 192 kHz (PCM) and 2.8224 MHz (DSD).
- The sampling frequency of the music playback software and sampling frequency displayed on this unit may differ.
- Use a cable that is 3 m or less to connect to the computer.
- If the computer you use is “Mac OS”, please check if the “USB High Speed Audio” format is set below “192000.0 Hz” using the “Audio MIDI Setup”.

## Other functions

### Inputting characters

On this unit, the names displayed for “Friendly Name” and search, screens can be changed as desired. For inputting characters, there are two methods, as shown below.

Method	Operations
Using the number buttons	<ul style="list-style-type: none"> <li>Operating with the remote control.</li> <li>Multiple characters are assigned to a button, and each time the button is pressed, a character is switched.</li> </ul>
Using the cursor buttons	<ul style="list-style-type: none"> <li>Operating with the remote control or the main unit.</li> <li>Use <math>\Delta</math> <math>\nabla</math> <math>\triangleleft</math> <math>\triangleright</math> and <b>ENTER</b> to input characters.</li> </ul>

#### □ Display of an input screen

##### [Friendly name input]



\* The current input character type is displayed.

a : Lower case

A : Upper case

1 : Numerics

ä : Lowercase characters with a diacritical mark

Ä : Uppercase characters with a diacritical mark

### Using the number buttons

**1** Display the screen for inputting characters.

**2** Place the cursor at the character to be changed with  $\triangleleft$   $\triangleright$ .

**3** Press **+10** to select the character type (upper case, lower case, or numeric characters), and press **0 – 9** to select the desired character.

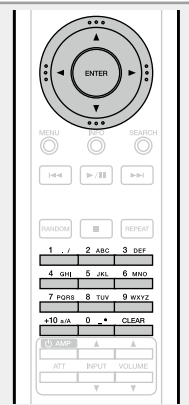

- When you enter the Spotify account and Search text, you can select character types with a diacritical mark.
- The types of characters that can be input are as shown below.

1 ./	1 . @ - _ / : ~	6 mno	m n o M N O 6
2 abc	a b c A B C 2	7 pqrs	p q r s P Q R S 7
3 def	d e f D E F 3	8 tuv	t u v T U V 8
4 ghi	g h i G H I 4	9 wxyz	w x y z W X Y Z 9
5 jkl	j k l J K L 5	0 .*	0 (Space) ! " # \$ % & ' ( ) * + , ; < = > ? [ \ ] ^ ` {   }

- Press **CLEAR** to delete the character.
- For entering the characters assigned to one number button continuously, press  $\triangleright$  to move the cursor to the right after entering a character then enter the next character.
- For entering characters assigned to separate buttons, press the number button continuously. The cursor automatically moves to the next position, and the entered character is registered.

**4** Repeat step 2 and 3 to change the name then press **ENTER** to register it.

**Example:** For changing characters from “POPS” to “ROCK”

- Place the cursor at “P”.  $\triangleright$  POPS
- Press **CLEAR**.  
“P” is deleted.  $\triangleright$  OPS
- Press **+10** to set the character type to upper case.
- Press **7 PQRS** three times.  $\triangleright$  ROPS
- Press  $\triangleright$  twice.  
“R” is automatically registered, and the cursor placed “P”.  $\triangleright$  ROPS
- Press **2 ABC** three times.  
“C” is input.  $\triangleright$  ROCKPS
- Press **5 JKL** twice.  
“C” is automatically registered, and “K” is input.  $\triangleright$  ROCKKPS
- Press  $\triangleright$  once.  
Place the cursor at “P”.  $\triangleright$  ROCKPS
- Press **CLEAR** twice.  
“P” and “S” are deleted.  $\triangleright$  ROCK■
- Press **ENTER** to register the input name.

## Using the cursor buttons

- 1** Display the screen for inputting characters.
- 2** Use ◀ ▶ to set the cursor to the character you want to change.
- 3** Use ▲ ▼ to change the character.



- The types of characters that can be input are as shown below.

### [Lower case characters]

abcdefghijklmnopqrstuvwxyz

### [Upper case characters]

ABCDEFGHIJKLMNOPQRSTUVWXYZ

[Symbols] ! " # \$ % & ' ( ) \* + , - . / : ; < = > ? @ [ \ ] ^ \_ ` { | } ~

[Numbers] 0 1 2 3 4 5 6 7 8 9 (Space)

- Press **CLEAR** to delete the character.
- Press ▶▶| to insert a space.

- 4** Repeat steps 2 and 3 to change the name then press **ENTER** to register it.

## Auto power on function

Press ▶▶|.

The unit's power turns on automatically, the previously selected source is played back.









## Last function memory

This stores the settings as they were immediately before going into the standby mode. When the power is turned back on, the settings are restored to as they were immediately before going into the standby mode.

## Information

---

Here, we list various information related to this unit.  
Please refer to this information as needed.

- Part names and functions  [page 43](#)
- Other information  [page 45](#)
- Explanation terms  [page 48](#)
- Troubleshooting  [page 50](#)
- Specifications  [page 54](#)
- Index  [page 55](#)

# Part names and functions

For buttons not explained here, see the page indicated in parentheses ( ).

## Front panel

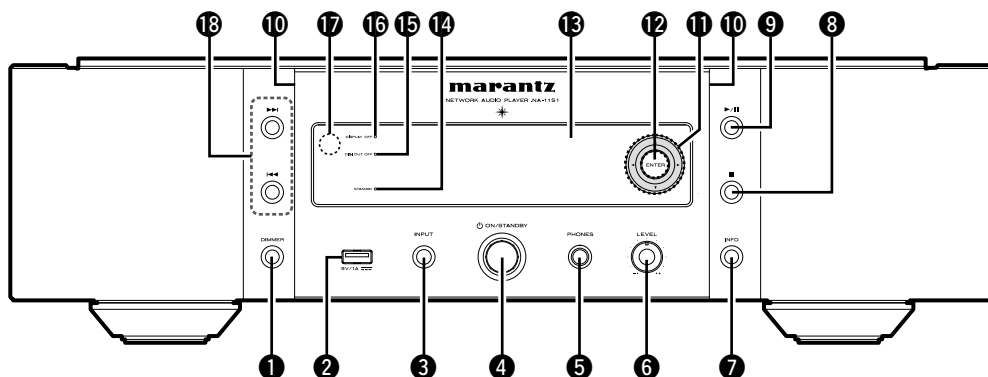

- ❶ **DIMMER button** ..... (22)
- ❷ **USB port** ..... (30, 32)  
Used to connect iPod or USB memory devices.
- ❸ **INPUT button** ..... (21, 54)  
Selects the input source.
- ❹ **Power operation switch (ON/STANDBY)** ..... (21)
- ❺ **Headphones jack (PHONES)** ..... (22)  
Used to connect headphones.
- NOTE**  
To prevent hearing loss, do not raise the volume level excessively when using headphones.
- ❻ **Headphone volume control knob (LEVEL)** ..... (22)
- ❼ **Information button (INFO)** ..... (23, 25, 27, 28, 31, 33, 35)
- ❽ **Stop button (■)** ..... (23, 25, 27, 28, 30, 33)
- ❾ **Play/Pause button (▶/||)** ..... (27, 28, 30, 32, 41)
- ❿ **Illumination lamp** ..... (22)
- ⓫ **Cursor buttons (Δ▽◀▶)** ..... (11, 12, 15, 18, 23, 29, 30, 32, 40)
- ⓬ **ENTER button** ..... (11, 12, 15, 18, 23, 29, 30, 32, 40)
- ⓭ **Display**  
Displays play status, settings, etc.
- ⓮ **STANDBY indicator** ..... (21)  
Turns power to this unit on and off (standby).  
The STANDBY indicator changes as shown below according to the status of the unit.
  - Power on : Off
  - Standby : Red
  - "Network Control" – "On" : Orange
  - iPod charge standby : Orange
- ⓯ **Digital out off indicator (DIGI. OUT OFF)** ..... (18)
- ⓰ **DISPLAY OFF indicator** ..... (22)
- ⓱ **Remote control sensor** ..... (4)
- ⓲ **Skip/Search buttons (|◀▶|)** ..... (29)

## Rear panel

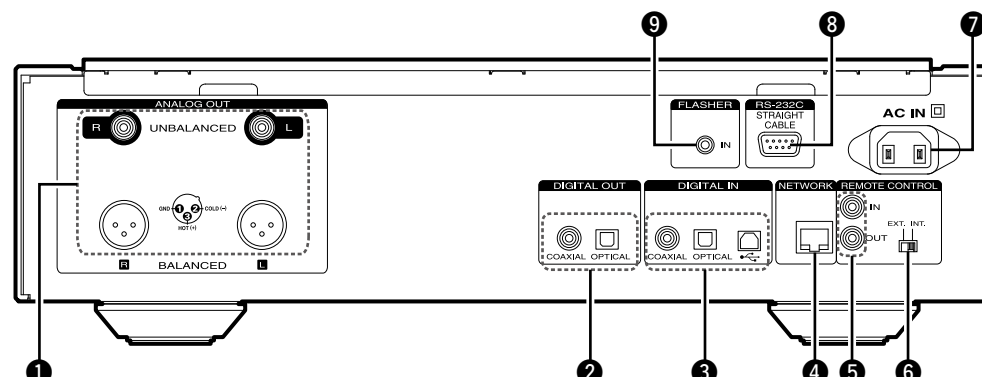

- ❶ **ANALOG OUT connectors (UNBALANCED/BALANCED)** ..... (6)
- ❷ **DIGITAL OUT connectors** ..... (7)
- ❸ **DIGITAL IN connectors** ..... (7)
- ❹ **NETWORK connector** ..... (8)
- ❺ **REMOTE CONTROL connectors (IN/OUT)** ..... (9)
- ❻ **External/Internal switch (EXT./INT.)** ..... (9)
- ❼ **AC inlet (AC IN)** ..... (10)
- ❽ **RS-232C connector** ..... (9)
- ❾ **FLASHER IN jack (IN)** ..... (9)

# Remote control

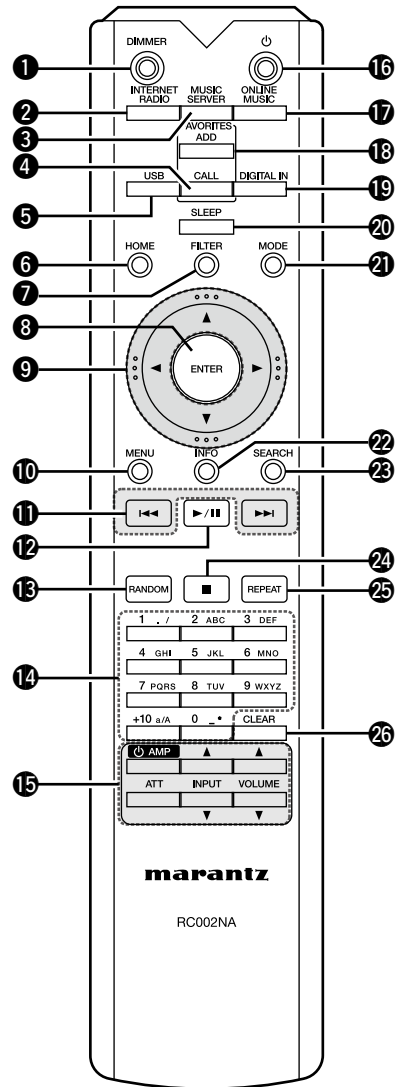

- ❶ DIMMER button ..... (22)
- ❷ INTERNET RADIO button ..... (21, 23)
- ❸ MUSIC SERVER button ..... (21, 25)
- ❹ FAVORITES CALL button ..... (23, 25, 29)
- ❺ USB button ..... (21, 30, 32)
- ❻ HOME button ..... (11, 28)
- ❼ FILTER button ..... (22)
- ❽ ENTER button ..... (11, 12, 15, 18, 23, 29, 30, 32, 40)
- ❾ Cursor buttons (▲▼◀▶) ..... (11, 12, 15, 18, 23, 29, 30, 32, 40)
- ❿ MENU button ..... (11, 12, 15, 18, 23, 25, 27)
- ⓫ Skip/Search buttons (◀▶) ..... (25, 27, 28, 29, 30, 33)
- ⓬ Play/Pause button (▶/⏸) ..... (27, 28, 30, 32, 41)
- ⓭ RANDOM button ..... (25, 28, 30, 32)
- ⓮ Number/Character buttons (0 – 9, +10) ..... (23, 40)
- ⓯ Amplifier operation buttons  
 AMP power button (⏻)  
 Attenuator button (ATT)  
 INPUT buttons (▲▼)  
 VOLUME buttons (▲▼)
- ⓶ POWER button (⏻) ..... (21)
- ⓷ ONLINE MUSIC button ..... (21, 26, 27)
- ⓸ FAVORITES ADD button ..... (23, 25, 29)
- ⓹ DIGITAL IN button ..... (21, 39)
- ⓺ SLEEP button ..... (22)
- ⓻ MODE button ..... (27, 30)
- ⓼ Information button (INFO) ..... (23, 25, 27, 28, 31, 33, 35)
- ⓽ SEARCH button ..... (23, 25, 33)
- ⓿ Stop button (■) ..... (23, 25, 27, 28, 30, 33)
- ⓾ REPEAT button ..... (25, 28, 30, 32)
- ⓿ CLEAR button ..... (29, 40, 41)



- The supplied remote control can operate Marantz amplifiers.
- When using it, also refer to the operating instructions of the other devices.

**NOTE**

The remote control may not operate some devices.

# Other information

## iPod



“Made for iPod” and “Made for iPhone” mean that an electronic accessory has been designed to connect specifically to iPod, or iPhone, respectively, and has been certified by the developer to meet Apple performance standards.

Apple is not responsible for the operation of this device or its compliance with safety and regulatory standards. Please note that the use of this accessory with iPod, or iPhone, may affect wireless performance.

AirPlay, the AirPlay logo, iPhone, iPod, iPod classic, iPod nano, iPod shuffle, and iPod touch are trademarks of Apple Inc., registered in the U.S. and other countries.

- Individual users are permitted to use iPhone, iPod, iPod classic, iPod nano, iPod shuffle, and iPod touch for private copy and playback of non-copyrighted contents and contents whose copy and playback is permitted by law. Copyright infringement is prohibited by law.

## USB memory device

Playing back music files recorded on a USB memory device.

### Important information

- Only USB memory devices conforming to mass storage class and MTP (Media Transfer Protocol) standards can be played on this unit.
- This unit is compatible with USB memory devices in “FAT16” or “FAT32” format.
- This unit is compatible with MP3 files conforming to “MPEG-1 Audio Layer-3” standards.
- File types that this unit can play back and specifications are shown below.

#### [Supported file types]

Supported file types	USB memory devices *1
<b>WMA</b> (Windows Media Audio)	✓*2
<b>MP3</b> (MPEG-1 Audio Layer-3)	✓
<b>WAV</b>	✓
<b>MPEG-4 AAC</b>	✓*3
<b>FLAC</b> (Free Lossless Audio Codec)	✓
<b>ALAC</b> (Apple Lossless Audio Codec)	✓

\*1 USB memory device

- This unit is compatible with MP3 ID3-Tag (Ver. 2) standard.
- This unit is compatible with WMA META tags.
- WAV format Quantization bit length: 16 or 24 bits.
- FLAC format Quantization bit length: 16 or 24 bits.

\*2 Copyright-protected files can be played on certain portable players compatible with MTP.

\*3 Only files that are not protected by copyright can be played on this unit.

Content downloaded from pay sites on the Internet are copyright protected. Also, files encoded in WMA format when ripped from a CD, etc. on a computer may be copyright protected, depending on the computer’s settings.

#### NOTE

File types that this unit does not support are not displayed.

#### [Compatible formats]

	Sampling frequency	Bit rate	Bit length	Extension
<b>WMA</b> (Windows Media Audio)	32/44.1/ 48 kHz	48 – 192 kbps	–	.wma
<b>MP3</b> (MPEG-1 Audio Layer-3)	32/44.1/ 48 kHz	32 – 320 kbps	–	.mp3
<b>WAV</b>	32/44.1/ 48/88.2/ 96/176.4/ 192 kHz	–	16 / 24 bit	.wav
<b>MPEG-4 AAC</b>	32/44.1/ 48 kHz	16 – 320 kbps	–	.aac/ .m4a/ .mp4
<b>FLAC</b> (Free Lossless Audio Codec)	32/44.1/ 48/88.2/ 96/176.4/ 192 kHz	–	16 / 24 bit	.flac
<b>ALAC</b> (Apple Lossless Audio Codec) *	32/44.1/ 48/88.2/ 96 kHz	–	16 / 24 bit	.m4a

\* Copyright [2012] [D&M Holdings, Inc.]

Licensed under the Apache License, Version 2.0 (the “License”); you may not use this file except in compliance with the License. You may obtain a copy of the License at <http://www.apache.org/licenses/LICENSE-2.0>

#### NOTE

Variable Bit rate (VBR) is not supported (when playback is possible, the time display in the display window will speed up and slow down).



### ❑ Maximum Number of Playable Files and Folder

The limits on the number of folders and files that can be displayed by this unit are as follows.

Item	Media	USB memory devices
Memory capacity		FAT16 : 2 GB, FAT32 : 2 TB
Number of folder directory levels *1		8 levels
Number of folders		500
Number of files *2		5000

\*1 The limited number includes the root folder.

\*2 The allowable number of files may differ according to the USB memory device capacity and the file size.

## Network audio

### Important information

#### ❑ About the Internet Radio function

- Internet radio refers to radio broadcasts distributed over the Internet. Internet radio stations from around the world can be received.
- This unit is equipped with the following Internet radio functions:
  - Stations can be selected by genre and region.
  - Internet radio stations in MP3 and WMA (Windows Media Audio) format can be listened to.
  - Your favorite radio stations can be registered by accessing an exclusive Marantz Internet radio URL from a Web browser on a computer.
- The function is managed for individual users, so you must provide your MAC or e-mail address.  
Exclusive URL: <http://www.radiomarantz.com>
- The radio station database service may be suspended without notice.
- This unit's Internet radio station list is created using a radio station database service (vTuner). This database service provides a list edited and created for this unit.

#### ❑ About Music server

This function lets you play music files and playlists (m3u, wpl) stored on a computer (music server) connected to this unit via a network.

With this unit's network audio playback function, connection to the server is possible using one of the technologies below.

- Windows Media Player Network Sharing Service
- Windows Media DRM10

#### [Types of files that can be played back by each function]

	Internet radio	Music server *1
<b>WMA</b> (Windows Media Audio)	✓	✓
<b>MP3</b> (MPEG-1 Audio Layer-3)	✓	✓
<b>WAV</b>		✓
<b>MPEG-4 AAC</b>		✓*2
<b>FLAC</b> (Free Lossless Audio Codec)		✓
<b>ALAC</b> (Apple Lossless Audio Codec)		✓

A server or server software compatible with distribution in the corresponding formats is required to play music files via a network.

#### \*1 Music server

- This unit is compatible with MP3 ID3-Tag (Ver. 2) standard.
- This unit is compatible with WMA META tags.
- If the image size (pixels) of an album artwork exceeds 500×500 (WMA/MP3/WAV/FLAC) or 349×349 (MPEG-4 AAC), then music may not be played back properly.

#### \*2 Only files that are not protected by copyright can be played on this unit.

Content downloaded from pay sites on the Internet are copyright protected. Also, files encoded in WMA format when ripped from a CD, etc. on a computer may be copyright protected, depending on the computer's settings.

[Playback file specifications]

	Sampling frequency	Bit rate	Bit length	Extension
<b>WMA</b> (Windows Media Audio)	32/44.1/ 48 kHz	48 – 192 kbps	–	.wma
<b>MP3</b> (MPEG-1 Audio Layer-3)	32/44.1/ 48 kHz	32 – 320 kbps	–	.mp3
<b>WAV</b>	32/44.1/ 48/88.2/ 96/176.4/ 192 kHz	–	16 / 24 bit	.wav
<b>MPEG-4 AAC</b>	32/44.1/ 48 kHz	16 – 320 kbps	–	.aac/ .m4a/ .mp4
<b>FLAC</b> (Free Lossless Audio Codec)	32/44.1/ 48/88.2/ 96/176.4/ 192 kHz	–	16 / 24 bit	.flac
<b>ALAC</b> (Apple Lossless Audio Codec) *	32/44.1/ 48/88.2/ 96 kHz	–	16 / 24 bit	.m4a

\* Copyright [2012] [D&M Holdings. Inc.]  
Licensed under the Apache License, Version 2.0 (the "License"); you may not use this file except in compliance with the License. You may obtain a copy of the License at <http://www.apache.org/licenses/LICENSE-2.0>

**NOTE**

- Particularly when you play back large music files, depending on your wireless LAN environment, the playback sound may be interrupted. In this case, make the wired LAN connection.
- Variable Bit rate (VBR) is not supported (when playback is possible, the time display in the display window will speed up and slow down).

**□ About Last.fm**

Last.fm learns what you love... and it's a great way to discover new music.

Your new Marantz Network Audio Player is very clever. You can create a free Last.fm profile when you start using your Marantz Network Audio Player and magically keep track of all the songs you hear.

When you sign in at [www.last.fm](http://www.last.fm), you can see your top music charts, view thousands of reviews, biographies and artwork, and get recommendations for local performances you won't want to miss.

With an affordable subscription you can enjoy an endless choice of personalised ad-free radio stations. Check out [www.last.fm/subscribe](http://www.last.fm/subscribe) today for more details.

Your subscription also gives you access to Last.fm radio on a great range of music products, including your Marantz Network Audio Player. This feature is not available in all countries. Visit [www.last.fm/hardware](http://www.last.fm/hardware) to find out more.

**□ About Spotify**

Introduce your Marantz to a whole new world of music. With Spotify, you can enjoy instant access to millions of songs.

A Spotify Premium subscription is required.

For details, see the Spotify homepage.

<http://www.spotify.com>

# Explanation terms

## A

### AirPlay

AirPlay sends (plays) contents recorded in iTunes or on an iPhone/iPod touch to a compatible device via the network.

### ALAC (Apple Lossless Audio Codec)

This is a codec for lossless audio compression method developed by Apple Inc. This codec can be played back on iTunes, iPod or iPhone. Data compressed to approximately 60 – 70% can be decompressed to exactly the same original data.

### App Store

App Store is a site that sells application software for such devices as the iPhone or iPod Touch, and is operated by Apple Inc.

## B

### Bit rate

This expresses the read amount per 1 second of video/audio data recorded in a disc. A larger number means higher sound quality, but also means a larger file size.

## D

### DLNA

DLNA and DLNA CERTIFIED are trademarks and/or service marks of Digital Living Network Alliance.

Some contents may not be compatible with other DLNA CERTIFIED® products.

### DSD (Direct-Stream Digital)

This is an audio data recording method. Audio signals are stored on media such as Super Audio CDs as delta-sigma modulated digital audio. The signal is composed of single-bit values at a sampling rate of 2.8224MHz.

## F

### FLAC

FLAC stands for Free lossless Audio Codec, and is a lossless free audio file format. Lossless means that the audio is compressed without any loss in quality. The FLAC license is as shown below.

Copyright (C) 2000,2001,2002,2003,2004,2005,2006,2007,2008,2009 Josh Coalson

Redistribution and use in source and binary forms, with or without modification, are permitted provided that the following conditions are met:

- Redistributions of source code must retain the above copyright notice, this list of conditions and the following disclaimer.
- Redistributions in binary form must reproduce the above copyright notice, this list of conditions and the following disclaimer in the documentation and/or other materials provided with the distribution.
- Neither the name of the Xiph.org Foundation nor the names of its contributors may be used to endorse or promote products derived from this software without specific prior written permission.

THIS SOFTWARE IS PROVIDED BY THE COPYRIGHT HOLDERS AND CONTRIBUTORS "AS IS" AND ANY EXPRESS OR IMPLIED WARRANTIES, INCLUDING, BUT NOT LIMITED TO, THE IMPLIED WARRANTIES OF MERCHANTABILITY AND FITNESS FOR A PARTICULAR PURPOSE ARE DISCLAIMED. IN NO EVENT SHALL THE FOUNDATION OR CONTRIBUTORS BE LIABLE FOR ANY DIRECT, INDIRECT, INCIDENTAL, SPECIAL, EXEMPLARY, OR CONSEQUENTIAL DAMAGES (INCLUDING, BUT NOT LIMITED TO, PROCUREMENT OF SUBSTITUTE GOODS OR SERVICES; LOSS OF USE, DATA, OR PROFITS; OR BUSINESS INTERRUPTION) HOWEVER CAUSED AND ON ANY THEORY OF LIABILITY, WHETHER IN CONTRACT, STRICT LIABILITY, OR TORT (INCLUDING NEGLIGENCE OR OTHERWISE) ARISING IN ANY WAY OUT OF THE USE OF THIS SOFTWARE, EVEN IF ADVISED OF THE POSSIBILITY OF SUCH DAMAGE.

## I

### iTunes

iTunes is the name of the multimedia player provided by Apple Inc. It enables management and playback of multimedia contents including music and movies. iTunes supports many main file formats including AAC, WAV, and MP3.

## M

### MP3 (MPEG Audio Layer-3)

This is an internationally standardized audio data compression scheme, using the "MPEG-1" video compression standard. It compresses the data volume to about one eleventh its original size while maintaining sound quality equivalent to a music CD.

### MPEG (Moving Picture Experts Group), MPEG-2, MPEG-4

These are the names for digital compression format standards used for the encoding of video and audio.

Video standards include "MPEG-1 Video", "MPEG-2 Video", "MPEG-4 Visual", "MPEG-4 AVC". Audio standards include "MPEG-1 Audio", "MPEG-2 Audio", "MPEG-4 AAC".

## S

### Sampling frequency

Sampling involves taking a reading of a sound wave (analog signal) at regular intervals and expressing the height of the wave at each reading in digitized format (producing a digital signal).

The number of readings taken in one second is called the "sampling frequency". The larger the value, the closer the reproduced sound is to the original.

## V

### vTuner

This is a free online content server for Internet radio. Note that usage fees are included in upgrade costs.

For inquiries about this service, visit the vTuner site below.

vTuner website: <http://www.radiomarantz.com>

This product is protected by certain intellectual property rights of Nothing Else Matters Software and BridgeCo. Use or distribution of such technology outside of this product is prohibited without a license from Nothing Else Matters Software and BridgeCo or an authorized subsidiary.

## W

### Windows Media DRM

This is a copyright protection technology developed by Microsoft.

Content providers are using the digital rights management technology for Windows Media contained in this device (WM-DRM) to protect the integrity of their content (Secure Content) so that their intellectual property, including copyright, in such content is not misappropriated. This device uses WM-DRM software to play Secure Content (WM-DRM Software). If the security of the WM-DRM Software in this device has been compromised, owners of Secure Content (Secure Content Owners) may request that Microsoft revoke the WM-DRM Software's right to acquire new licenses to copy, display and/or play Secure Content. Revocation does not alter the WM-DRM Software's ability to play unprotected content.

A list of revoked WM-DRM Software is sent to your device whenever you download a license for Secure Content from the Internet or from a PC.

Microsoft may, in conjunction with such license, also download revocation list onto your device on behalf of Secure Content Owners.

**Windows Media Player Ver. 11 or later**

This is a media player distributed free of charge by Microsoft Corporation.

It can be used to play playlists created with Windows Media Player Ver. 11 or later as well as files in such formats as WMA, DRM WMA, MP3 and WAV.

**WMA (Windows Media Audio)**

This is audio compression technology developed by Microsoft Corporation.

WMA data can be encoded using Windows Media® Player.

To encode WMA files, only use applications authorized by Microsoft Corporation. If you use an unauthorized application, the file may not work properly.

# Troubleshooting

If a problem occurs first check the following:

1. Are the connections correct?

2. Is the set being operated as described in the owner's manual?

3. Are the other devices operating properly?

If this unit does not operate properly, check the items listed in the table below. If the problem persists, there may be a malfunction.

In this case, disconnect the power immediately and contact your retail outlet.

## [General]

Symptom	Cause	Countermeasure	Page
Set does not operate properly.	• External noise or interference is causing the set to malfunction.	• Reset the microprocessor.	<a href="#">54</a>
Display not lit and sound not produced when power switched to on.	• Power cord not plugged in securely.	• Check the connections on the set's rear panel and the connection of the power plug to the power outlet.	<a href="#">10</a>
Display lit but sound not produced.	• Wrong input source selected.	• Select the appropriate input source.	<a href="#">21</a>
Display is off.	• The Dimmer setting is set to "Off".	• Set to something other than "Off".	<a href="#">22</a>
For stereo sources, the positions of the instruments are inverted.	• The connections of the speaker cables or input cables are inverted.	• Check and remedy the connections.	<a href="#">6</a>
Power turns off suddenly and STANDBY indicator flashes red. (Flashes at 0.25 second intervals)	• Set is damaged.	• Turn off the power and contact a Marantz service center.	–

Symptom	Cause	Countermeasure	Page
"No Network Connection" is displayed.	• The network is not properly set up.	• Select a source other than the network function. • Perform "Quick Setup".	<a href="#">21</a>  Getting Started

## [Internet radio/Music server/iPod/USB memory device]

Symptom	Cause	Countermeasure	Page
When a USB memory device is connected, "USB" is not displayed.	• The set cannot recognize a USB memory device.	• Check the connection.	<a href="#">32</a>
	• A USB memory device not conforming to mass storage class or MTP standards is connected.	• Connect a USB memory device conforming to mass storage class or MTP standards.	<a href="#">45</a>
	• A USB memory device that the set cannot recognize is connected.	• This is not a malfunction. Marantz does not guarantee that all USB memory devices will operate or receive power.	<a href="#">32</a>
iPod cannot be played.	• USB memory device is connected via USB hub.	• Connect the USB memory device directly to the USB port.	<a href="#">32</a>
	• The input source is set to something other than "USB".	• Switch the input source to "USB".	<a href="#">21</a>
The file names are not displayed properly ("...", etc.).	• Cable is not properly connected.	• Reconnect.	<a href="#">30</a>
	• Characters that cannot be displayed are used.	• This is not a malfunction. On this unit, characters that cannot be displayed are replaced with a "." (period).	–
	• Invalid tags are used for files within the USB memory device connected to this unit.	• Use tags that are supported by this unit.	<a href="#">45</a>

Symptom	Cause	Countermeasure	Page
Files on a USB memory device cannot be played.	• USB memory device is in a format other than FAT16 or FAT32.	• Set the format to FAT16 or FAT32. For details, refer to the USB memory device's operating instructions.	<a href="#">45</a>
	• USB memory device is divided into multiple partitions.	• When divided into multiple partitions, only files stored in the top partition can be played.	–
	• Files are stored in a non-compatible format.	• Record the files in a compatible format.	<a href="#">45</a>
	• You are attempting to play a file that is copyright protected.	• Files that are copyright protected cannot be played on this set.	<a href="#">45</a>
Internet radio cannot be played.	• LAN cable is not properly connected or network is disconnected.	• Check the connection status.	<a href="#">8</a>
	• Program is being broadcast in non-compatible format.	• Only Internet radio programs in MP3 and WMA can be played on this set.	<a href="#">46</a>
	• The computer's or router's firewall is activated.	• Check the computer's or router's firewall settings.	–
	• Radio station is not currently broadcasting. • IP address is wrong.	• Choose a radio station that is currently broadcasting. • Check the set's IP address.	<a href="#">23</a> <a href="#">15</a>
Files stored on a computer cannot be played.	• Files are stored in a non-compatible format.	• Record in a compatible format.	<a href="#">46</a>
	• You are attempting to play a file that is copyright protected.	• Files that are copyright protected cannot be played on this set.	<a href="#">46</a>
"Unsupported" is displayed.	• The format of the audio signal input is not compatible with the device.	• Check the settings of the PC or player software. • If the computer you use is "Mac OS", please check if the "USB High Speed Audio" format is set below "192000.0 Hz" using the "Audio MIDI Setup".	– –

Symptom	Cause	Countermeasure	Page
Music stored on a NAS cannot be played.	• DLNA server function is disabled.	• If you use a NAS in conformity with the DLNA standard, enable the DLNA server function in the NAS setting.	–
	• NAS that does not conform with the DLNA is used.	• If you use a NAS that does not conform with the DLNA standard, play the music via a PC. Set Windows Media Player's media sharing function and add NAS to the selected play folder.	<a href="#">24</a>
	• The connection is restricted.	• If connection is restricted, set audio equipment as the connection target.	–
	Server is not found, or it is not possible to connect to the server.	• The computer's or router's firewall is activated. • Computer's power is not turned on. • Server is not running. • Set's IP address is wrong.	• Check the computer's or router's firewall settings. • Turn on the power. • Launch the server. • Check the set's IP address.
Cannot connect to favorite radio stations.	• Radio station is not currently broadcasting. • Radio station is not currently in service.	• Wait a while before trying again. • It is not possible to connect to radio stations that are no longer in service.	– –
A list of broadcasting stations is not displayed.	• Connection to the network is unstable.	• Reconnect to the network or redo the "Network" setting in the menu.	<a href="#">8</a> , <a href="#">15</a>



Symptom	Cause	Countermeasure	Page
For some radio stations, "Server Full" or "Connection Down" is displayed and station cannot be connected to.	<ul style="list-style-type: none"> <li>Station is congested or not currently broadcasting.</li> </ul>	<ul style="list-style-type: none"> <li>Wait a while before trying again.</li> </ul>	–
Sound is broken during playback.	<ul style="list-style-type: none"> <li>Network's signal transfer speed is slow or communications lines or radio station is congested.</li> </ul>	<ul style="list-style-type: none"> <li>This is not a malfunction. When playing broadcast data with a high bit rate, the sound may be broken, depending on the communications conditions.</li> </ul>	–
Sound quality is poor or played sound is noisy.	<ul style="list-style-type: none"> <li>File being played has a low bit rate.</li> </ul>	<ul style="list-style-type: none"> <li>This is not a malfunction.</li> </ul>	–

**[Last.fm]**

Symptom	Cause	Countermeasure	Page
Cannot login to Last.fm. ("Subscription required" is displayed.)	<ul style="list-style-type: none"> <li>Login authentication error.</li> <li>If a nonsubscriber user accesses it. Or when the listening limitation exceeds it.</li> </ul>	<ul style="list-style-type: none"> <li>Enter the correct username and password and retry login.</li> <li>You need to be a paid Last.fm subscriber to listen to this. Visit <a href="http://www.last.fm/subscribe">www.last.fm/subscribe</a> to upgrade.</li> </ul>	–
Cannot play back music. ("Library empty" is displayed.)	<ul style="list-style-type: none"> <li>No music data to be played back.</li> </ul>	<ul style="list-style-type: none"> <li>Visit <a href="http://www.last.fm/download">www.last.fm/download</a> and install the Scrobber to add the music you've played to your profile and make this feature work.</li> </ul>	–

Symptom	Cause	Countermeasure	Page
Cannot play back music. ("No more tracks" is displayed.)	<ul style="list-style-type: none"> <li>When you played all tunes of the playlist.</li> </ul>	<ul style="list-style-type: none"> <li>Select another playlist.</li> </ul>	–
Cannot access the Last.fm. ("No network Connection" is displayed.)	<ul style="list-style-type: none"> <li>Cannot connect to the network.</li> </ul>	<ul style="list-style-type: none"> <li>Check the network environment.</li> </ul>	<a href="#">8</a>
Cannot access the Last.fm. ("Not available in your country" is displayed.)	<ul style="list-style-type: none"> <li>You are accessing the network from a country where Last.fm radio is not available.</li> </ul>	<ul style="list-style-type: none"> <li>Last.fm radio is not available in all countries. Please check <a href="http://www.last.fm/hardware">www.last.fm/hardware</a> for more information.</li> </ul>	–
Cannot login to Last.fm. ("Incorrect user or password" is displayed.)	<ul style="list-style-type: none"> <li>Incorrect username or password entered for login authentication.</li> </ul>	<ul style="list-style-type: none"> <li>Enter the correct username and password and retry login.</li> </ul>	–
Cannot create and register an account. ("Try another username" is displayed.)	<ul style="list-style-type: none"> <li>The username has already been taken.</li> </ul>	<ul style="list-style-type: none"> <li>Enter another username to create and register the account.</li> </ul>	–

### [AirPlay]

Symptom	Cause	Countermeasure	Page
The AirPlay icon  is not displayed in iTunes or on the iPhone/iPod touch.	<ul style="list-style-type: none"> <li>This unit and the computer or iPhone/iPod touch are not connected to the same network (LAN).</li> <li>iTunes or the iPhone/iPod touch do not have firmware that supports AirPlay installed.</li> </ul>	<ul style="list-style-type: none"> <li>Connect the computer or iPhone/iPod touch to the same network as this unit.</li> <li>Update to the latest firmware.</li> </ul>	<a href="#">8</a>  <a href="#">12</a>
No sound.	<ul style="list-style-type: none"> <li>This unit is not selected in the screen that is displayed when iTunes or the iPhone/iPod touch is started.</li> </ul>	<ul style="list-style-type: none"> <li>Start iTunes or switch on the iPhone/iPod touch, click the AirPlay icon  in the displayed screen, and select this unit.</li> </ul>	<a href="#">34</a>
When using AirPlay with the iPhone/iPod touch/iPad, the sound suffers from intermittent breaks or AirPlay does not function.	<ul style="list-style-type: none"> <li>Some applications are running in the background on iPhone/iPod touch/iPad.</li> </ul>	<ul style="list-style-type: none"> <li>Quit the application running in the background of the iPhone/iPod touch/iPad, and then play using AirPlay.</li> </ul>	–
	<ul style="list-style-type: none"> <li>When playing via a wireless connection, outside conditions may affect the unit.</li> </ul>	<ul style="list-style-type: none"> <li>To remedy this, change the network environment, e.g. shorten the distance to the wireless LAN access point.</li> </ul>	–
	<ul style="list-style-type: none"> <li>The iPhone/iPod touch/iPad application or iTunes is not the latest version.</li> </ul>	<ul style="list-style-type: none"> <li>Update the iPhone/iPod touch/iPad application or iTunes to the latest version.</li> </ul>	–

### [Remote control unit]

Symptom	Cause	Countermeasure	Page
Set does not work properly when remote control operated.	<ul style="list-style-type: none"> <li>Batteries are worn.</li> <li>You are operating outside of the specified range.</li> <li>Obstacle between main unit and remote control.</li> </ul>	<ul style="list-style-type: none"> <li>Replace with new batteries.</li> <li>Operate within the specified range.</li> <li>Remove the obstacle.</li> </ul>	<a href="#">4</a> <a href="#">4</a> –
	<ul style="list-style-type: none"> <li>The batteries are not inserted in the proper direction, as indicated by the polarity marks in the battery compartment.</li> <li>The set's remote control sensor is exposed to strong light (direct sunlight, fluorescent light, etc.).</li> </ul>	<ul style="list-style-type: none"> <li>Insert the batteries in the proper direction, following the polarity marks in the battery compartment.</li> <li>Move the set to a place in which the remote control sensor will not be exposed to strong light.</li> </ul>	<a href="#">4</a> <a href="#">4</a>



## Resetting the microprocessor

Perform this procedure if the display is abnormal or if operations cannot be performed. When the microprocessor is reset, all the settings are reset to their default values and all previously stored custom settings will have to be manually restored.

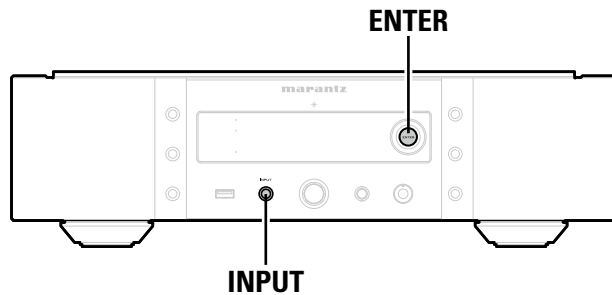

- 1 Pull the power cord out of the power outlet.**
- 2 Plug the power cord into a power outlet while pressing ENTER and INPUT on the main unit.**
- 3 When the STANDBY indicator lights, release the buttons.**  
"Initialized" appears in the display.



If "Initialized" does not display in step 3, start over from step 1.

## Specifications

### ❑ Audio performance

#### • Analog output

**Channels:**

2 channels

**Playable frequency range:**

2 Hz – 96 kHz

**Playable frequency response:**

2 Hz – 50 kHz (–3 dB) (DSD mode,  
PCM sampling frequency: 192 kHz)  
2 Hz – 20 kHz  
(PCM sampling frequency: 44.1 kHz)

**S/N:**

110 dB (Audible Range)

**Dynamic Range:**

110 dB (Audible Range)

**Harmonic Distortion:**

0.001 % (1 kHz, Audible Range)

#### • Output Level

**Unbalanced:**

2.3 V RMS Stereo

**Balanced:**

4.6 V RMS Stereo

**Headphone output:**

30 mW/32 Ω/ohms (variable maximum)

#### • Digital output

**Coaxial:**

0.5 Vp-p

**Optical:**

–19 dBm

#### • Digital input

**Coaxial:**

0.5 Vp-p

**Optical:**

–27 dBm or later

**USB (Front)**

USB Type A (USB 2.0 High speed)

**USB (Rear)**

USB Type B (USB 2.0 High speed)

### ❑ Power supply

**Power supply voltage/frequency:**

AC 230 V, 50/60 Hz

**Power consumption:**

50 W

**Power consumption in standby mode:**

0.4 W

**Power consumption in**

**"Network Control" – "On" mode:**

3 W

- For purposes of improvement, specifications and design are subject to change without notice.

## Index

- A**
  - Accessories ..... 1
  - AirPlay ..... 34, 48
  - ALAC ..... 45, 46, 48
  - App Store ..... 4, 34, 48
  - Audio
    - DC Filter ..... 18
    - Digital Out ..... 18
    - Noise Shaper ..... 18
    - Phase ..... 19
  - Auto-Standby ..... 12
- B**
  - Bit rate ..... 45, 47, 48
- C**
  - Cable
    - Audio cable ..... 6
    - Balanced audio cable ..... 6
    - Coaxial digital cable ..... 6, 7
    - LAN cable ..... 6, 8
    - iPod cable ..... 6, 30
    - Monaural mini-plug cable ..... 6, 9
    - Optical cable ..... 6, 7
    - Remote connector cable ..... 6, 9
    - USB cable ..... 6, 7
  - Characters ..... 26, 40, 41
  - Charging the iPod ..... 31
  - Condensation ..... 3
  - Connection
    - Analog (BALANCED) ..... 6
    - Analog (UNBALANCED) ..... 6
    - Digital ..... 7
    - FLASHER IN ..... 9
    - Home network (LAN) ..... 8
    - PC ..... 7
    - Power cord ..... 10
    - Remote control jacks ..... 9
    - RS-232C ..... 9
- D**
  - D/A converter ..... 7, 39
  - DC Filter ..... 18
  - Digital Out ..... 18
  - Direct mode ..... 30
  - Disconnecting the iPod ..... 31
  - Display's brightness ..... 22
  - DLNA ..... 48
  - DSD ..... 39, 48
- E**
  - EXTERNAL ..... 9
- F**
  - Favorite list ..... 29
  - Filter characteristics ..... 22
  - Firmware
    - Add New Feature ..... 14
    - Notification ..... 13
    - Update ..... 12
  - FLAC ..... 45, 46, 48
  - Friendly Name ..... 17
  - Front panel ..... 43
- G**
  - Gateway ..... 15
  - General
    - Auto-Standby ..... 12
    - Firmware ..... 12
    - Language ..... 12
- H**
  - Headphones ..... 22, 43
- I**
  - Inputting characters ..... 40, 41
  - INTERNAL ..... 9
  - Internet radio ..... 23, 46
  - IP Address ..... 15
  - iTunes ..... 34, 36, 48
- L**
  - Language ..... 12
  - Last.fm ..... 26, 47
  - Last.fm Display ..... 17
- M**
  - Menu map ..... 11
  - Menu operation ..... 11
  - MP3 ..... 45, 46, 48
  - MPEG ..... 48
  - MPEG-4 AAC ..... 45, 46, 48
  - Music server ..... 25, 46
- N**
  - Network ..... 15
    - DHCP ..... 15
    - Friendly Name ..... 17
    - Last.fm Display ..... 17
    - Network Control ..... 17
    - Proxy ..... 16
  - Noise Shaper ..... 18
- P**
  - Phase ..... 19
  - Playback
    - ALAC ..... 45, 46
    - FLAC ..... 45, 46
    - Internet radio ..... 23
  - iPod ..... 30
  - Last.fm ..... 26
  - MP3 ..... 45, 46
  - MPEG-4 AAC ..... 45, 46
  - Music server ..... 25
  - NAS ..... 25
  - Network audio ..... 23
  - PC ..... 25
  - Random ..... 25, 28, 30, 32, 33
  - Remote play ..... 36
  - Repeat ..... 25, 28, 30, 32, 33
  - Spotify ..... 27
  - USB memory device ..... 32, 45
  - WAV ..... 45, 46
  - WMA ..... 45, 46
  - Primary DNS ..... 15
  - Proxy ..... 16
- Q**
  - Quick Setup ..... 12
- R**
  - Rear panel ..... 43
  - Remote control ..... 3, 44
    - Battery ..... 3
  - Remote mode ..... 30
  - Resetting the microprocessor ..... 54
- S**
  - Sampling frequency ..... 45, 47, 48
  - Secondary DNS ..... 15
  - Selecting the input source ..... 21
  - Sleep timer ..... 22
  - Spotify ..... 27, 47
  - Subnet Mask ..... 15
  - Supported iPod models ..... 31
- T**
  - Turning the power on ..... 21
- U**
  - Update on web screen ..... 13
- V**
  - vTuner ..... 46, 48
- W**
  - WAV ..... 45, 46
  - Web control ..... 37
  - Windows Media DRM ..... 46, 48
  - Windows Media Player ..... 24, 49
  - WMA ..... 45, 46, 49

## License

**This section describes software license used for this unit. To maintain the correct content, the original (English) is used.**

### Boost

<http://www.boost.org/>

Boost Software License - Version 1.0 - August 17th, 2003

Permission is hereby granted, free of charge, to any person or organization obtaining a copy of the software and accompanying documentation covered by this license (the "Software") to use, reproduce, display, distribute, execute, and transmit the Software, and to prepare derivative works of the Software, and to permit third-parties to whom the Software is furnished to do so, all subject to the following:

The copyright notices in the Software and this entire statement, including the above license grant, this restriction and the following disclaimer, must be included in all copies of the Software, in whole or in part, and all derivative works of the Software, unless such copies or derivative works are solely in the form of machine-executable object code generated by a source language processor.

THE SOFTWARE IS PROVIDED "AS IS", WITHOUT WARRANTY OF ANY KIND, EXPRESS OR IMPLIED, INCLUDING BUT NOT LIMITED TO THE WARRANTIES OF MERCHANTABILITY, FITNESS FOR A PARTICULAR PURPOSE, TITLE AND NON-INFRINGEMENT. IN NO EVENT SHALL THE COPYRIGHT HOLDERS OR ANYONE DISTRIBUTING THE SOFTWARE BE LIABLE FOR ANY DAMAGES OR OTHER LIABILITY, WHETHER IN CONTRACT, TORT OR OTHERWISE, ARISING FROM, OUT OF OR IN CONNECTION WITH THE SOFTWARE OR THE USE OR OTHER DEALINGS IN THE SOFTWARE.

### Expat

<http://www.jclark.com/xml/expat.html>

Expat License. Copyright (c) 1998, 1999, 2000 Thai Open Source Software Center Ltd

Permission is hereby granted, free of charge, to any person obtaining a copy of this software and associated documentation files (the "Software"), to deal in the Software without restriction, including without limitation the rights to use, copy, modify, merge, publish, distribute, sublicense, and/or sell copies of the Software, and to permit persons to whom the Software is furnished to do so, subject to the following conditions:

The above copyright notice and this permission notice shall be included in all copies or substantial portions of the Software.

THE SOFTWARE IS PROVIDED "AS IS", WITHOUT WARRANTY OF ANY KIND, EXPRESS OR IMPLIED, INCLUDING BUT NOT LIMITED TO THE WARRANTIES OF MERCHANTABILITY, FITNESS FOR A PARTICULAR PURPOSE AND NON-INFRINGEMENT. IN NO EVENT SHALL THE AUTHORS OR COPYRIGHT HOLDERS BE LIABLE FOR ANY CLAIM, DAMAGES OR OTHER LIABILITY, WHETHER IN AN ACTION OF CONTRACT, TORT OR OTHERWISE, ARISING FROM, OUT OF OR IN

CONNECTION WITH THE SOFTWARE OR THE USE OR OTHER DEALINGS IN THE SOFTWARE.

### FastDelegate

<http://www.codeproject.com/KB/cpp/FastDelegate.aspx>

THE WORK (AS DEFINED BELOW) IS PROVIDED UNDER THE TERMS OF THIS CODE PROJECT OPEN LICENSE ("LICENSE"). THE WORK IS PROTECTED BY COPYRIGHT AND/OR OTHER APPLICABLE LAW. ANY USE OF THE WORK OTHER THAN AS AUTHORIZED UNDER THIS LICENSE OR COPYRIGHT LAW IS PROHIBITED.

BY EXERCISING ANY RIGHTS TO THE WORK PROVIDED HEREIN, YOU ACCEPT AND AGREE TO BE BOUND BY THE TERMS OF THIS LICENSE. THE AUTHOR GRANTS YOU THE RIGHTS CONTAINED HEREIN IN CONSIDERATION OF YOUR ACCEPTANCE OF SUCH TERMS AND CONDITIONS. IF YOU DO NOT AGREE TO ACCEPT AND BE BOUND BY THE TERMS OF THIS LICENSE, YOU CANNOT MAKE ANY USE OF THE WORK.

#### 1. Definitions.

- a. "Articles" means, collectively, all articles written by Author which describes how the Source Code and Executable Files for the Work may be used by a user.
- b. "Author" means the individual or entity that offers the Work under the terms of this License.
- c. "Derivative Work" means a work based upon the Work or upon the Work and other pre-existing works.
- d. "Executable Files" refer to the executables, binary files, configuration and any required data files included in the Work.
- e. "Publisher" means the provider of the website, magazine, CD-ROM, DVD or other medium from or by which the Work is obtained by You.
- f. "Source Code" refers to the collection of source code and configuration files used to create the Executable Files.
- g. "Standard Version" refers to such a Work if it has not been modified, or has been modified in accordance with the consent of the Author, such consent being in the full discretion of the Author.
- h. "Work" refers to the collection of files distributed by the Publisher, including the Source Code, Executable Files, binaries, data files, documentation, whitepapers and the Articles.

- i. "You" is you, an individual or entity wishing to use the Work and exercise your rights under this License.
2. Fair Use/Fair Use Rights. Nothing in this License is intended to reduce, limit, or restrict any rights arising from fair use, fair dealing, first sale or other limitations on the exclusive rights of the copyright owner under copyright law or other applicable laws.

3. License Grant. Subject to the terms and conditions of this License, the Author hereby grants You a worldwide, royalty-free, non-exclusive, perpetual (for the duration of the applicable copyright) license to exercise the rights in the Work as stated below:

- a. You may use the standard version of the Source Code or Executable Files in Your own applications.
- b. You may apply bug fixes, portability fixes and other modifications obtained from the Public Domain or from the Author. A Work modified in such a way shall still be considered the standard version and will be subject to this License.

c. You may otherwise modify Your copy of this Work (excluding the Articles) in any way to create a Derivative Work, provided that You insert a prominent notice in each changed file stating how, when and where You changed that file.

d. You may distribute the standard version of the Executable Files and Source Code or Derivative Work in aggregate with other (possibly commercial) programs as part of a larger (possibly commercial) software distribution.

e. The Articles discussing the Work published in any form by the author may not be distributed or republished without the Author's consent. The author retains copyright to any such Articles. You may use the Executable Files and Source Code pursuant to this License but you may not repost or republish or otherwise distribute or make available the Articles, without the prior written consent of the Author.

Any subroutines or modules supplied by You and linked into the Source Code or Executable Files this Work shall not be considered part of this Work and will not be subject to the terms of this License.

4. Patent License. Subject to the terms and conditions of this License, each Author hereby grants to You a perpetual, worldwide, non-exclusive, no-charge, royalty-free, irrevocable (except as stated in this section) patent license to make, have made, use, import, and otherwise transfer the Work.

5. Restrictions. The license granted in Section 3 above is expressly made subject to and limited by the following restrictions:

- a. You agree not to remove any of the original copyright, patent, trademark, and attribution notices and associated disclaimers that may appear in the Source Code or Executable Files.
- b. You agree not to advertise or in any way imply that this Work is a product of Your own.
- c. The name of the Author may not be used to endorse or promote products derived from the Work without the prior written consent of the Author.
- d. You agree not to sell, lease, or rent any part of the Work. This does not restrict you from including the Work or any part of the Work inside a larger software distribution that itself is being sold. The Work by itself, though, cannot be sold, leased or rented.
- e. You may distribute the Executable Files and Source Code only under the terms of this License, and You must include a copy of, or the Uniform Resource Identifier for, this License with every copy of the Executable Files or Source Code You distribute and ensure that anyone receiving such Executable Files and Source Code agrees that the terms of this License apply to such Executable Files and/or Source Code. You may not offer or impose any terms on the Work that alter or restrict the terms of this License or the recipients' exercise of the rights granted hereunder. You may not sublicense the Work. You must keep intact all notices that refer to this License and to the disclaimer of warranties. You may not distribute the Executable Files or Source Code with any technological measures that control access or use of the Work in a manner inconsistent with the terms of this License.
- f. You agree not to use the Work for illegal, immoral or improper purposes, or on pages containing illegal, immoral or improper material. The Work is subject to

applicable export laws. You agree to comply with all such laws and regulations that may apply to the Work after Your receipt of the Work.

6. Representations, Warranties and Disclaimer. THIS WORK IS PROVIDED "AS IS", "WHERE IS" AND "AS AVAILABLE", WITHOUT ANY EXPRESS OR IMPLIED WARRANTIES OR CONDITIONS OR GUARANTEES. YOU, THE USER, ASSUME ALL RISK IN ITS USE, INCLUDING COPYRIGHT INFRINGEMENT, PATENT INFRINGEMENT, SUITABILITY, ETC. AUTHOR EXPRESSLY DISCLAIMS ALL EXPRESS, IMPLIED OR STATUTORY WARRANTIES OR CONDITIONS, INCLUDING WITHOUT LIMITATION, WARRANTIES OR CONDITIONS OF MERCHANTABILITY, MERCHANTABLE QUALITY OR FITNESS FOR A PARTICULAR PURPOSE, OR ANY WARRANTY OF TITLE OR NON-INFRINGEMENT, OR THAT THE WORK (OR ANY PORTION THEREOF) IS CORRECT, USEFUL, BUG-FREE OR FREE OF VIRUSES. YOU MUST PASS THIS DISCLAIMER ON WHENEVER YOU DISTRIBUTE THE WORK OR DERIVATIVE WORKS.

7. Indemnity. You agree to defend, indemnify and hold harmless the Author and the Publisher from and against any claims, suits, losses, damages, liabilities, costs, and expenses (including reasonable legal or attorneys' fees) resulting from or relating to any use of the Work by You.

8. Limitation on Liability. EXCEPT TO THE EXTENT REQUIRED BY APPLICABLE LAW, IN NO EVENT WILL THE AUTHOR OR THE PUBLISHER BE LIABLE TO YOU ON ANY LEGAL THEORY FOR ANY SPECIAL, INCIDENTAL, CONSEQUENTIAL, PUNITIVE OR EXEMPLARY DAMAGES ARISING OUT OF THIS LICENSE OR THE USE OF THE WORK OR OTHERWISE, EVEN IF THE AUTHOR OR THE PUBLISHER HAS BEEN ADVISED OF THE POSSIBILITY OF SUCH DAMAGES.

9. Termination.

a. This License and the rights granted hereunder will terminate automatically upon any breach by You of any term of this License. Individuals or entities who have received Derivative Works from You under this License, however, will not have their licenses terminated provided such individuals or entities remain in full compliance with those licenses. Sections 1, 2, 6, 7, 8, 9, 10 and 11 will survive any termination of this License.

b. If You bring a copyright, trademark, patent or any other infringement claim against any contributor over infringements You claim are made by the Work, your License from such contributor to the Work ends automatically.

c. Subject to the above terms and conditions, this License is perpetual (for the duration of the applicable copyright in the Work). Notwithstanding the above, the Author reserves the right to release the Work under different license terms or to stop distributing the Work at any time; provided, however that any such election will not serve to withdraw this License (or any other license that has been, or is required to be, granted under the terms of this License), and this License will continue in full force and effect unless terminated as stated above.

10. Publisher. The parties hereby confirm that the Publisher shall not, under any circumstances, be responsible for and shall not have any liability in respect of the subject matter of this License. The Publisher makes no warranty

whatsoever in connection with the Work and shall not be liable to You or any party on any legal theory for any damages whatsoever, including without limitation any general, special, incidental or consequential damages arising in connection to this license. The Publisher reserves the right to cease making the Work available to You at any time without notice

#### 11. Miscellaneous

- a. This License shall be governed by the laws of the location of the head office of the Author or if the Author is an individual, the laws of location of the principal place of residence of the Author.
- b. If any provision of this License is invalid or unenforceable under applicable law, it shall not affect the validity or enforceability of the remainder of the terms of this License, and without further action by the parties to this License, such provision shall be reformed to the minimum extent necessary to make such provision valid and enforceable.
- c. No term or provision of this License shall be deemed waived and no breach consented to unless such waiver or consent shall be in writing and signed by the party to be charged with such waiver or consent.
- d. This License constitutes the entire agreement between the parties with respect to the Work licensed herein. There are no understandings, agreements or representations with respect to the Work not specified herein. The Author shall not be bound by any additional provisions that may appear in any communication from You. This License may not be modified without the mutual written agreement of the Author and You

#### □ libogg

<http://www.xiph.org/ogg/>

Copyright (c) 2002, Xiph.org Foundation

Redistribution and use in source and binary forms, with or without modification, are permitted provided that the following conditions are met:

- Redistributions of source code must retain the above copyright notice, this list of conditions and the following disclaimer.
- Redistributions in binary form must reproduce the above copyright notice, this list of conditions and the following disclaimer in the documentation and/or other materials provided with the distribution.
- Neither the name of the Xiph.org Foundation nor the names of its contributors may be used to endorse or promote products derived from this software without specific prior written permission.

THIS SOFTWARE IS PROVIDED BY THE COPYRIGHT HOLDERS AND CONTRIBUTORS "AS IS" AND ANY EXPRESS OR IMPLIED WARRANTIES, INCLUDING, BUT NOT LIMITED TO, THE IMPLIED WARRANTIES OF MERCHANTABILITY AND FITNESS FOR A PARTICULAR PURPOSE ARE DISCLAIMED. IN NO EVENT SHALL THE FOUNDATION OR CONTRIBUTORS BE LIABLE FOR ANY DIRECT, INDIRECT, INCIDENTAL, SPECIAL, EXEMPLARY, OR CONSEQUENTIAL DAMAGES (INCLUDING, BUT NOT LIMITED TO, PROCUREMENT OF SUBSTITUTE GOODS OR SERVICES; LOSS OF USE, DATA, OR PROFITS; OR BUSINESS INTERRUPTION) HOWEVER CAUSED AND ON

ANY THEORY OF LIABILITY, WHETHER IN CONTRACT, STRICT LIABILITY, OR TORT (INCLUDING NEGLIGENCE OR OTHERWISE) ARISING IN ANY WAY OUT OF THE USE OF THIS SOFTWARE, EVEN IF ADVISED OF THE POSSIBILITY OF SUCH DAMAGE.

#### □ libvorbis

<http://www.xiph.org/vorbis/>

Copyright (c) 2002-2004 Xiph.org Foundation

Redistribution and use in source and binary forms, with or without modification, are permitted provided that the following conditions are met:

- Redistributions of source code must retain the above copyright notice, this list of conditions and the following disclaimer.
- Redistributions in binary form must reproduce the above copyright notice, this list of conditions and the following disclaimer in the documentation and/or other materials provided with the distribution.
- Neither the name of the Xiph.org Foundation nor the names of its contributors may be used to endorse or promote products derived from this software without specific prior written permission.

THIS SOFTWARE IS PROVIDED BY THE COPYRIGHT HOLDERS AND CONTRIBUTORS "AS IS" AND ANY EXPRESS OR IMPLIED WARRANTIES, INCLUDING, BUT NOT LIMITED TO, THE IMPLIED WARRANTIES OF MERCHANTABILITY AND FITNESS FOR A PARTICULAR PURPOSE ARE DISCLAIMED. IN NO EVENT SHALL THE FOUNDATION OR CONTRIBUTORS BE LIABLE FOR ANY DIRECT, INDIRECT, INCIDENTAL, SPECIAL, EXEMPLARY, OR CONSEQUENTIAL DAMAGES (INCLUDING, BUT NOT LIMITED TO, PROCUREMENT OF SUBSTITUTE GOODS OR SERVICES; LOSS OF USE, DATA, OR PROFITS; OR BUSINESS INTERRUPTION) HOWEVER CAUSED AND ON ANY THEORY OF LIABILITY, WHETHER IN CONTRACT, STRICT LIABILITY, OR TORT (INCLUDING NEGLIGENCE OR OTHERWISE) ARISING IN ANY WAY OUT OF THE USE OF THIS SOFTWARE, EVEN IF ADVISED OF THE POSSIBILITY OF SUCH DAMAGE.

#### □ Tremolo

<http://wvss.co.uk/pinknoise/tremolo>

Copyright (C) 2002-2009 Xiph.org Foundation Changes Copyright (C) 2009-2010 Robin Watts for Pinknoise Productions Ltd

Redistribution and use in source and binary forms, with or without modification, are permitted provided that the following conditions are met:

- Redistributions of source code must retain the above copyright notice, this list of conditions and the following disclaimer.
- Redistributions in binary form must reproduce the above copyright notice, this list of conditions and the following disclaimer in the documentation and/or other materials provided with the distribution.

- Neither the name of the Xiph.org Foundation nor the names of its contributors may be used to endorse or promote products derived from this software without specific prior written permission.

THIS SOFTWARE IS PROVIDED BY THE COPYRIGHT HOLDERS AND CONTRIBUTORS "AS IS" AND ANY EXPRESS OR IMPLIED WARRANTIES, INCLUDING, BUT NOT LIMITED TO, THE IMPLIED WARRANTIES OF MERCHANTABILITY AND FITNESS FOR A PARTICULAR PURPOSE ARE DISCLAIMED. IN NO EVENT SHALL THE FOUNDATION OR CONTRIBUTORS BE LIABLE FOR ANY DIRECT, INDIRECT, INCIDENTAL, SPECIAL, EXEMPLARY, OR CONSEQUENTIAL DAMAGES (INCLUDING, BUT NOT LIMITED TO, PROCUREMENT OF SUBSTITUTE GOODS OR SERVICES; LOSS OF USE, DATA, OR PROFITS; OR BUSINESS INTERRUPTION) HOWEVER CAUSED AND ON ANY THEORY OF LIABILITY, WHETHER IN CONTRACT, STRICT LIABILITY, OR TORT (INCLUDING NEGLIGENCE OR OTHERWISE) ARISING IN ANY WAY OUT OF THE USE OF THIS SOFTWARE, EVEN IF ADVISED OF THE POSSIBILITY OF SUCH DAMAGE.

#### □ Tremor

<http://wiki.xiph.org/index.php/Tremor>

Copyright (c) 2002, Xiph.org Foundation

Redistribution and use in source and binary forms, with or without modification, are permitted provided that the following conditions are met:

- Redistributions of source code must retain the above copyright notice, this list of conditions and the following disclaimer.
- Redistributions in binary form must reproduce the above copyright notice, this list of conditions and the following disclaimer in the documentation and/or other materials provided with the distribution.
- Neither the name of the Xiph.org Foundation nor the names of its contributors may be used to endorse or promote products derived from this software without specific prior written permission.

THIS SOFTWARE IS PROVIDED BY THE COPYRIGHT HOLDERS AND CONTRIBUTORS "AS IS" AND ANY EXPRESS OR IMPLIED WARRANTIES, INCLUDING, BUT NOT LIMITED TO, THE IMPLIED WARRANTIES OF MERCHANTABILITY AND FITNESS FOR A PARTICULAR PURPOSE ARE DISCLAIMED. IN NO EVENT SHALL THE FOUNDATION OR CONTRIBUTORS BE LIABLE FOR ANY DIRECT, INDIRECT, INCIDENTAL, SPECIAL, EXEMPLARY, OR CONSEQUENTIAL DAMAGES (INCLUDING, BUT NOT LIMITED TO, PROCUREMENT OF SUBSTITUTE GOODS OR SERVICES; LOSS OF USE, DATA, OR PROFITS; OR BUSINESS INTERRUPTION) HOWEVER CAUSED AND ON ANY THEORY OF LIABILITY, WHETHER IN CONTRACT, STRICT LIABILITY, OR TORT (INCLUDING NEGLIGENCE OR OTHERWISE) ARISING IN ANY WAY OUT OF THE USE OF THIS SOFTWARE, EVEN IF ADVISED OF THE POSSIBILITY OF SUCH DAMAGE.

#### □ Mersenne Twister

<http://www.math.sci.hiroshima-u.ac.jp/~m-mat/MT/MT2002/CODES/mt19937ar.c>

Copyright (C) 1997 - 2002, Makoto Matsumoto and Takuji Nishimura,  
All rights reserved.

Redistribution and use in source and binary forms, with or without modification, are permitted provided that the following conditions are met:

1. Redistributions of source code must retain the above copyright notice, this list of conditions and the following disclaimer.
2. Redistributions in binary form must reproduce the above copyright notice, this list of conditions and the following disclaimer in the documentation and/or other materials provided with the distribution.
3. The names of its contributors may not be used to endorse or promote products derived from this software without specific prior written permission.

THIS SOFTWARE IS PROVIDED BY THE COPYRIGHT HOLDERS AND CONTRIBUTORS "AS IS" AND ANY EXPRESS OR IMPLIED WARRANTIES, INCLUDING, BUT NOT LIMITED TO, THE IMPLIED WARRANTIES OF MERCHANTABILITY AND FITNESS FOR A PARTICULAR PURPOSE ARE DISCLAIMED. IN NO EVENT SHALL THE COPYRIGHT OWNER OR CONTRIBUTORS BE LIABLE FOR ANY DIRECT, INDIRECT, INCIDENTAL, SPECIAL, EXEMPLARY, OR CONSEQUENTIAL DAMAGES (INCLUDING, BUT NOT LIMITED TO, PROCUREMENT OF SUBSTITUTE GOODS OR SERVICES; LOSS OF USE, DATA, OR PROFITS; OR BUSINESS INTERRUPTION) HOWEVER CAUSED AND ON ANY THEORY OF LIABILITY, WHETHER IN CONTRACT, STRICT LIABILITY, OR TORT (INCLUDING NEGLIGENCE OR OTHERWISE) ARISING IN ANY WAY OUT OF THE USE OF THIS SOFTWARE, EVEN IF ADVISED OF THE POSSIBILITY OF SUCH DAMAGE.

#### □ zlib

<http://www.zlib.net/>

zlib.h – interface of the 'zlib' general purpose compression library version 1.2.3, July 18th, 2005

Copyright (C) 1995-2004 Jean-loup Gailly and Mark Adler

This software is provided 'as-is', without any express or implied warranty. In no event will the authors be held liable for any damages arising from the use of this software.

Permission is granted to anyone to use this software for any purpose, including commercial applications, and to alter it and redistribute it freely, subject to the following restrictions:

1. The origin of this software must not be misrepresented; you must not claim that you wrote the original software. If you use this software in a product, an acknowledgment in the product documentation would be appreciated but is not required.
2. Altered source versions must be plainly marked as such, and must not be misrepresented as being the original software.
3. This notice may not be removed or altered from any source distribution.

Jean-loup Gailly [jloup@gzip.org](mailto:jloup@gzip.org), Mark Adler [madler@alumni.caltech.edu](mailto:madler@alumni.caltech.edu)

## **cURL**

<http://curl.haxx.se>

### COPYRIGHT AND PERMISSION NOTICE

Copyright (c) 1996 - 2011, Daniel Stenberg, <[daniel@haxx.se](mailto:daniel@haxx.se)>.

All rights reserved.

Permission to use, copy, modify, and distribute this software for any purpose with or without fee is hereby granted, provided that the above copyright notice and this permission notice appear in all copies.

THE SOFTWARE IS PROVIDED "AS IS", WITHOUT WARRANTY OF ANY KIND, EXPRESS OR IMPLIED, INCLUDING BUT NOT LIMITED TO THE WARRANTIES OF MERCHANTABILITY, FITNESS FOR A PARTICULAR PURPOSE AND NONINFRINGEMENT OF THIRD PARTY RIGHTS. IN NO EVENT SHALL THE AUTHORS OR COPYRIGHT HOLDERS BE LIABLE FOR ANY CLAIM, DAMAGES OR OTHER LIABILITY, WHETHER IN AN ACTION OF CONTRACT, TORT OR OTHERWISE, ARISING FROM, OUT OF OR IN CONNECTION WITH THE SOFTWARE OR THE USE OR OTHER DEALINGS IN THE SOFTWARE.

Except as contained in this notice, the name of a copyright holder shall not be used in advertising or otherwise to promote the sale, use or other dealings in this Software without prior written authorization of the copyright holder.

## **c-ares**

<http://c-ares.haxx.se>

Copyright 1998 by the Massachusetts Institute of Technology.

Permission to use, copy, modify, and distribute this software and its documentation for any purpose and without fee is hereby granted, provided that the above copyright notice appear in all copies and that both that copyright notice and this permission notice appear in supporting documentation, and that the name of M.I.T. not be used in advertising or publicity pertaining to distribution of the software without specific, written prior permission. M.I.T. makes no representations about the suitability of this software for any purpose. It is provided "as is" without express or implied warranty.

## **License Information for the Software Used in the Unit**

### **About GPL (GNU-General Public License), LGPL (GNU Lesser General Public License) License**

This product uses GPL/LGPL software and software made by other companies.

After you purchase this product, you may procure, modify or distribute the source code of the GPL/LGPL software that is used in the product.

Marantz provides the source code based on the GPL and LPGL licenses at the actual cost upon your request to our customer service center. However, note that we make no guarantees concerning the source code. Please also understand that we do not offer support for the contents of the source code.

# Dimensions

Unit : mm

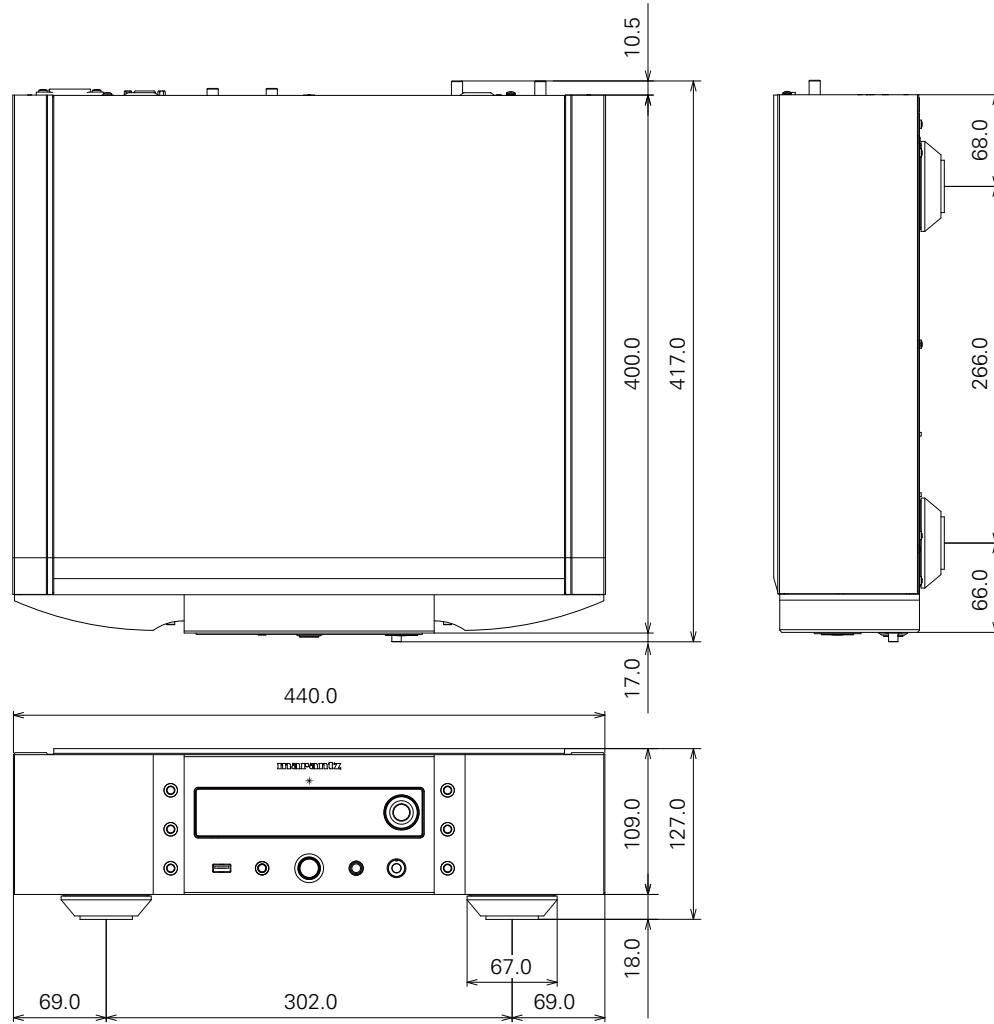

Weight : 14.6 kg

**[www.marantz.com](http://www.marantz.com)**

You can find your nearest authorized distributor or dealer on our website.

**marantz**<sup>®</sup> is a registered trademark.