



marantz®

Integrated Amplifier **HD-AMP1**

You can print more than one page of a PDF onto a single sheet of paper.

Owner's Manual

[Front panel](#)[Display](#)[Rear panel](#)[Remote](#)[Index](#)

Accessories	5
About the remote control	6
Inserting the batteries	6
Operating range of the remote control unit	6
Main features	7
High quality sound	7
High performance	8
Easy operation	8
Part names and functions	9
Front panel	9
Display	11
Rear panel	12
Remote control unit	13

Connections

Connecting speakers	17
Speaker connection	19
Connecting an audio playback device	20
Connecting a PC or Mac	21
Connecting an iPod or USB memory device to the USB port	22
Connecting devices with remote control connectors	24
Performing operations by RC on this unit without visual contact	24
Remotely connecting Marantz audio devices	24
Connecting the power cord	25



Playback

Basic operation	27
Turning the power on	27
Selecting the input source	28
Adjusting the volume	28
Turning off the sound temporarily (Muting)	28
Switching the display's brightness	29
Using as a D/A converter	30
Connecting and playing back from a computer (USB-DAC)	31
Connect and playback from a digital device (COAX/OPT1/OPT2)	40
Playing back an iPod	41
Playing an iPod	42
Setting operation mode (On-Display mode)	43
Performing repeat playback	44
Performing random playback	44
Charging the iPod	44
Playing a USB memory device	45
Playing files stored on USB memory devices	46
Performing repeat playback	48
Performing random playback	48
Playing audio from devices connected to the ANALOG connector	49

Settings

Menu map	50
Menu operation	51
S. Direct	52
Bass	52
Treble	52
Balance	52
Filter	53
H/P Gain	53
Dimmer	54
iPodMode	54
AutoStby	54



Tips

Contents	55
Tips	56
Troubleshooting	57

Appendix

Playing back a USB memory devices	65
Playback order of files	66
About folders and files	67
How to handle media	67
D/A converter	68
Explanation of terms	69
Trademark information	71
Specifications	72
Index	75







Thank you for purchasing this Marantz product.

To ensure proper operation, please read this owner's manual carefully before using the product.

After reading this manual, be sure to keep it for future reference.

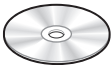
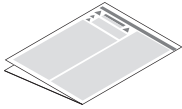
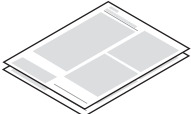
Accessories

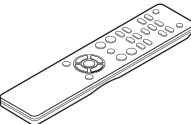
Check that the following parts are supplied with the product.

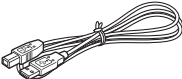
 Quick Start Guide	 CD-ROM (Owner's Manual)	 Safety Instructions	 Warranty (for USA/for CANADA)	 Power cord
 Remote control unit	 R03/AAA batteries	 USB cable		



About the remote control

Inserting the batteries

- 1 Remove the rear lid in the direction of the arrow and remove it.

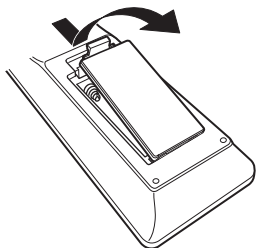

- 2 Insert two batteries correctly into the battery compartment as indicated.

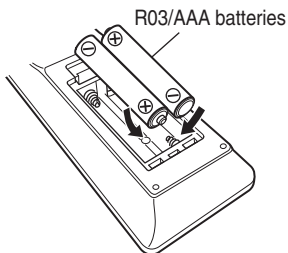

- 3 Put the rear cover back on.

NOTE

- To prevent damage or leakage of battery fluid:
 - Do not use a new battery together with an old one.
 - Do not use two different types of batteries.
- If the battery fluid should leak, carefully wipe the fluid off the inside of the battery compartment and insert new batteries.

Operating range of the remote control unit

Point the remote control unit at the remote sensor when operating it.

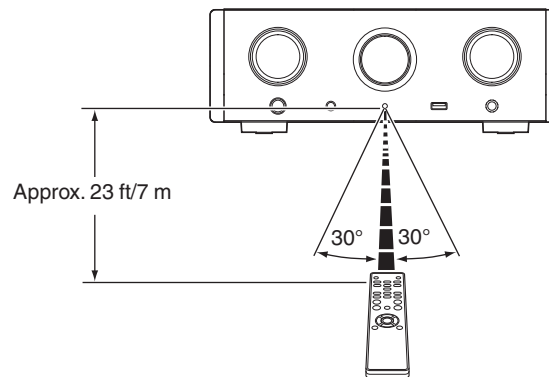

Main features

High quality sound

- **Large-capacitance block capacitor**

A large capacitance 3,300 μF capacitor carefully selected for its acoustic characteristics is incorporated into the power supply circuit.

- **Audiophile-grade film capacitors and electrolytic capacitors**

The unit's features the same audiophile-grade film capacitors and electrolytic capacitors specifically used in top-range models.

- **Low noise amp due differential input HDAM, and equipped with a low distortion filter circuit due to high speed HDAM[®]SA2 delivery amp**

- **Double-layered chassis**

- **Marantz unique filtering technology (MMDF: Marantz Musical Digital Filtering)**

This unit is equipped with oversampling and digital filter functions using an original algorithm created by Marantz. The unit supports PCM and analog input signals. Toggle between the two types to suit your preferences.

- **High grade headphone circuit**

This unit has a two-amplifier structure based on the design concept of luxury models, comprising a current feedback voltage amplifier using the HDAM[®]SA2 and a feedbackless Darlington power buffer. This allows higher speeds without creating dynamic strain in response to impedance changes in the headphones.

- **Isolation design**

To prevent audio quality from degrading due to noise from external devices when this unit is connected to external devices such as computers, the ground circuit for the USB input interface device is isolated from the audio circuit.



High performance

- **Equipped with a USB-DAC function to support playback of high-resolution sound sources**

This unit supports the playback of high resolution audio formats such as DSD (2.8/5.6/11.2 MHz) and PCM files up to 384 kHz/32 bits. It provides high quality playback of high resolution files into this unit from a computer via USB-B connection.

- **DIGITAL AUDIO IN connectors (COAXIAL/OPTICAL)**

You can play back PCM signals up to 192 kHz/24 bits by inputting digital audio signals from an external device into this unit.

- **Plays USB memory devices (MP3/WMA/AAC/WAV/FLAC/ALAC/AIFF/DSD) and iPod®/iPhone®**

You can play back audio files stored on a USB memory device or iPod/iPhone by connecting the USB memory device or iPod/iPhone to the USB port.

Easy operation

- **iPod® auto detect charges your device even after the unit switches to standby mode (🔌 p. 22)**
- **Equipped with auto standby mode function that reduces power consumption**



Part names and functions

For buttons not explained here, see the page indicated in parentheses ().

Front panel

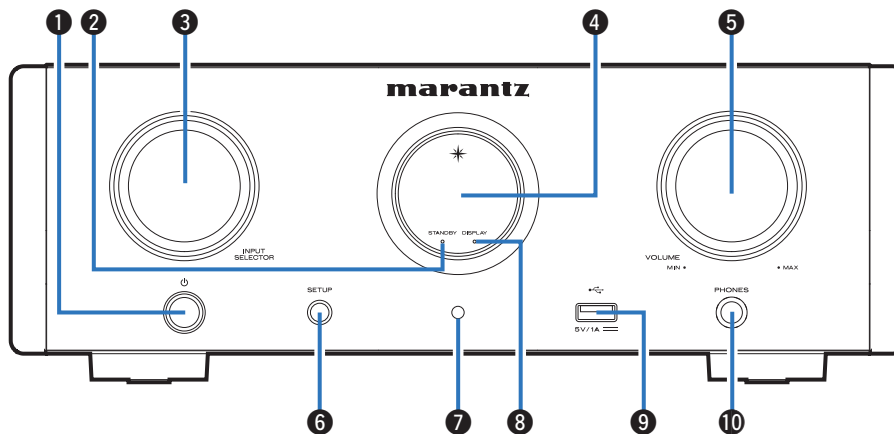

❶ Power operation button (⏻)

This turns the power on/off (standby). (📖 p. 27)

❷ Standby indicator (STANDBY)

The standby indicator changes as shown below according to the status of the unit.

- Power on : Off
- Normal standby : Red
- iPod charge standby : Orange

❸ Input source select knob (INPUT SELECTOR)

These select the input source. (📖 p. 28)

❹ Display

Information such as the playback status and input source is displayed here.

❺ VOLUME knob

This adjusts the volume level.



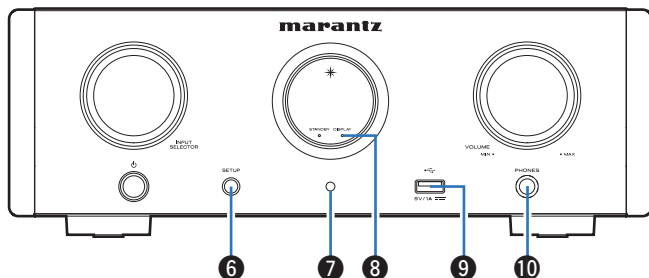

6 SETUP button

Used to set up this unit.

7 Remote control sensor

This receives signals from the remote control unit. (☞ p. 6)

8 Display off indicator (DISPLAY)

This indicator lights up when the display is off. (☞ p. 29)

9 USB port (☞)

Used to connect iPod or USB memory devices. (☞ p. 22)

10 Headphones jack (PHONES)

Used to connect headphones.

- When the headphones are plugged into this jack, audio will no longer be output from the speaker terminals, SUBWOOFER OUT connector.
- “S.Direct” is set to “On” when headphones are connected. (☞ p. 52)

NOTE

- To prevent hearing loss, do not raise the volume level excessively when using headphones.



Display

The input source name, sampling frequency, setting values and other information are displayed here.

■ D/A converter display

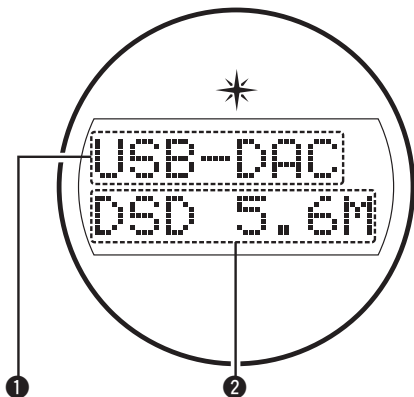

① Input source indicator

This indicator displays the selected input source (USB-DAC/COAX/OPT1/OPT2).

② Sampling frequency display

This indicator displays the sampling frequency of the input audio signal.

■ iPod/USB playback indicator

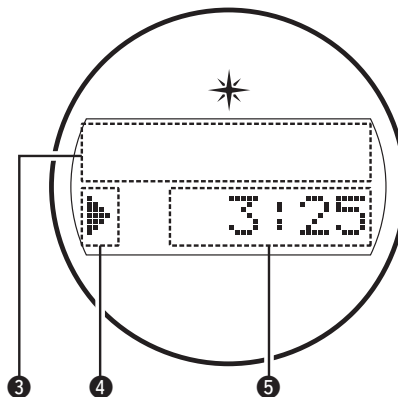

③ Information display

This indicator displays the track information, etc.

④ Playback mode indicators

▶: Displayed during playback.

■: Displayed during pause.

⑤ Time indicator

This indicator displays the elapsed time of the current track.



Rear panel

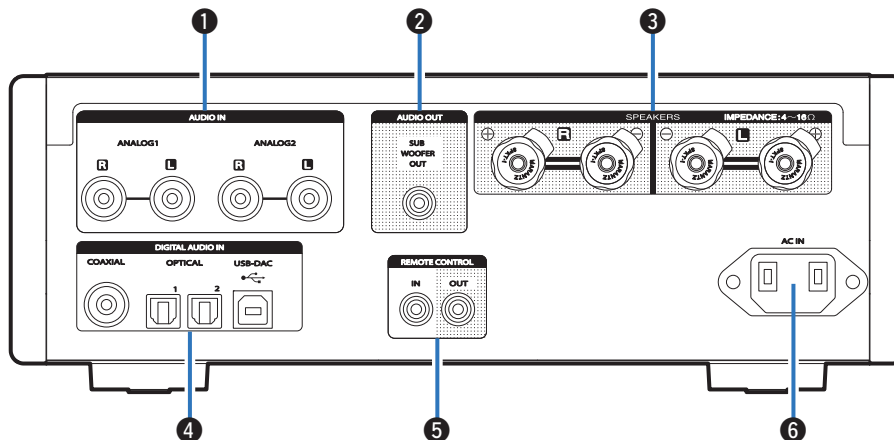

1 AUDIO IN connectors

Used to connect devices equipped with analog audio connectors. (☞ p. 20)

2 SUBWOOFER OUT connector

Used to connect a subwoofer with a built-in amplifier. (☞ p. 19)

3 Speaker terminals (SPEAKERS)

Used to connect speakers. (☞ p. 19)

4 DIGITAL AUDIO IN connectors

Used to connect a computer or devices equipped with digital audio output connectors. (☞ p. 20)

5 Remote control input/output connectors (REMOTE CONTROL IN/OUT)

Used to connect to a Marantz audio device that is compatible with the remote control function. (☞ p. 24)

6 AC inlet (AC IN)

Used to connect the power cord. (☞ p. 25)



Remote control unit

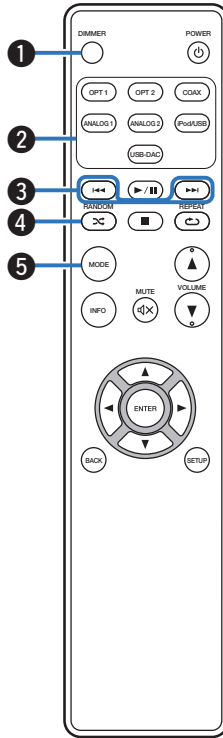

1 DIMMER button

Adjust the display brightness of this unit. (☞ p. 29)

2 Input source select buttons

These select the input source. (☞ p. 28)

3 Skip buttons (⏮, ⏭)

This skips to the start of the track. Press and hold to fast-forward/fast reverse.

- “Setting operation mode (On-Display mode)” (☞ p. 43)
- “Playing files stored on USB memory devices” (☞ p. 47)

4 RANDOM button (🎲)

Switches the random playback.

- iPod: “Performing random playback” (☞ p. 44)
- USB: “Performing random playback” (☞ p. 48)

5 MODE button

This switches the playback mode.

- “Setting operation mode (On-Display mode)” (☞ p. 43)
- “Playing files stored on USB memory devices” (☞ p. 47)



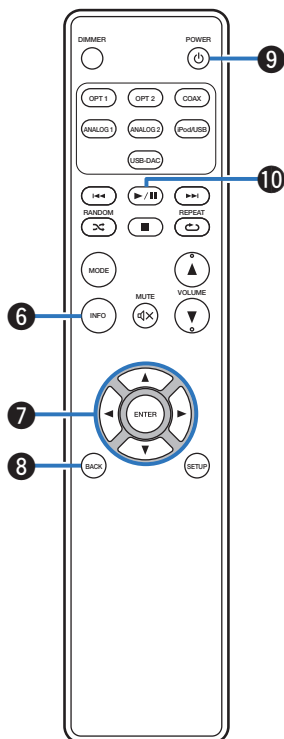

6 Information button (INFO)

This switches display items such as the album name and title name in the playback screen.

- “Setting operation mode (On-Display mode)” (☞ p. 43)
- “Playing files stored on USB memory devices” (☞ p. 47)

7 Cursor buttons ($\Delta \nabla \triangleleft \triangleright$)

These select items.

- “Setting operation mode (On-Display mode)” (☞ p. 43)
- “Playing files stored on USB memory devices” (☞ p. 47)
- “Menu operation” (☞ p. 51)

8 BACK button

Returns to the previous item. (☞ p. 51)

9 POWER button (ϕ)

This turns the power on/off (standby). (☞ p. 27)

10 Play/pause button ($\blacktriangleright / \text{II}$)

Plays back or pauses a track.

- “Setting operation mode (On-Display mode)” (☞ p. 43)
- “Playing files stored on USB memory devices” (☞ p. 47)



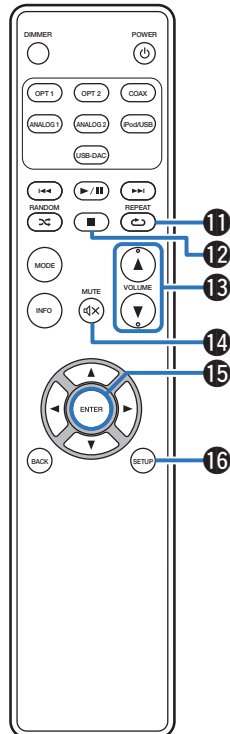

11 REPEAT button (↺)

Switches the repeat playback.

- iPod: "Performing repeat playback" (🔗 p. 44)
- USB: "Performing repeat playback" (🔗 p. 48)

12 Stop button (■)

Stops playback.

- "Setting operation mode (On-Display mode)" (🔗 p. 43)
- "Playing files stored on USB memory devices" (🔗 p. 47)

13 VOLUME buttons (▲▼)

These adjust the volume level. (🔗 p. 28)

14 MUTE button (🔇)

This mutes the output audio. (🔗 p. 28)

15 ENTER button

This determines the selection. (🔗 p. 51)

16 SETUP button

The setting menu is displayed on the display. (🔗 p. 51)



■ Contents







Connecting speakers	17
Connecting an audio playback device	20
Connecting a PC or Mac	21
Connecting an iPod or USB memory device to the USB port	22
Connecting devices with remote control connectors	24
Connecting the power cord	25

NOTE

- Do not plug in the power cord until all connections have been completed.
- Do not bundle power cords with connection cables. Doing so can result in humming or noise.

■ Cables used for connections

Provide necessary cables according to the devices you want to connect.

Speaker cable	
Audio cable	
Remote connector cable	
Optical cable	
Coaxial digital cable	
USB cable (supplied)	



Connecting speakers

NOTE

- Disconnect this unit's power plug from the power outlet before connecting the speakers.
- Connect so that the speaker cable core wires do not protrude from the speaker terminal. The protection circuit may be activated if the core wires touch the rear panel or if the + and - sides touch each other.
- Never touch the speaker terminals while the power cord is connected. Doing so could result in electric shock.
- Use speakers with impedance of 4 - 16 Ω /ohms.

■ Connecting the speaker cables

Carefully check the left (L) and right (R) channels and + (red) and - (white) polarities on the speakers being connected to this unit, and be sure to connect the channels and polarities correctly.

- 1 Peel off about 3/8 inch (10 mm) of sheathing from the tip of the speaker cable, then either twist the core wire tightly or terminate it.**



- 2 Turn the speaker terminal counterclockwise to loosen it.**

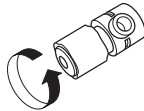

- 3 Insert the speaker cable's core wire to all the way into the speaker terminal.**



- Wire gauge: less than ϕ 1/4 inch (ϕ 5 mm)

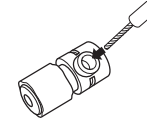

- 4 Turn the speaker terminal clockwise to tighten it.**

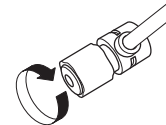

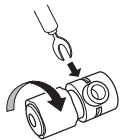
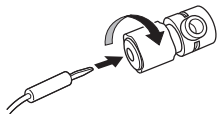
Spade lug connector**Banana plug****NOTE**

- When using banana plugs, rotate the terminals clockwise to tighten them before inserting the banana plugs.



Speaker connection

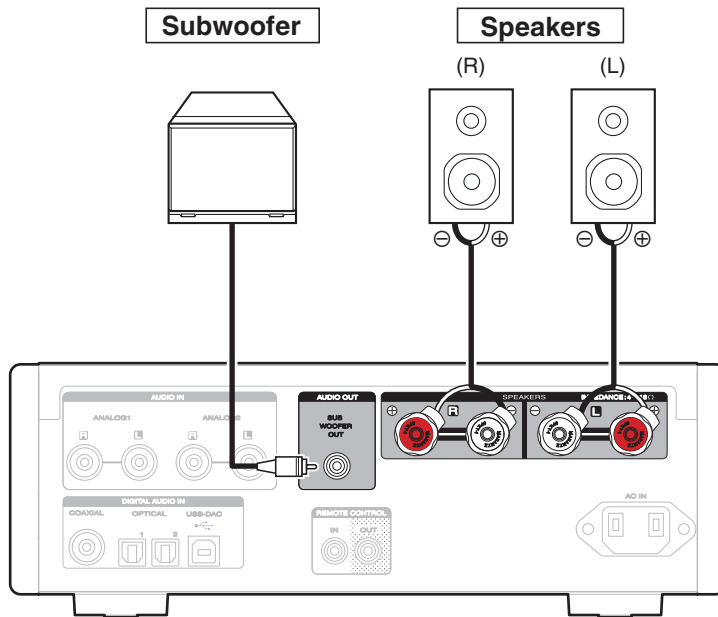

Connecting an audio playback device

Connect the AUDIO IN or DIGITAL AUDIO IN to an audio playback device (CD player, Digital device, etc...) using the appropriate cables.

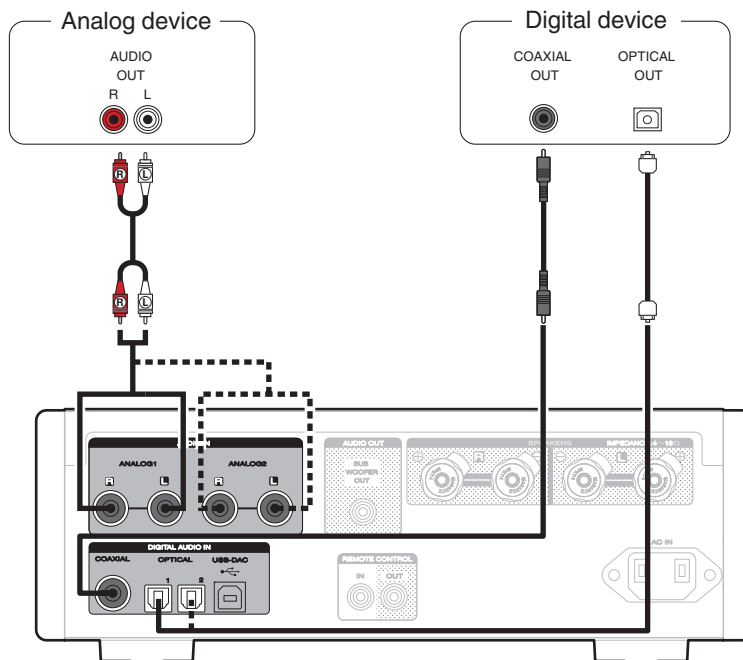

Connecting a PC or Mac

By connecting a computer to the USB port (USB-DAC) on the rear panel of this unit using a commercially available USB cable (supplied), this unit can be used as a D/A converter. (🔗 p. 31)

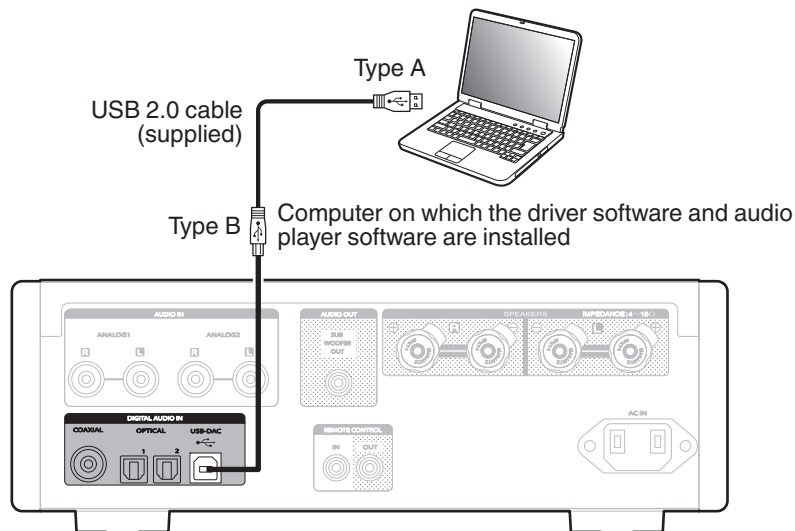

- Before USB connecting this unit to your computer, install the driver software in your computer. (🔗 p. 31)
- Download the driver software from the HD-AMP1 page of the Marantz website.

NOTE

- Use a cable that is 10 ft (3 m) or less to connect to the computer.



Connecting an iPod or USB memory device to the USB port

You can enjoy music stored on an iPod/iPhone or USB memory device.

- To connect an iPod/iPhone to this unit, use the USB adapter cable that was supplied with the iPod/iPhone.
- For operating instructions see “Playing an iPod” (🔗 p. 42) or “Playing files stored on USB memory devices” (🔗 p. 46).

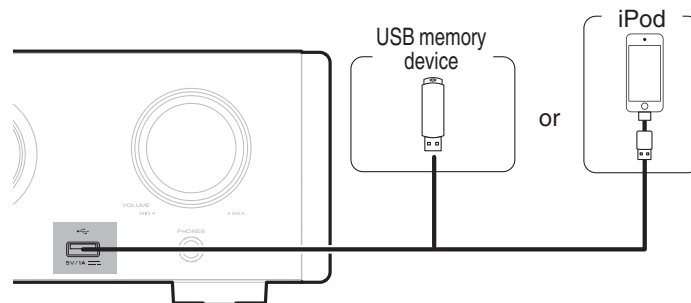

- Marantz does not guarantee that all USB memory devices will operate or receive power. When using a portable USB hard disk drive (HDD) which came with an AC adapter, use that device's supplied AC adapter.

NOTE

- USB memory devices will not work via a USB hub.
- Playback is not possible when connected to a PC via the front panel's USB port. Connection to a PC is possible via the digital input USB-DAC port (Type B) on the rear panel.
- Do not use an extension cable when connecting a USB memory device. This may cause radio interference with other devices.



■ Supported iPod/iPhone models

• iPod classic



iPod classic
80GB



iPod classic
160GB (2007)



iPod classic
160GB (2009)

• iPod nano



iPod nano
3rd generation
(video)
4GB 8GB



iPod nano
4th generation (video)
8GB 16GB



iPod nano
5th generation (video camera)
8GB 16GB



iPod nano
6th generation
8GB 16GB



iPod nano
7th generation
16GB

• iPod touch



iPod touch
4th generation
8GB 16GB 32GB 64GB



iPod touch
5th generation
16GB 32GB 64GB

• iPhone



iPhone 3GS
8GB 16GB 32GB



iPhone 4
8GB 16GB 32GB



iPhone 4S
16GB 32GB 64GB



iPhone 5
iPhone 5c iPhone 5s
16GB 32GB 64GB



iPhone 6
16GB 64GB 128GB



iPhone 6 Plus
16GB 64GB 128GB



Connecting devices with remote control connectors

Performing operations by RC on this unit without visual contact

You can connect an external IR receiver to the REMOTE CONTROL connectors to perform operations on this unit with the supplied remote control unit without visual contact. This might be necessary if the unit is hidden in a cupboard or corner, so you can't directly point with the remote control unit to the device.

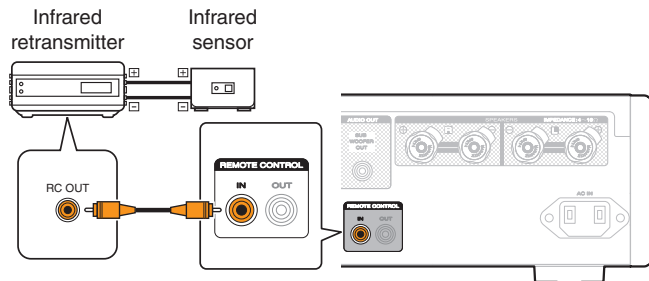

Remotely connecting Marantz audio devices

You can transmit remote control signals simply by connecting a Marantz audio device to the REMOTE CONTROL IN/OUT connectors using the remote connection cable provided with the device.

Set the remote control switch located on the rear panel of the connected audio component to "EXTERNAL" to use this feature.

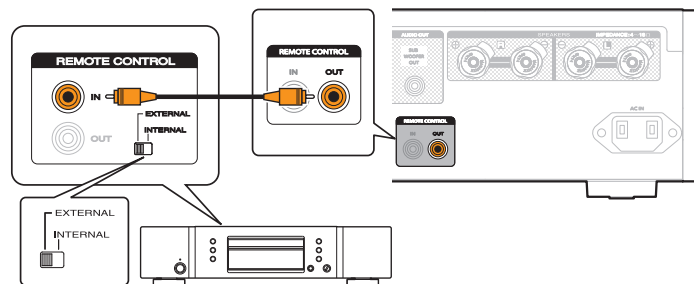

Connecting the power cord

Wait until all connections have been completed before connecting the power cord.

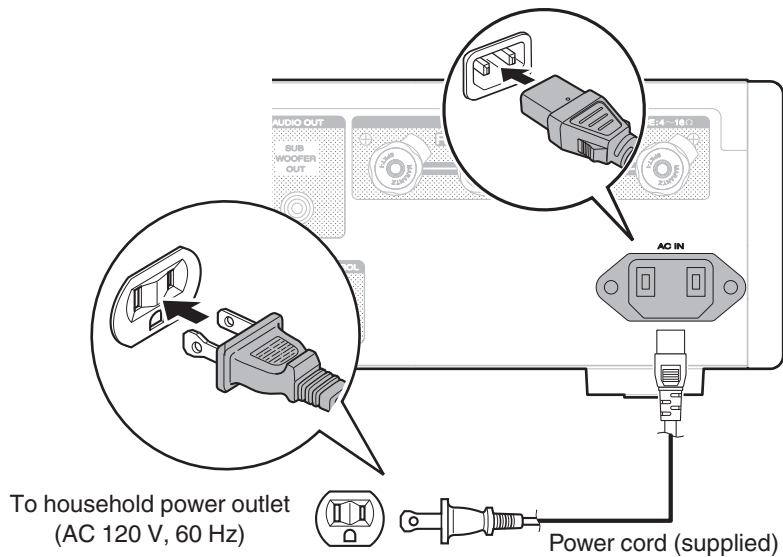

■ Contents

Turning the power on	27	Using as a D/A converter	30
Selecting the input source	28	Playing back an iPod	41
Adjusting the volume	28	Playing a USB memory device	45
Turning off the sound temporarily (Muting)	28	Playing audio from devices connected to the ANALOG connector	49
Switching the display's brightness	29		



Basic operation

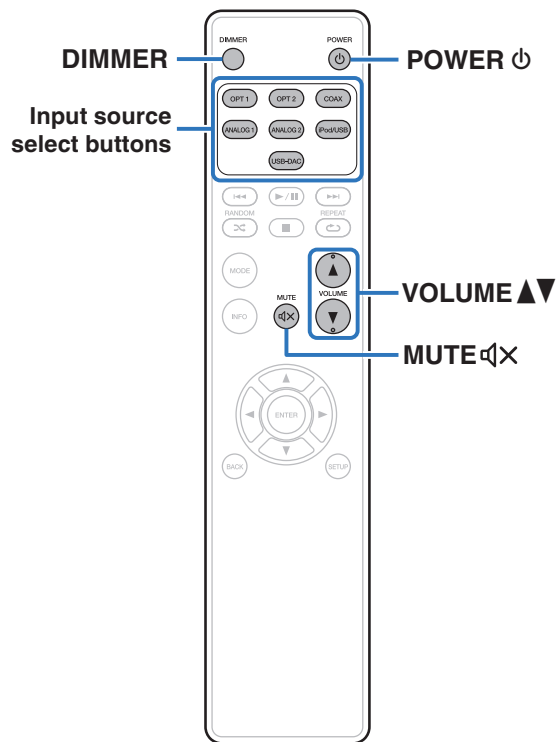

Turning the power on

- 1 Press **POWER** to turn on power to the unit.
The power indicator turns off.

Switching the power to standby

- 1 Press **POWER** .
- The unit switches to standby mode.



- You can also switch the power to standby by pressing on the main unit.

NOTE

- Power continues to be supplied to some of the circuitry even when the power is in the standby mode. When leaving home for long periods of time or when going on vacation, unplug the power cord from the power outlet.



Selecting the input source

1 Press the input source select button to be played back.

USB-DAC:	Plays back audio files on the computer.
COAX:	Plays back the device connected to the COAXIAL connector.
OPT1:	Plays back the device connected to the OPTICAL 1 connector.
OPT2:	Plays back the device connected to the OPTICAL 2 connector.
iPod/USB:	Plays back an iPod or USB memory device.
ANALOG 1:	Plays back analog audio signals input to the ANALOG1 connector.
ANALOG 2:	Plays back analog audio signals input to the ANALOG2 connector.



- You can also select the input source by turning INPUT SELECTOR on the main unit.

Adjusting the volume

1 Press VOLUME ▲▼ to adjust the volume.



- You can also adjust the master volume by turning VOLUME on the main unit.

Turning off the sound temporarily (Muting)

1 Press MUTE .

“MUTE ON” appears in the display.



- To cancel mute, press MUTE  again.



Switching the display's brightness

The display brightness can be adjusted between four levels. Switching the display off reduces a source of noise that affects sound quality, enabling higher sound quality playback.

1 Press DIMMER.



- When the display is turned off, the display off indicator lights up.
- The brightness of the display can also be switched in the setting menu on the display of the main unit.

NOTE

- During stop mode, the display information does not turn off. The information is turned off only during playback.



Using as a D/A converter

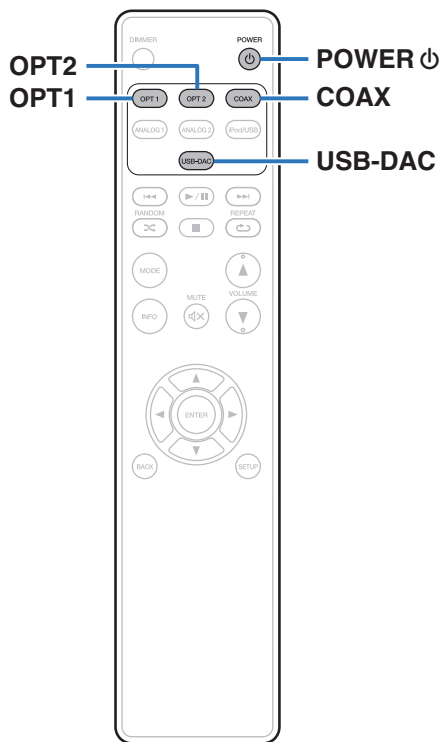

Digital audio signals input from an external device or computer into this unit can be converted and output as analog signals using this unit's D/A converter. (D/A converter function)

- DSD is a registered trademark.
- Microsoft, Windows 7 and Windows 8 are either registered trademarks or trademarks of Microsoft Corporation in the United States and/or other countries.
- ASIO is a trademark of Steinberg Media Technologies GmbH.
- Apple, Macintosh and Mac OS are trademarks of Apple Inc., registered in the U.S. and other countries.



Connecting and playing back from a computer (USB-DAC)

You can enjoy high-quality audio playback from the D/A converter built in to this unit by inputting music files into this unit from a computer via USB connection.

- Before USB connecting this unit to your computer, install the driver software in your computer.
- Drivers do not need to be installed for Mac OS.
- Also, you can use whichever commercially available or downloadable player software you like to playback files on your computer.

■ Computer (recommended system)

OS

- Windows® Windows 7 or Windows 8/8.1
- Mac OS X 10.10.1

USB

- USB 2.0: USB High speed/USB Audio Class Ver.2.0

NOTE

- This unit was checked the operation using the recommended system by us, but it does not guarantee the operation of all systems.

Windows OS Installing the dedicated driver (🔗 p. 31)

Mac OS Audio Device Settings (🔗 p. 38)

■ Installing the dedicated driver (Windows OS only)

□ Installing the driver software

- 1 Disconnect the USB cable between your PC and the unit.**
 - The driver software cannot be installed correctly if your PC is connected to the unit by a USB cable.
 - If the unit and your computer are connected by a USB cable and the computer is switched on before installation, disconnect the USB and restart the computer.
- 2 Download the dedicated driver from the “Download” section of the HD-AMP1 page of the Marantz website onto your PC.**
- 3 Unzip the downloaded file, and double-click the exe file.**



4 Install the driver.

- 1 Select the language to use for the installation.
- 2 Click "OK".

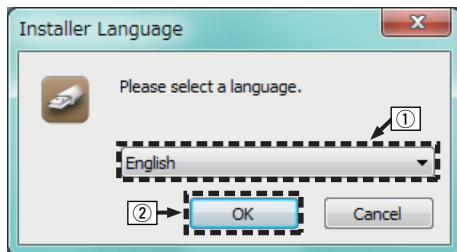

- 3 The wizard menu is displayed. Click "Next".

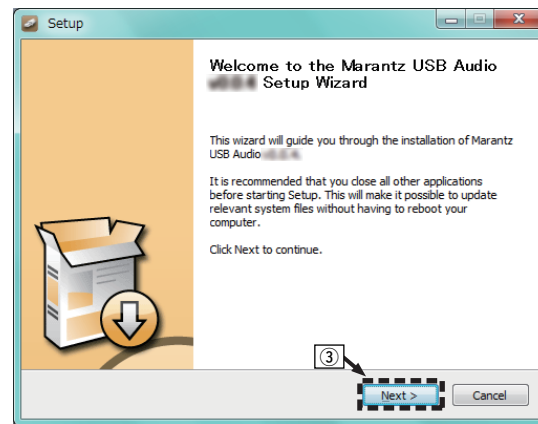

- ④ Read the Software Licensing Agreement, and click “I accept the terms of the License Agreement”.
- ⑤ Click “Next”.

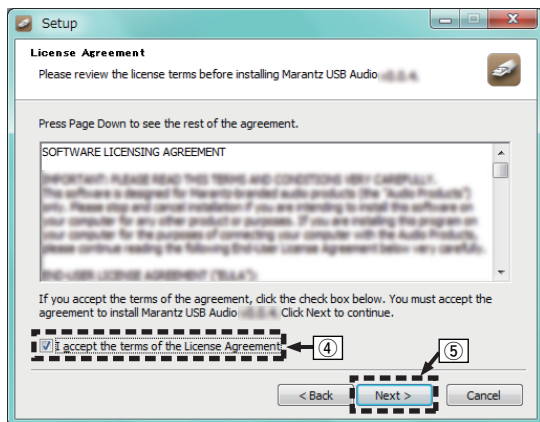

- ⑥ Click “Install” on the installation start dialog.
 - The installation starts. Do not perform any operation on the PC until the installation is completed.

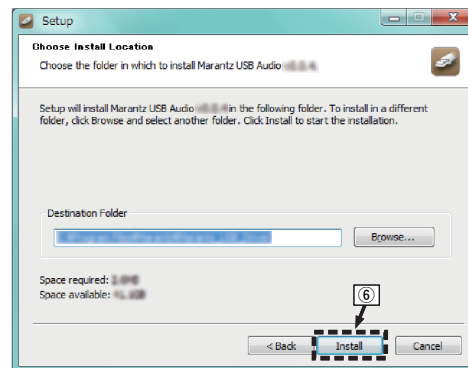

⑦ Click “Next”.

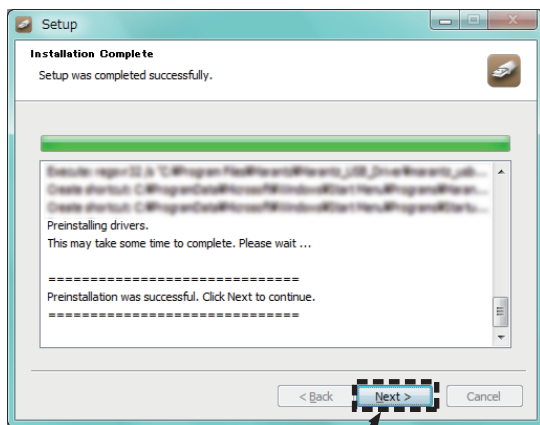

⑧ When the installation is completed, click “Finish”.

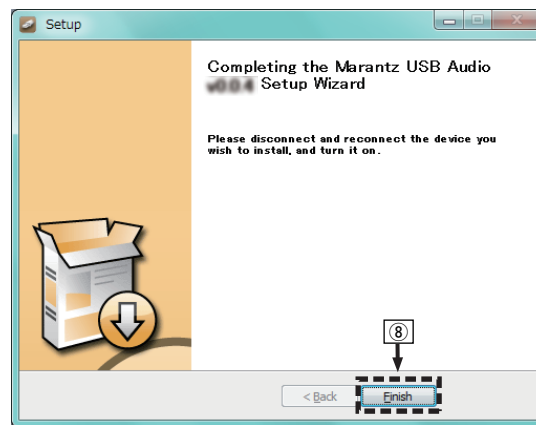

⑨ Click “Yes”.

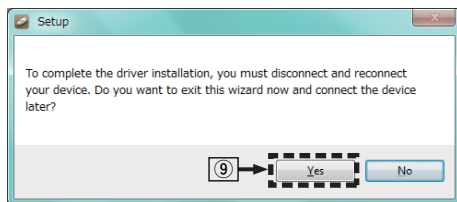

5 With the unit power off, connect the unit and PC using a USB cable (supplied).

- For the connection procedure, refer to the “Connecting a PC or Mac” section. (☞ p. 21)

6 Press POWER ϕ .

- When the unit power is turned on, the PC automatically finds and connects to the unit.

7 Press the input source select button (USB-DAC) to switch the input source to “USB-DAC”.

8 Checking the installed driver.

- ① Click the “Start” button and click “Control Panel” on the PC.
 - The control panel setting list is displayed.
- ② Click the “Sound” icon.
 - The sound menu window is displayed.
- ③ Check that there is a checkmark next to “Default Device” under in “HD-AMP1” of the “Playback” tab.
 - When there is a checkmark for a different device, click HD-AMP1 and “Set Default”.



9 Checking audio output.

Outputs a TEST signal from the PC and checks the audio output from the USB-DAC function.

- ① Select “HD-AMP1” and click “Properties”.
 - The HD-AMP1 Properties window is displayed.

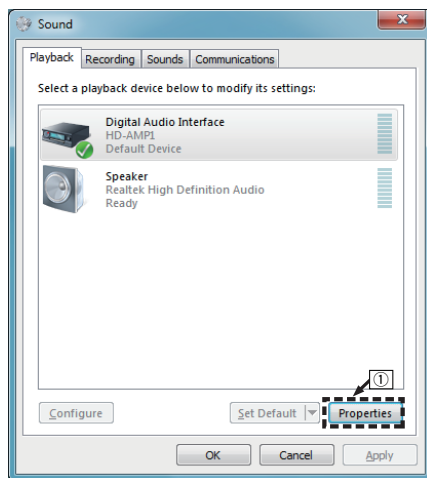

- ② Click the “Advanced” tab.
- ③ Select the sampling rate and bit rate to be applied to the D/A converter.
 - It is recommended that “2 channel, 24 bit, 192000 Hz (Studio Quality)” is selected (Windows 7).
 - It is recommended that “2 channel, 32 bit, 192000 Hz (Studio Quality)” is selected (Windows 8/8.1).
- ④ Click “Apply”.
- ⑤ Click “Test”.
 - Check that audio from this unit is output from the PC.

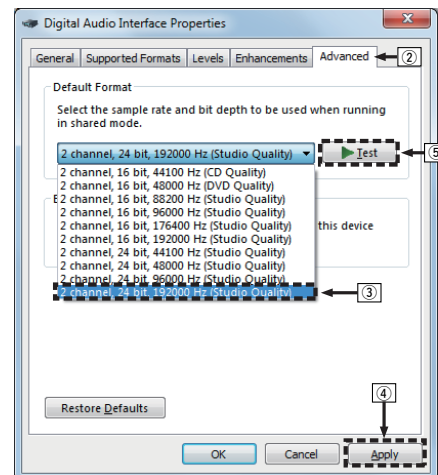

NOTE

- The dedicated driver must be installed in the PC before this unit is connected to a PC. Operation will not occur correctly if connected to the PC before the dedicated driver has been installed.
- Player software supporting the Audio Stream Input Output (ASIO) driver is required to play files with a sampling frequency of 352.8 kHz/384 kHz without downsampling. Check your player software before playing files with the ASIO driver.
- Operation may fail in some PC hardware and software configurations.
- Please see the FAQ at www.marantz.com if you experience any issues getting audio to play from your computer through the this unit. You may also want to check the support pages for your audio player application.



■ Audio Device Settings (Mac OS X only)

- ① Move the cursor to “Go” on the computer screen, and then click “Utilities”.
 - The utility list is displayed.
- ② Double-click “Audio MIDI Setup”.
 - The “Audio Devices” window is displayed.
- ③ Check that “Use this device for sound output” is checked in “HD-AMP1”.
 - If a different device is checked, select and “Secondary click” on “HD-AMP1”, and then select “Use this device for sound output”.

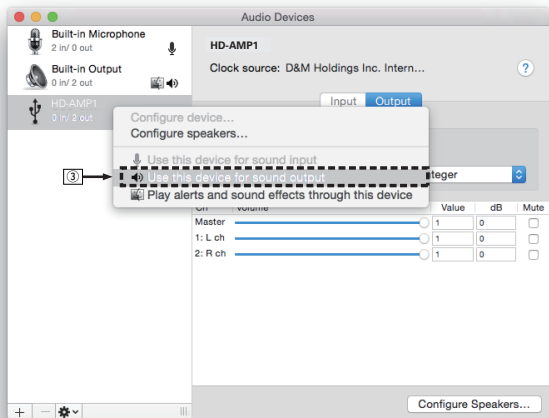

- ④ Select the “HD-AMP1” format.
 - It is normally recommended to set the format to “384000.0 Hz” and “2ch-32 bit Interger”.

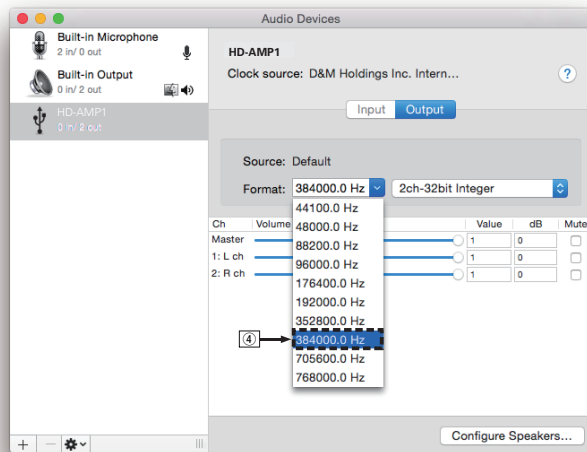

- ⑤ Quit Audio MIDI Setup.



■ Playback

Install the desired player software on your computer beforehand.
Use the rear panel USB-DAC port to connect this unit to a computer.
( p. 21)

1 Press USB-DAC to switch the input source to “USB-DAC”.

Start playback on the computer’s player software.

The digital audio signal that is being input is shown as follows in the display.

“USB-DAC
xxxxk” or “USB-DAC
DSD xxxM”

(xxxx is the sampling frequency.)

- If the sampling frequency cannot be detected, “Unlocked” will be displayed.
- “Unsupported” is displayed when audio signals that are not supported by this unit are input.

■ Audio signals that can be played back

See “D/A converter” ( p. 68).

NOTE

- Perform operations such as playback and pause on the computer. At this time, you cannot perform operations with buttons on this unit or the remote control.
- When this unit is functioning as a D/A converter, sound is not output from the computer’s speakers.
- If the computer is disconnected from this unit while the computer music playback software is running, the playback software may freeze. Always exit the playback software before disconnecting the computer.
- When an error occurs on the computer, disconnect the USB cable and restart the computer.
- The sampling frequency of the music playback software and sampling frequency displayed on this unit may differ.
- Use a cable that is 10 ft (3 m) or less to connect to the computer.



Connect and playback from a digital device (COAX/OPT1/OPT2)

1 Press COAX, OPT1 or OPT2 to switch the input source to “COAX”, “OPT1” or “OPT2”.

The digital audio signal that is being input is shown as follows in the display.

“COAX
xxxxk” or “OPT1
xxxxk” or “OPT2
xxxxk”

(xxxx is the sampling frequency.)

- If the sampling frequency cannot be detected, “Unlocked” will be displayed.
- “Unsupported” is displayed when audio signals that are not supported by this unit are input.

■ Specifications of supported audio formats

See “D/A converter” ( p. 68).

NOTE

- Do not input non-PCM signals, such as Dolby Digital, and DTS. This causes noise and could damage the speakers.
- If the sampling frequency switches, such as from A mode to B mode in a CS broadcast, muting may operate for 1 – 2 seconds, cutting the sound.



Playing back an iPod

- You can use the USB cable provided with the iPod to connect the iPod with the unit's USB port and enjoy music stored on the iPod.
- For information on the iPod models that can be played back with this unit, see "Supported iPod/iPhone models" (📖 p. 23).

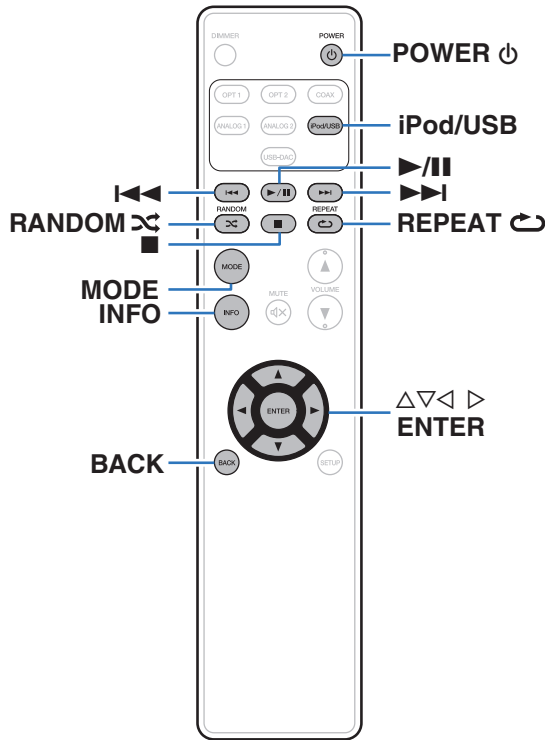

Playing an iPod

- 1 Press iPod/USB to switch the input source to “iPod/USB”.**
- 2 Connect the iPod to the USB port. (👉 p. 22)**
“From iPod” is displayed on the display of this unit.
- 3 Operate iPod itself directly while seeing the iPod screen to play back music.**



- The iPod display modes include “From iPod” and “On-Display”. By default, “From iPod”, where you directly operate the iPod itself while looking at the iPod screen, is set.

NOTE

- Marantz will accept no responsibility whatsoever for any loss of iPod data.
- Depending on the type of iPod and the software version, some functions may not operate.



Setting operation mode (On-Display mode)

In this mode, various lists and screens during playback on the iPod are displayed on this unit.

This section describes the steps up to playing back tracks on the iPod in "On-Display".

1 Press MODE.

"On-Display" is displayed on the display of this unit.

2 Use $\Delta \nabla$ to select the file to be played, then press ENTER.

Playback starts.

Operation mode		From iPod	On-Display
Playable files	Music file	✓	✓
	Video file	*	
Active buttons	Remote control unit (This unit)	✓	✓
	iPod	✓	

* Only the sound is played.

■ iPod operation

Operation buttons	Function
MODE	Setting iPod operation mode <ul style="list-style-type: none"> Switching between "From iPod" or "On-Display" mode.
INFO	Text information display <ul style="list-style-type: none"> Text information recorded on the media is displayed.
$\Delta \nabla \triangleleft \triangleright$	Select the item
\lll, \ggg	Skip to previous track / Skip to next track
\lll, \ggg (Press and hold)	Fast-reverse / Fast-forward
$\triangleright \parallel$	Playback / Pause
■	Stop
REPEAT \curvearrowright	Repeat playback (🔍 p. 44) <ul style="list-style-type: none"> Switching between All-track repeat and Single-track repeat.
RANDOM \times	Shuffle playback (🔍 p. 44)



Performing repeat playback

1 Press REPEAT .

- The current repeat play mode is indicated in the display first.
- The repeat playback mode is switched each time the button is pressed.

Repeat Off (Repeat Off):	Repeat playback mode is canceled.
Repeat One (Single-track repeat):	A file being played is played repeatedly.
Repeat All (All-track repeat):	All files in the folder currently being played are played repeatedly.

Performing random playback

1 Press RANDOM .

- The current random play mode is indicated in the display first.
- The random playback mode is switched each time the button is pressed.

Random Off (Random off):	Disable random playback.
Random On (Random on):	Randomly play back all tracks in the current playback folder.

Charging the iPod

You can charge an iPod or iPhone when the input source is switched to “iPod/USB” and the iPod or iPhone is connected to the USB port.

- If the unit enters power standby mode while the iPod/iPhone is charging, the unit will switch to standby charging mode, and the iPod/iPhone will continue to be charged. When in standby charging mode, the power display light turns orange. When charging is completed, the unit enters normal power standby mode and the power indicator turns red.



Playing a USB memory device

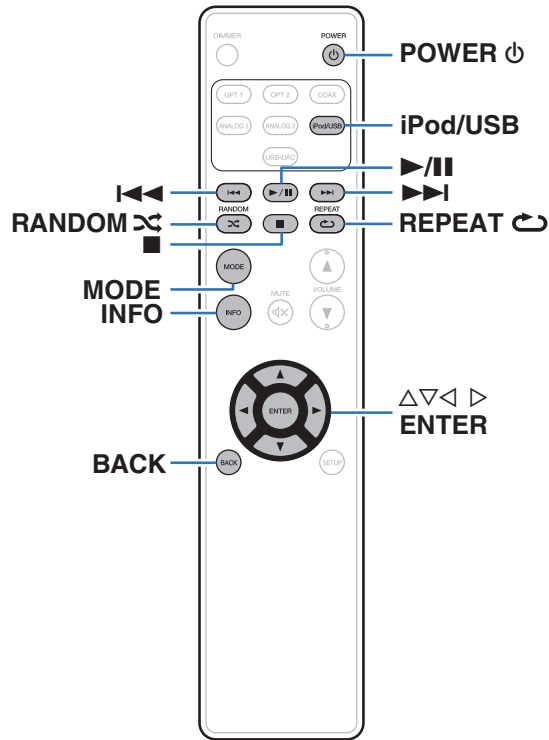

- Playing back music stored on a USB memory device.
- Only USB memory devices conforming to mass storage class standards can be played on this unit.
- This unit is compatible with USB memory devices in “FAT16” or “FAT32” format.
- This unit can play back the following files.
 - WMA
 - MP3
 - WAV
 - AAC
 - FLAC
 - ALAC
 - AIFF
 - DSD



Playing files stored on USB memory devices

- 1 Press iPod/USB to switch the input source to “iPod/USB”.**
- 2 Connect the USB memory device to the USB port.**
( p. 22)
- 3 Press MODE to select “Folder” or “All”.**
 - **About the display**
 - **When “Folder” is selected**
All the files in the selected folder are played.
 - **When “All” is selected**
After the selected folder and files are played, all the files in all the folders are played.
- 4 Use $\Delta \nabla$ to select the file or folder, then press ENTER.**
- 5 Use $\Delta \nabla$ to select the file, then press ENTER.**
Playback starts.

■ Resume function

This unit stores the point at which playback of a file was paused. When you switch the input source back to “iPod/USB” after switching to another input source or turn off the power of the unit and turn it back on later, playback from the USB memory device resumes at the point where playback was paused.

- Resume playback works even if the USB memory device is disconnected and then reconnected. However, if a different USB memory device is connected, the resume information for the previous USB memory device is deleted.
- The resume information may be deleted when the USB memory device is removed and files are added or deleted.
- Press **■** while playback is stopped to delete the resume information. “Resume Off” is displayed.

NOTE

- To play another file while playing from a USB memory device, press \triangleleft to display the folder tree, $\Delta \nabla$ to select the file to be played, and then press ENTER.
- Do not remove the USB memory device from the unit when the USB memory communication indicator is flashing. Doing so may damage the USB memory device, or may corrupt the files recorded on the USB memory device.
- Note that Marantz will accept no responsibility whatsoever for any problems arising with the data on a USB memory device when using this unit in conjunction with the USB memory device.



■ USB operation

Operation buttons	Function
MODE	Switch to Folder playback mode <ul style="list-style-type: none"> Switching between “Folder” or “All” mode.
INFO	Text information display <ul style="list-style-type: none"> Text information recorded on the media is displayed.
◀	Moving up a level in the folder tree
△ ▽	Select the item
ENTER	Enter the selected item / Playback
⏮, ⏭	Skip to previous track / Skip to next track
⏮, ⏭ (Press and hold)	Fast-reverse / Fast-forward
▶/⏸	Playback / Pause
■	Stop
REPEAT ↺	Repeat playback (🔍 p. 48) <ul style="list-style-type: none"> Switching between All-track repeat and Single-track repeat.
RANDOM 🎲	Random playback (🔍 p. 48)

■ Files that can be played back

See “Playing back a USB memory devices” (🔍 p. 65).

■ Switching the display

During playback, press INFO.

- This switches between the title name, artist name, album name, file number and file format.
- While a WAV, AIFF or DSD file is being played back, the file name, file number and file format are displayed.
- The player can display the following characters:

ABCDEFGHIJKLMNOPQRSTUVWXYZ

abcdefghijklmnopqrstuvwxyz

0123456789

! " # \$ % & ; < > ? @ \ [] _ ` { } ~ ^ ' () * + , - . / = (space)



Performing repeat playback

1 Press REPEAT .

- The current repeat play mode is indicated in the display first.
- The repeat playback mode is switched each time the button is pressed.

Repeat Off (Repeat Off):	Repeat playback mode is canceled.
Repeat One (Single-track repeat):	A file being played is played repeatedly.
Repeat All (All-track repeat):	All tracks in the playback range set by MODE (Folder/All) are played back repeatedly.

Performing random playback

1 Press RANDOM .

- The current random play mode is indicated in the display first.
- The random playback mode is switched each time the button is pressed.

Random Off (Random off):	Disable random playback.
Random On (Random on):	All tracks in the playback range set by MODE (Folder/All) are played back in random order.



Playing audio from devices connected to the ANALOG connector

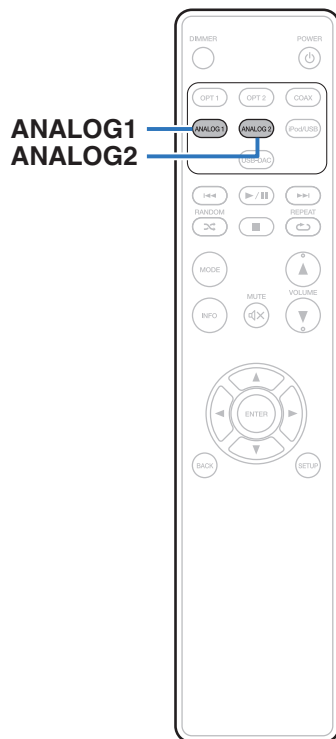

- 1 Press “ANALOG1” or “ANALOG2” to select AUDIO IN.
- 2 Play the component connected to this unit.



Menu map

By default, this unit has recommended settings defined. You can customize this unit based on your existing system and your preferences.

Setting items	Description	Page
S.Direct (Source Direct)	Sets the tone adjustment.	<u>52</u>
Bass	Adjusts the bass sound.	<u>52</u>
Treble	Adjusts the treble sound.	<u>52</u>
Balance	Adjust the left/right volume balance.	<u>52</u>
Filter	Switches the filter characteristics.	<u>53</u>
H/P Gain	Set the gain of the headphone amplifier.	<u>53</u>
Dimmer*1	This switches the brightness of the display.	<u>54</u>
iPodMode*1*2	Set whether to operate the iPod from this unit or on the iPod.	<u>54</u>
AutoStby (Auto Standby)	Sets whether to automatically switch the unit to the standby mode when the unit remains in the stop mode for more than 30 minutes.	<u>54</u>

*1 Displayed when SETUP is pressed on this unit.

*2 Displayed when the input source is "iPod/USB" and an iPod is connected.



Menu operation

1 Press **SETUP** to select the menu to be set.

Each time you press **SETUP**, the setting item changes.

2 Use **◀▶** to change to desired setting.

- You can also change the setting by turning **INPUT SELECTOR** on the main unit.

3 Press **SETUP** or **ENTER** to return to the normal display.

- The display returns to the normal display if no operations are performed for 5 seconds after configuring settings.
- To return to the normal display, press **BACK**.

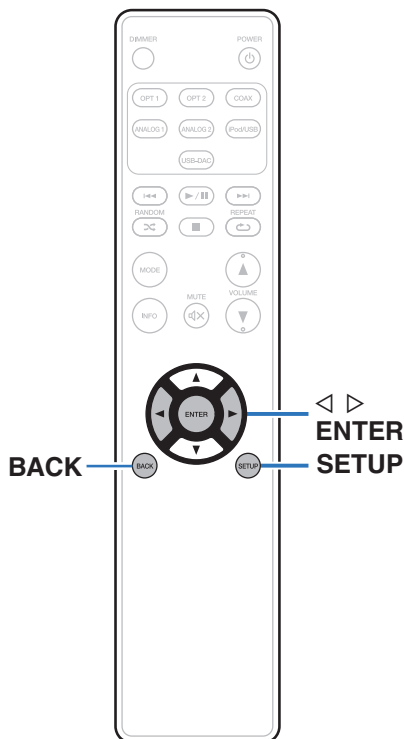

S. Direct

Set whether to adjust the tone.

Off
(Default): Adjusting the tone.

On: Tone is not adjusted. Tone adjustments
(Bass, Treble, Balance) are disabled.



- "S.Direct" is set to "On" when headphones are connected.

Bass

Adjusts the bass sound.

-8dB – +8dB
(Default : 0dB)

Treble

Adjusts the treble sound.

-8dB – +8dB
(Default : 0dB)

Balance

Adjust the left/right volume balance.

L6 - Center - R6
(Default : Center)



Filter

This unit is equipped with a sound quality adjusting function which allows users to enjoy the desired playback sound quality. The unit supports PCM and analog input signals.

FIL 1 (Default):

Offers a short impulse response for both pre-echo and post-echo. Suitable for large-information content audio. Produces a deep sound image with clearly-defined positional relationships of the audio sources.

FIL 2:

This is a long coefficient FIR filter with symmetric pre-echo and post-echo in the impulse response. Resembles analog sound quality.

H/P Gain

Set the gain of the headphone amplifier. Set this according to the impedance of the connected headphones. It is recommended that this is set on the “Low” side if the headphones have low impedance and on the “High” side if they have high impedance.

Low
(Default): Set the gain of the headphone amplifier to “Low”.

Mid: Set the gain of the headphone amplifier to “Mid”.

High: Set the gain of the headphone amplifier to “High”.

NOTE

- The headphone volume varies depending on the “H/P Gain” setting. Decrease the volume or mute the audio first if changing this setting while listening to audio.



Dimmer

This switches the brightness of the display.

Off: Turns the display off.

Dark: Very low display brightness.

Dim: Reduced display brightness.

**Bright
(Default):** Normal display brightness.



- You can also adjust the display by pressing DIMMER on the remote control unit.

iPodMode

Set whether to operate the iPod from this unit or on the iPod.

From iPod: Operate the iPod on the iPod itself.

On-Display: Operate the iPod from this unit and the remote control unit.



- Operation mode can also be switched by pressing MODE on the remote control unit.

AutoStby

When this unit is in the stop state and there is no input signal and operation for 30 minutes, it automatically enters the standby mode.

On: Enable Auto Standby mode.

**Off
(Default):** Disable Auto Standby mode.



- When iPod is being charged, this unit enters the power standby mode after charging.



Contents

■ Tips

I want to enjoy analog output audio at higher quality	56
I want to playback just the specified folder	56
I want to delete the resume information for playback of a USB memory device	56
I want to display the title, etc. of the file currently playing back on the iPod on this unit's display	56
I want to adjust the tone myself	56
I want sound playback that is faithful to the original sound	56
I want to switch the filter to change the tone.	56

■ Troubleshooting

Power does not turn on / Power is turned off	57
Operations cannot be performed through the remote control unit	59
Display on this unit shows nothing	59
No sound comes out	60
Sound is interrupted or noise occurs	60
Desired sound does not come out	61
PC or Mac files cannot be played back	61
Audio from digital devices cannot be played back (Coaxial/Optical)	62
iPod cannot be played back	62
USB memory devices cannot be played back	63
File names on the iPod/USB memory device are not displayed properly	64



Tips

I want to enjoy analog output audio at higher quality

- Press the DIMMER button to turn the display off. (🔍 p. 29)

I want to playback just the specified folder

- Press the MODE button to set the playback mode to “Folder”. (🔍 p. 46)

I want to delete the resume information for playback of a USB memory device

- In the stop mode, press the ■ button. (🔍 p. 46)

I want to display the title, etc. of the file currently playing back on the iPod on this unit’s display

- Press the MODE button to set “On-Display” mode. (🔍 p. 43)

I want to adjust the tone myself

- Adjust the “Bass”, “Treble” and “Balance” in the setup menu to the desired levels. (🔍 p. 52)

I want sound playback that is faithful to the original sound

- Set “Source Direct” in the setup menu to “On”. (🔍 p. 52)

I want to switch the filter to change the tone

- Set the desired filter using “Filter” in the settings menu. (🔍 p. 53)





Troubleshooting

1. Are the connections correct?
2. Is the set being operated as described in the owner's manual?
3. Are the other devices operating properly?

If this unit does not operate properly, check the items listed in the table below.

Should the problem persist, there may be a malfunction. In this case, disconnect the power immediately and contact your store of purchase.

■ Power does not turn on / Power is turned off

Symptom	Cause / Solution	Page
Power is not turned on.	• Check whether the power plug is correctly inserted into the power outlet.	25
	• This unit is in standby mode. Press the  button on the unit or the POWER  button on the remote control.	27
Power automatically turns off.	• The Auto Standby mode is on. The Auto Standby mode switches the unit to standby mode when the unit is not operated for approximately 30 minutes. To disable Auto Standby mode, set "AutoStby" on the menu to "Off".	54
Power turns off and the standby indicator flashes in red approx. every 2 seconds.	• The protection circuit has been activated due to a rise in temperature within this unit. Turn the power off, wait about an hour until this unit cools down sufficiently, and then turn the power on again.	27
	• Please re-install this unit in a place having good ventilation.	—
Power turns off and the standby indicator flashes in red approx. every 0.5 seconds.	• Check the speaker connections. The protection circuit may have been activated because speaker cable core wires came in contact with each other or a core wire was disconnected from the connector and came in contact with the rear panel of this unit. After unplugging the power cord, firmly re-twist the core wire, and then reconnect the wire.	17
	• Turn down the volume and turn on the power again.	27
	• This unit's amplifier circuit has failed. Unplug the power cord and contact our customer service center.	—



Symptom	Cause / Solution	Page
Power turns off and the standby indicator flashes in red approx. every 0.25 seconds.	<ul style="list-style-type: none">The USB memory device is not supported. Please use a USB memory device with an operating current that is less than 1A.	—
	<ul style="list-style-type: none">The voltage able to be supplied from this unit via the USB memory device has been exceeded. Remove the power cable from the wall socket, remove the USB memory device and switch the power on again.	—



■ Operations cannot be performed through the remote control unit

Symptom	Cause / Solution	Page
Operations cannot be performed through the remote control unit.	• Batteries are worn out. Replace with new batteries.	<u>6</u>
	• Operate the remote control unit within a distance of about 23 ft/7 m from this unit and at an angle of within 30°.	<u>6</u>
	• Remove any obstacle between this unit and the remote control unit.	—
	• Insert the batteries in the proper direction, checking the ⊕ and ⊖ marks.	<u>6</u>
	• The set's remote control sensor is exposed to strong light (direct sunlight, inverter type fluorescent bulb light, etc.). Move the set to a place in which the remote control sensor will not be exposed to strong light.	—
	• When using a 3D video device, the remote control unit of this unit may not function due to effects of infrared communications between units (such as TV and glasses for 3D viewing). In this case, adjust the direction of units with the 3D communications function and their distance to ensure they do not affect operations from the remote control unit of this unit.	—

■ Display on this unit shows nothing

Symptom	Cause / Solution	Page
Display is off.	• Press the DIMMER button, and change the setting to anything other than off.	<u>29</u>



■ No sound comes out

Symptom	Cause / Solution	Page
No sound is produced. Or sound is distorted.	• Check the connections for all devices.	<u>16</u>
	• Insert connection cables all the way in.	—
	• Check cables for damage.	—
	• Check that speaker cables are properly connected. Check that cable core wires come in contact with the metal part on speaker terminals.	<u>17</u>
	• Securely tighten the speaker terminals. Check speaker terminals for looseness.	<u>17</u>
	• Check that a proper input source is selected.	<u>28</u>
	• The volume is set to the minimum level. Adjust the volume to a suitable level.	<u>28</u>
	• Cancel the mute mode.	<u>28</u>
	• No sound is output from the speakers when headphones are connected.	<u>10</u>

■ Sound is interrupted or noise occurs

Symptom	Cause / Solution	Page
Sound is interrupted during playback of tracks saved on a computer.	• Do not start applications other than the player software while playing music on your computer.	—



■ Desired sound does not come out

Symptom	Cause / Solution	Page
Left/right volume balance is unbalanced.	<ul style="list-style-type: none"> Press the SETUP button on the remote control to adjust the balance. 	52
No sound from the subwoofer.	<ul style="list-style-type: none"> Check the subwoofer connections. 	19
	<ul style="list-style-type: none"> Switch the subwoofer power on. 	—
Set values are not reflected in “Bass” and “Treble”.	<ul style="list-style-type: none"> “Bass” and “Treble” setting values are not reflected in Subwoofer out. 	52
	<ul style="list-style-type: none"> Set “Off” to the “S.Direct”. 	52
Headphone volume is low.	<ul style="list-style-type: none"> Switch “H/P Gain” to “Mid” or “High” if using headphones with high impedance or low sensitivity. 	53

■ PC or Mac files cannot be played back

Symptom	Cause / Solution	Page
This unit is not recognized on the computer.	<ul style="list-style-type: none"> Reconnect the USB cable to the USB port on your computer. When this unit is still not recognized after reconnection, connect to a different USB port. 	21
	<ul style="list-style-type: none"> Restart your computer. 	—
	<ul style="list-style-type: none"> Check the OS of your computer. 	31
	<ul style="list-style-type: none"> When your computer is running on Windows, a dedicated driver software should be installed. 	31
This unit is not selected as the playback device.	<ul style="list-style-type: none"> Select this unit as the playback device in the sound settings on the computer. 	31
“Unlocked” is displayed.	<ul style="list-style-type: none"> When digital audio signals cannot be detected properly, “Unlocked” is displayed. 	39
“Unsupported” is displayed.	<ul style="list-style-type: none"> “Unsupported” is displayed when audio signals that are not supported by this unit are input. Check the settings on your computer or player software. 	39
	<ul style="list-style-type: none"> If the computer you use is “Mac OS”, please check if the “HD-AMP1” format is set below “384000.0 Hz” using the “Audio MIDI Setup”. 	38



■ Audio from digital devices cannot be played back (Coaxial/Optical)

Symptom	Cause / Solution	Page
"Unlocked" is displayed.	<ul style="list-style-type: none"> When digital audio signals cannot be detected properly, "Unlocked" is displayed. 	40
"Unsupported" is displayed.	<ul style="list-style-type: none"> "Unsupported" is displayed when audio signals that are not supported by this unit are input. Check the audio output signal format from your digital device. 	40

■ iPod cannot be played back

Symptom	Cause / Solution	Page
iPod cannot be connected or "Error 1" is displayed.	<ul style="list-style-type: none"> When using iPod by connecting it to the USB port, some iPod variations are not supported. 	23
	<ul style="list-style-type: none"> When iPod is connected by using a USB cable other than the genuine cable, iPod may not be recognized. Use a genuine USB cable. 	—



■ USB memory devices cannot be played back

Symptom	Cause / Solution	Page
"No USB Device", "Error 1", "Error 3" or "Error 4" is displayed.	<ul style="list-style-type: none"> This unit may not recognize the USB memory device due to poor connection, etc. Make sure that the connection is made properly by taking actions such as disconnecting and reconnecting the USB memory device. 	<u>22</u>
	<ul style="list-style-type: none"> Mass storage class compatible USB memory devices are supported. 	—
	<ul style="list-style-type: none"> This unit does not support a connection through a USB hub. Connect the USB memory device directly to the USB port. 	—
	<ul style="list-style-type: none"> The USB memory device must be formatted to FAT16 or FAT32. 	—
	<ul style="list-style-type: none"> Not all USB memory devices are guaranteed to work. Some USB memory devices are not recognized. When using a type of portable hard disc drive compatible with the USB connection that requires power from an AC adapter, use the AC adapter that came with the drive. 	—
Files on the USB memory device are not displayed or "Error 2" is displayed.	<ul style="list-style-type: none"> Files of a type not supported by this unit are not displayed. 	<u>65</u>
	<ul style="list-style-type: none"> This unit can display a file structure with up to 8 levels, up to 200 folders and up to 2,000 files in total. Modify the folder structure of the USB memory device. 	—
	<ul style="list-style-type: none"> When multiple partitions exist on the USB memory device, only files on the first partition are displayed. 	—
Files on a USB memory device cannot be played.	<ul style="list-style-type: none"> Files are created in a format that is not supported by this unit. Check the formats supported by this unit. 	<u>65</u>
	<ul style="list-style-type: none"> Files that are copyright protected cannot be played on this unit. 	—
	<ul style="list-style-type: none"> If a file is unplayable, "Unsupported" is displayed and the next file is played. 	—



■ File names on the iPod/USB memory device are not displayed properly

Symptom	Cause / Solution	Page
The file names are not displayed properly ("...", etc.).	<ul style="list-style-type: none">Characters that cannot be displayed have been used. On this unit, characters that cannot be displayed are replaced with a "." (period).	—



Playing back a USB memory devices

■ USB-compatible file systems

FAT16 or FAT32

- If the USB memory device is divided into multiple partitions, only the top drive can be selected.

■ Tag data

ID3-TAG (Ver.1.x and 2.x)

WMA-TAG

AAC-TAG

(The title, artist, and album tag data are supported)

■ Compatible formats

	Sampling frequency	Bit rate	Bit length	Extension
WMA*1	32/44.1/48 kHz	48 – 320 kbps	–	.wma
MP3	32/44.1/48 kHz	32 – 320 kbps	–	.mp3
AAC*1	32/44.1/48 kHz	16 – 320 kbps	–	.aac/ .m4a/ .mp4

	Sampling frequency	Bit rate	Bit length	Extension
WAV	32/44.1/48/ 88.2/96/176.4/ 192 kHz	–	16/24 bits	.wav
FLAC	32/44.1/48/ 88.2/96/176.4/ 192 kHz	–	16/24 bits	.flac
ALAC*2	32/44.1/48/ 88.2/96 kHz	–	16/24 bits	.m4a
AIFF	32/44.1/48/ 88.2/96/176.4/ 192 kHz	–	16/24 bits	.aif/ .aiff
DSD (2-channel)	2.8/5.6 MHz	–	–	.dsf/ .dff

- *1 Only files that are not protected by copyright can be played on this unit. Content downloaded from pay sites on the Internet are copyright protected. Also, files encoded in WMA format when ripped from a CD, etc., on a computer may be copyright protected, depending on the computer's settings.
- *2 Copyright [2012] [D&M Holdings, Inc.] Licensed under the Apache License, Version 2.0 (the "License"); you may not use this file except in compliance with the License. You may obtain a copy of the License at <http://www.apache.org/licenses/LICENSE-2.0>



- If the image size of an album artwork exceeds 1.5 MB, then music may not be played back properly.



■ Maximum number of playable files and folders

Number of files : 2,000

Number of folders : 200

Maximum number of files in a folder : 255



- This unit can only play music files that are not copyright protected.
- Content downloaded from pay sites on the Internet are copyright protected. Also, files encoded in WMA format when ripped from a CD, etc., on a computer may be copyright protected, depending on the computer's settings.

NOTE

- It is not compatible with an MP3 player, digital camera, a USB device for a mobile phone, etc.
- The unit cannot charge a USB device.

Playback order of files

If there are multiple folders containing music files, the files are played in order of folder name. The files in each folder are also played in name order.

- For playback of files recorded on USB, files in the first folder on the first layer are played first, next folders on the second layer in the folder, then next on the third layer, and so on in this order. Then accordingly files on another first layer are played.



- The playback order displayed on a PC may differ from the actual playback order.



About folders and files

Music files recorded on a USB memory device are divided into large segments (folders) and small segments (files). Files are stored in folders, and folders can be placed for storage in a hierarchy. The unit can recognize up to 8 levels of folders.

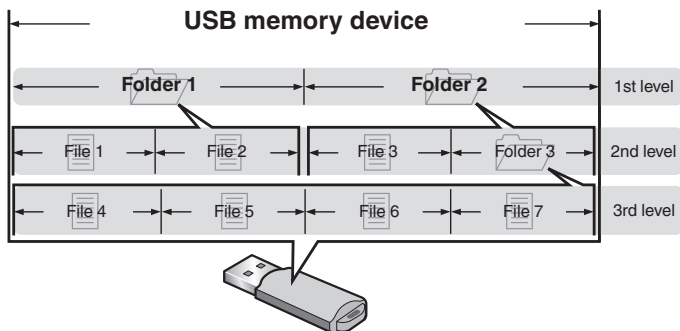

How to handle media

- Do not eject a USB memory device or turn off the unit while a USB memory device is being played. This may result in malfunction or loss of the USB memory device's data.
- Do not attempt to open or modify a USB memory device.
- USB memory device and files can be damaged by static electricity. Do not touch the metal contacts of a USB memory device with your fingers.
- Do not use warped USB memory device.
- After use, be sure to remove any USB memory device, and store it in its proper case, to avoid dust, scratches and deformation.
- Do not store discs in the following places:
 1. Places exposed to direct sunlight for long periods of time
 2. Dusty or humid places
 3. Places exposed to heat from heaters, etc.



D/A converter

■ Specifications of supported audio formats

□ USB-DAC

	Sampling frequency	Bit length
DSD (2-channel)	2.8/5.6/11.2 MHz	1 bit
Linear PCM (2-channel)	44.1/48/88.2/96/176.4/ 192/352.8/384 kHz	16/24/32 bits

□ Coaxial/Optical

	Sampling frequency	Bit length
Linear PCM (2-channel)	32/44.1/48/64/88.2/96/ 176.4/192 kHz	16/24 bits



Explanation of terms

ALAC (Apple Lossless Audio Codec)

This is a codec for lossless audio compression method developed by Apple Inc. This codec can be played back on iTunes, iPod or iPhone. Data compressed to approximately 60 – 70 % can be decompressed to exactly the same original data.

DSD (Direct-Stream Digital)

One of the audio data recording methods, it is the signal aspect used to store audio signals on a super audio CD, and is Δ - Σ modulated digital audio. It is configured of an array of single bit values at a 2.8 MHz sampling rate.

FLAC (Free Lossless Audio Codec)

FLAC stands for Free lossless Audio Codec, and is a lossless free audio file format. Lossless means that the audio is compressed without any loss in quality.

The FLAC license is as shown below.

Copyright (C) 2000,2001,2002,2003,2004,2005,2006,2007,2008,2009
Josh Coalson

Redistribution and use in source and binary forms, with or without modification, are permitted provided that the following conditions are met:

MP3 (MPEG Audio Layer-3)

This is an internationally standardized audio data compression scheme, using the “MPEG-1” video compression standard. It compresses the data volume to about one eleventh its original size while maintaining sound quality equivalent to a music CD.

MPEG (Moving Picture Experts Group), MPEG-2, MPEG-4

These are the names for digital compression format standards used for the encoding of video and audio. Video standards include “MPEG-1 Video”, “MPEG-2 Video”, “MPEG-4 Visual”, “MPEG-4 AVC”. Audio standards include “MPEG-1 Audio”, “MPEG-2 Audio”, “MPEG-4 AAC”.



WMA (Windows Media Audio)

This is the audio compression technology developed by Microsoft Corporation.

WMA data can be encoded using Windows Media® Player.

To encode WMA files, only use applications authorized by Microsoft Corporation. If you use an unauthorized application, the file may not work properly.

Sampling frequency

Sampling involves taking a reading of a sound wave (analog signal) at regular intervals and expressing the height of the wave at each reading in digitized format (producing a digital signal).

The number of readings taken in one second is called the “sampling frequency”. The larger the value, the closer the reproduced sound is to the original.

Speaker impedance

This is an AC resistance value, indicated in Ω (ohms).

Greater power can be obtained when this value is smaller.

Dynamic range

The difference between the maximum undistorted sound level and the minimum discernible level above the noise emitted by the device.

Bit rate

This expresses the read amount per 1 second of video/audio data recorded in a disc. A larger number means higher sound quality, but also means a larger file size.

Protection circuit

This is a function to prevent damage to devices within the power supply when an abnormality such as an overload, excess voltage occurs or over temperature for any reason.

Linear PCM

This is an uncompressed PCM (Pulse Code Modulation) signal. This is the same system used for CD audio but uses 192 kHz, 96 kHz, and 48 kHz sampling frequencies on Blu-ray Disc or DVD and provides higher resolution than CD.



Trademark information



“Made for iPod” and “Made for iPhone” mean that an electronic accessory has been designed to connect specifically to iPod, or iPhone, respectively, and has been certified by the developer to meet Apple performance standards.

Apple is not responsible for the operation of this device or its compliance with safety and regulatory standards. Please note that the use of this accessory with iPod, or iPhone, may affect wireless performance. iPad, iPhone, iPod, iPod classic, iPod nano, iPod shuffle and iPod touch are trademarks of Apple Inc., registered in the U.S. and other countries.

- Individual users are permitted to use iPhone, iPod, iPod classic, iPod nano, iPod shuffle, and iPod touch for private copy and playback of non-copyrighted contents and contents whose copy and playback is permitted by law. Copyright infringement is prohibited by law.



Adobe, the Adobe logo and Reader are either registered trademarks or trademarks of Adobe Systems Incorporated in the United States and/or other countries.



Specifications

■ Audio performance

Rated output:	35 W + 35 W (8 Ω /ohms, 20 Hz - 20 kHz, THD+N 0.1 %)
Dynamic power:	70 W + 70 W (4 Ω /ohms, 20 Hz - 20 kHz, THD+N 0.1 %)
Output connectors:	Speaker: 4-16 Ω /ohms (impedance) Compatible with headphones/stereo headphones
Playable frequency range:	2 Hz – 96 kHz
Playable frequency response:	2 Hz – 50 kHz (–3 dB) (DSD mode, PCM sampling frequency: 192 kHz) 2 Hz – 20 kHz (PCM sampling frequency: 44.1 kHz)
S/N:	105 dB (Audible range)
Harmonic distortion:	0.05 % (1 kHz, Audible range)



- Analog input

Input sensitivity/impedance: 200 mVrms/22 k Ω /kohms

- Digital input

Coaxial: 0.5 Vp-p / 75 Ω /ohms

Optical : -27 dBm or lator

USB (Front): USB Type A (USB 2.0 High speed)

USB (Rear): USB Type B (USB 2.0 High speed)

■ General

Power supply voltage/frequency: AC120 V, 60 Hz

Power consumption (EN60065) : 55 W

Power consumption in standby mode: 0.3 W

For the purpose of improvement, the specifications and design are subject to change without notice.



■ Dimensions (Unit : in. (mm))

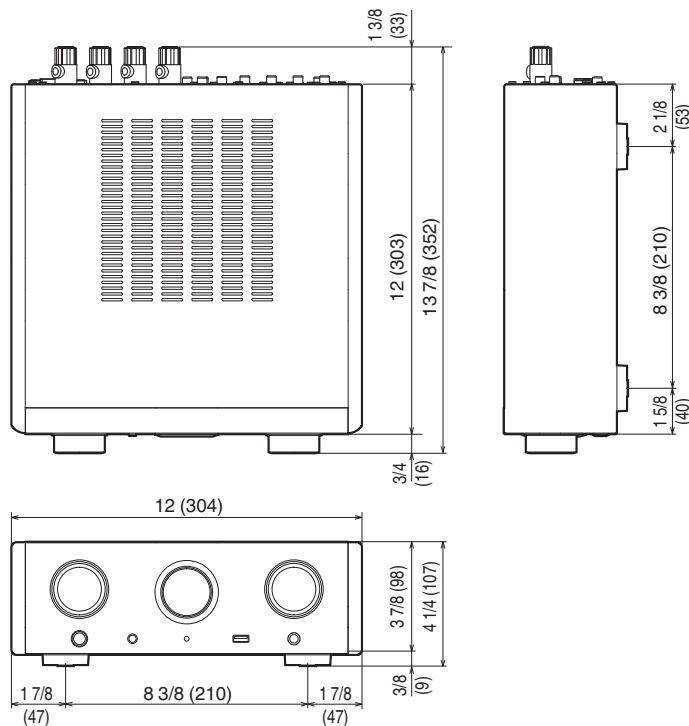

■ Weight : 12 lbs 13 oz (5.8 kg)

Index

D	
D/A converter function	30, 68
Display's brightness	29
DSD	68, 69
F	
Front panel	9
I	
Input source	28
iPod	22, 41, 44
M	
Menu map	50

P	
PC	21
R	
Random playback	44, 48
Rear panel	12
Remote control connection	24
Remote control unit	13
Repeat playback	44, 48
U	
USB	22, 45
USB-DAC	21, 30, 68





www.marantz.com

You can find your nearest authorized distributor or dealer on our website.

marantz[®] is a registered trademark.

3520 10426 01AM

Copyright ©2015 D&M Holdings Inc. All Rights Reserved.