

marantz®

AV Surround Receiver

SR5008

You can print more than one page of a PDF onto a single sheet of paper.

[Front panel](#)[Display](#)[Rear panel](#)[Remote](#)[Index](#)

Owner's Manual

Contents

Accessories	<u>7</u>
Inserting the batteries	<u>8</u>
Operating range of the remote control unit	<u>8</u>
Features	<u>9</u>
High quality sound	<u>9</u>
High performance	<u>9</u>
Easy operation	<u>10</u>

Part names and functions

Front panel	<u>11</u>
Display	<u>14</u>
Rear panel	<u>16</u>
Remote control unit	<u>19</u>

Connections

Speaker connection	<u>22</u>
Speaker installation	<u>22</u>
Speaker connection	<u>25</u>
Connecting a TV	<u>32</u>
Connection 1 : TV equipped with an HDMI connector and compatible with the ARC (Audio Return Channel)	<u>33</u>
Connection 2 : TV equipped with an HDMI connector	<u>34</u>
Connection 3 : TV equipped without an HDMI connector	<u>35</u>

Connecting a playback device	<u>36</u>
Connecting a set-top box (Satellite tuner/cable TV)	<u>37</u>
Connecting a DVD player	<u>38</u>
Connecting a video camcorder or other device	<u>39</u>
Connecting a device with a multi-channel output connector	<u>40</u>
Connecting an iPod or USB memory device to the USB port	<u>41</u>
Connecting an FM/AM antenna	<u>43</u>
Connecting to a home network (LAN)	<u>45</u>
Connecting a wireless receiver (RX101)	<u>47</u>
Connecting an external control device	<u>48</u>
Remotely connecting Marantz devices	<u>48</u>
Remotely control a Marantz Blu-ray Disc player by the Marantz Remote App	<u>49</u>
DC OUT jack	<u>49</u>
Connecting the power cord	<u>50</u>

Playback

Basic operation	<u>52</u>
Turning the power on	<u>52</u>
Selecting the input source	<u>52</u>
Adjusting the master volume	<u>53</u>
Turning off the sound temporarily	<u>53</u>
Playing a DVD player/Blu-ray Disc player	<u>53</u>



Playing an iPod	<u>54</u>	Viewing photographs on the Flickr site	<u>76</u>
Listening to music on an iPod.....	<u>55</u>	Viewing photographs shared by particular users	<u>77</u>
Setting operation mode (iPod Browse Mode).....	<u>56</u>	Viewing all photographs on Flickr.....	<u>78</u>
Performing repeat playback (Repeat).....	<u>57</u>	Listening to Pandora®	<u>80</u>
Performing random playback (Random).....	<u>57</u>	Listening to Pandora®	<u>81</u>
Playing a USB memory device	<u>58</u>	Creating a new station	<u>82</u>
Playing files stored on USB memory devices	<u>59</u>	Listening to an existing station	<u>84</u>
Listening to FM/AM broadcasts	<u>61</u>	Listening to created radio stations at random.....	<u>84</u>
Listening to FM/AM broadcasts.....	<u>62</u>	Giving Feedback and Managing Stations	<u>85</u>
Tuning in by entering the radio frequency (Direct Tune).....	<u>63</u>	Sign Out	<u>86</u>
Changing the tuning mode (Tune Mode)	<u>64</u>	Listening to SiriusXM Internet Radio	<u>87</u>
Listening to preset stations.....	<u>64</u>	Listening to SiriusXM Internet Radio	<u>87</u>
Presetting the current broadcast station (Preset Memory).....	<u>65</u>	Sign Out	<u>89</u>
Tuning in to radio stations and presetting them automatically (Auto Preset Memory).....	<u>66</u>	Listening to Spotify	<u>90</u>
Specify a name for the preset broadcast station (Preset Name) ..	<u>66</u>	Listening to Spotify	<u>90</u>
Skipping preset broadcast stations (Preset Skip)	<u>67</u>	Adding to the FAVORITE STATION button	<u>94</u>
Cancelling preset skip	<u>67</u>	Playing back content added to the FAVORITE STATION button.....	<u>95</u>
Listening to Internet Radio	<u>68</u>	AirPlay function	<u>96</u>
Listening to Internet Radio.....	<u>69</u>	Streaming music stored in iPhone, iPod touch, or iPad directly to the unit	<u>96</u>
Playing the last played Internet Radio station	<u>70</u>	Playing iTunes music with this unit.....	<u>97</u>
Using vTuner to add Internet Radio stations to favorites.....	<u>71</u>	Selecting multiple speakers (devices).....	<u>97</u>
Playing back files stored on a PC and NAS	<u>72</u>	Perform iTunes playback operations with the remote control unit of this unit	<u>98</u>
Applying media sharing settings	<u>73</u>		
Playing back files stored on a PC and NAS	<u>74</u>		



Convenience functions	<u>99</u>
Performing repeat playback (Repeat)	<u>100</u>
Performing random playback (Random)	<u>100</u>
Add to favorites from the Option menu (Save to Favorites)	<u>101</u>
Playing back content added in "Save to Favorites"	<u>101</u>
Deleting content added to favorites (Remove from Favorites)	<u>102</u>
Searching content with keywords (Text Search)	<u>102</u>
Playing back music and a favorite picture at the same time (Slideshow)	<u>103</u>
Playing back still pictures in sequential order (Slideshow Interval)	<u>104</u>
Displaying your desired video during audio playback (Video Select)	<u>104</u>
Adjusting the picture quality for your viewing environment (Picture Mode)	<u>105</u>
Playing music in All Zone Stereo	<u>106</u>
Selecting a sound mode	<u>107</u>
Selecting a sound mode	<u>108</u>
Direct playback	<u>109</u>
Pure Direct playback	<u>109</u>
Auto surround playback	<u>110</u>
HDMI control function	<u>119</u>
Setting procedure	<u>119</u>
Sleep timer function	<u>120</u>
Using the sleep timer	<u>120</u>
Web control function	<u>121</u>
Controlling the unit from a web control	<u>121</u>

Dual backup memory function	<u>123</u>
Remembering set details (Backup)	<u>123</u>
Recalling remembered details (Recovery)	<u>123</u>
Panel lock function	<u>124</u>
Disabling all key button operations	<u>124</u>
Disabling all button operations except VOLUME	<u>124</u>
Canceling the Panel lock function	<u>125</u>
Remote lock function	<u>126</u>
Disabling the sensor function of the remote control unit	<u>126</u>
Enabling the remote sensor function	<u>126</u>
Playback in ZONE2 (Separate room)	<u>127</u>
Connecting ZONE2	<u>127</u>
Playback in ZONE2	<u>129</u>

Settings

Menu map	<u>131</u>
Menu operation	<u>137</u>
Inputting characters	<u>138</u>
Keyboard screen	<u>138</u>
Audio	<u>139</u>
Dialog Level	<u>139</u>
Subwoofer Level	<u>139</u>
Surround Parameter	<u>140</u>
Tone	<u>143</u>
M-DAX	<u>143</u>
Audio Delay	<u>144</u>
Volume	<u>144</u>
Audyssey	<u>145</u>
Graphic EQ	<u>147</u>



Video	<u>148</u>	Network	<u>173</u>
Picture Adjust	<u>148</u>	Information	<u>173</u>
HDMI Setup	<u>149</u>	IP Control	<u>173</u>
Output Settings	<u>151</u>	Friendly Name	<u>173</u>
On Screen Display	<u>153</u>	Settings	<u>174</u>
TV Format	<u>153</u>	Diagnostics	<u>175</u>
Inputs	<u>154</u>	Maintenance Mode	<u>176</u>
Input Assign	<u>154</u>	General	<u>177</u>
Source Rename	<u>156</u>	Language	<u>177</u>
Hide Sources	<u>156</u>	ZONE2 Setup	<u>177</u>
Source Level	<u>156</u>	Zone Rename	<u>178</u>
Input Select	<u>157</u>	Trigger Out	<u>178</u>
Speakers	<u>158</u>	Auto Standby	<u>179</u>
Audyssey® Setup	<u>158</u>	Front Display	<u>179</u>
Procedure for speaker settings (Audyssey® Setup)	<u>160</u>	Information	<u>179</u>
Error messages	<u>165</u>	Usage Data	<u>181</u>
Retrieving Audyssey® Setup settings	<u>166</u>	Firmware	<u>181</u>
Manual Setup	<u>167</u>	Setup Lock	<u>183</u>
Amp Assign	<u>167</u>	Specifying the zone used	
Speaker Config.	<u>168</u>	with the remote control unit	<u>184</u>
Distances	<u>170</u>		
Levels	<u>170</u>		
Crossovers	<u>171</u>		
Bass	<u>172</u>		
Front Speaker	<u>172</u>		



Tips

Contents	<u>185</u>
Tips.....	<u>186</u>
Troubleshooting	<u>188</u>
Resetting factory settings	<u>200</u>

Appendix

About HDMI.....	<u>201</u>
Video conversion function.....	<u>204</u>
Playing back USB memory devices.....	<u>206</u>
Playing back files stored on PC or NAS	<u>207</u>
Playing back Internet Radio	<u>208</u>
Personal memory plus function	<u>208</u>
Last function memory.....	<u>208</u>
Sound modes and channel output.....	<u>209</u>
Sound modes and surround parameters	<u>210</u>
Types of input signals, and corresponding sound modes	<u>213</u>
Explanation of terms	<u>216</u>
Trademark information.....	<u>223</u>
Specifications	<u>225</u>
Index	<u>227</u>
License	<u>230</u>



Thank you for purchasing this Marantz product. To ensure proper operation, please read this owner's manual carefully before using the product. After reading this manual, be sure to keep it for future reference.

Accessories

Check that the following parts are supplied with the product.

① Getting Started

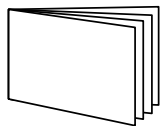

② CD-ROM (Owner's Manual)

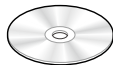

③ Safety Instructions

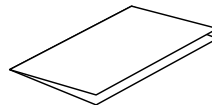

④ Warranty
(for USA)
(for CANADA)

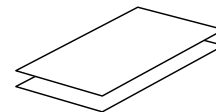

⑤ Power cord



⑥ Remote control unit (RC021SR)

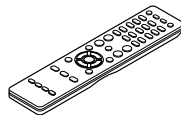

⑦ R03/AAA batteries



⑧ AM loop antenna



⑨ FM indoor antenna



⑩ Setup and measurement
microphone (ACM1HB)



⑪ Cable label

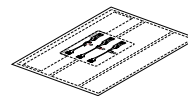

Inserting the batteries

- 1 Remove the rear lid in the direction of the arrow and remove it.

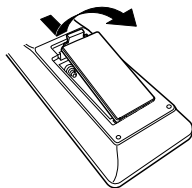

- 2 Load the two batteries properly as indicated by the ⊕ and ⊖ marks in the battery compartment.

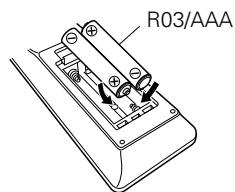

- 3 Put the rear cover back on.

NOTE

- When inserting the batteries, be sure to do so in the proper direction, following the ⊕ and ⊖ marks in the battery compartment.
- To prevent damage or leakage of battery fluid:
 - Do not use a new battery together with an old one.
 - Do not use two different types of batteries.
- Remove the batteries from the remote control unit if it will not be in use for long periods.
- If the battery fluid should leak, carefully wipe the fluid off the inside of the battery compartment and insert new batteries.

Operating range of the remote control unit

Point the remote control unit at the remote sensor when operating it.

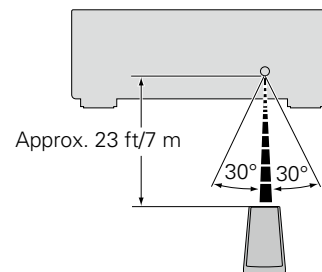

Features

High quality sound

- **With discrete circuit technology, the power amplifier provides identical quality for all 7-channels (140 Watts x 7-channels)**

For optimum realism and stunning dynamic range, the power amplifier section features discrete power devices (not integrated circuitry).

By using high current, high power discrete power devices, the amplifier is able to easily drive high quality speakers.

- **Current feedback amplifier**

This unit uses a high-speed current feedback amplifier circuit for its preamplifier so that signals from a Blu-ray Disc player and other equipment that support high-definition audio formats can be amplified with high fidelity. The high-speed current feedback amplifier also reproduces a natural sound space.

High performance

- **Digital video processor upscales analog video signals (SD resolution) to HD (720p/1080p) and 4K (🔗 page 201)**

This unit features a sophisticated video processor that can upscale standard definition (SD) analog video content from legacy sources such as a VCR to HD and is able to output at 4K Ultra HD resolution (3840 x 2160 pixels) for compatibility with newly available high 4K TVs.

- **Supports Internet Radio, music, and photograph streaming Supports AirPlay® (🔗 page 96)**

You can enjoy a wide variety of content, including listening to Internet Radio, playing audio files stored on your PC, and displaying photographs stored on your PC on our television.

This unit also supports Apple AirPlay which lets you stream your music library from an iPhone®, iPad®, iPod touch® or iTunes®.

- **Compatible with “Marantz Remote App” for performing basic operations of the unit with an iPad, iPhone or Android* smartphone**

“Marantz Remote App” is application software that allows you to perform basic operations with an iPad, iPhone, Android smartphone or Android tablet such as turning the unit ON/OFF, controlling the volume, and switching the source.

* Download the appropriate “Marantz Remote App” for iOS and Android devices. This unit needs to be connected to your LAN and the iPhone/iPod touch or other device needs to be connected to the same network by Wi-Fi (wireless LAN).



- **HDMI connections enable quick connection to various digital AV devices (7 inputs, 1 output)**

The unit is equipped with 7 HDMI input connectors for connecting devices with HDMI connectors, such as a Blu-ray Disc player, game console, HD digital camcorder, HDTVs, etc.

- **Supports HDMI (3D, ARC, Deep Color, “x.v.Color”, Auto Lip Sync, 4K) and HDMI control function (👉 page 201)**

Advanced HDMI features are supported, including 3D passthrough, Audio Return Channel, Auto Lip Sync, Deep Color and “x.v.Color”, and HDMI CEC control functions. If a 4K digital video signal is input, it is passed through the unit unchanged, and the GUI overlay will adjust the resolution accordingly.

- **Direct play for iPod and iPhone via USB (👉 page 41)**

Music data from an iPod or iPhone can be played back if you connect the USB cable supplied with the iPod via the USB port of this unit, and also an iPod and iPhone can be controlled with the remote control that comes with this unit.

- **Multi-Room audio**

Enjoy the same music in your home theater and another room at the same time (👉 page 106).

- **M-XPport (Marantz-eXtension Port) (👉 page 47)**

This unit is equipped with the M-XPport, a Marantz original innovation that provides outstanding expandability. You can connect the Wireless Receiver RX101 (sold separately) to this port.

Easy operation

- **“Setup Assistant” provides easy-to-follow setup instructions**

First select the language when prompted. Then simply follow the instructions displayed on the TV screen to set up the speakers, network, etc.

- **Easy to use Graphical User Interface**

This unit is equipped with an easy to see Graphical User Interface that uses menu displays and features colorful icons and easy to understand controls for maximum ease of use.



Part names and functions

Front panel

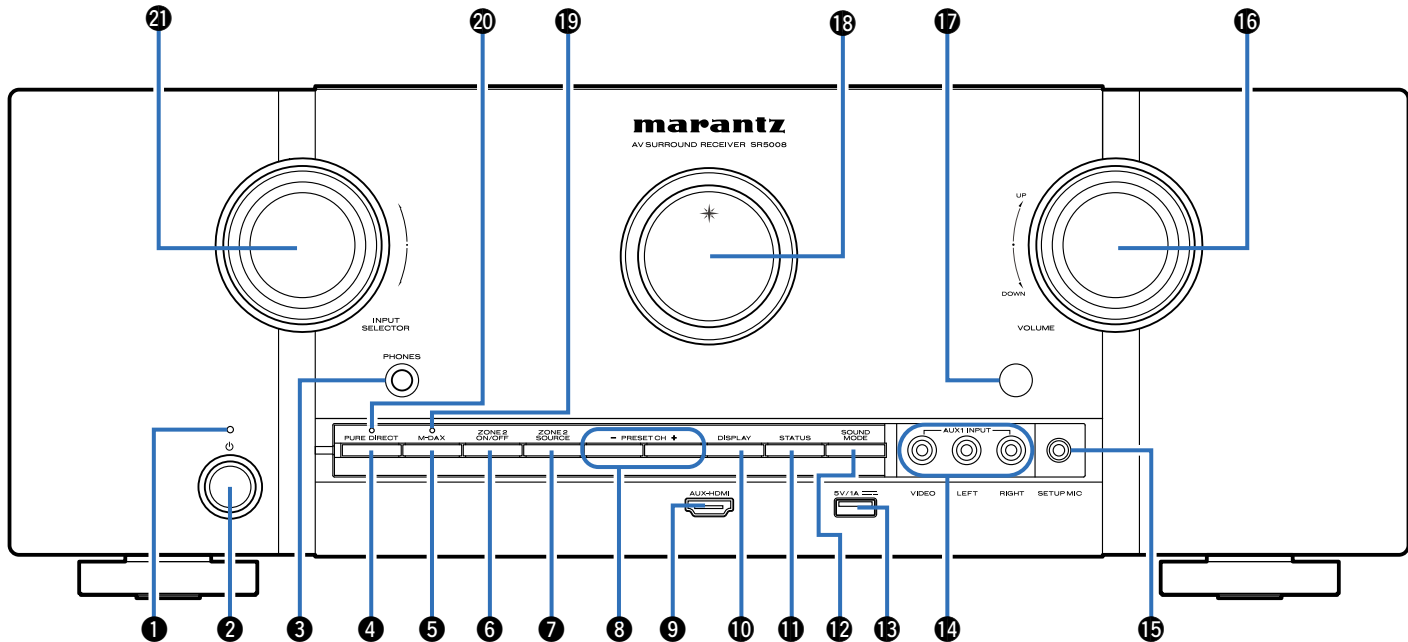

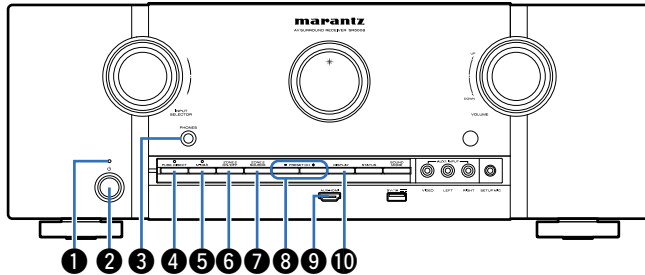

1 Power indicator

This is lit as follows according to the power status:

- Power on : Off
- Normal standby : Red
- When “HDMI Pass Through” ([page 150](#)) or “HDMI Control” ([page 150](#)) is set to “On” : Orange
- When “IP Control” ([page 173](#)) is set to “Always On” : Orange

2 Power operation button (⏻)

This turns the power of MAIN ZONE on/off (standby) ([page 52](#)).

3 Headphones jack (PHONES)

When the headphones are plugged into this jack, audio will no longer be output from the connected speakers or from the PRE OUT connectors.

NOTE

- To prevent hearing loss, do not raise the volume level excessively when using headphones.

4 PURE DIRECT button

This switches the sound mode between DIRECT, PURE DIRECT and AUTO ([page 109](#)).

5 M-DAX button

This enables the M-DAX mode ([page 143](#)).

6 ZONE2 ON/OFF button

This turns the power of ZONE2 on/off ([page 129](#)).

7 ZONE2 SOURCE button

This selects the input source for ZONE2 ([page 129](#)).

8 Tuner preset channel buttons (PRESET CH +, -)

These select preset FM/AM radio stations ([page 64](#)).

9 AUX-HDMI connector

Used to connect devices such as video cameras and game consoles ([page 39](#)).

10 DISPLAY button

This displays various pieces of information ([page 179](#)).



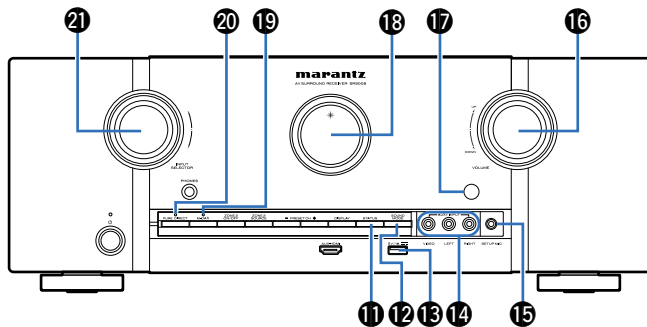

11 STATUS button

Each press of this switches the status information that is shown on the display (☞ [page 56](#)).

12 SOUND MODE button

This switches the sound mode (☞ [page 108](#)).

13 USB port

Used to connect USB storages (such as USB memory devices) and the USB cable supplied with iPod (☞ [page 41](#)).

14 AUX1 INPUT connectors

Used to connect devices such as a video camcorder or game console (☞ [page 39](#)).

Remove the cap covering the connectors when you want to use them.

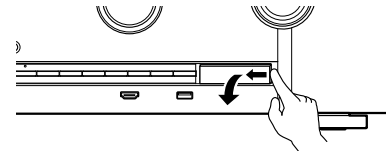

15 SETUP MIC jack

Used to connect the supplied Setup and measurement microphone (☞ [page 161](#)).

16 VOLUME knob

This adjusts the volume level (☞ [page 53](#)).

17 Remote control sensor

This receives signals from the remote control unit (☞ [page 8](#)).

18 Display

This displays various pieces of information (☞ [page 14](#)).

19 M-DAX indicator

This lights when the M-DAX mode is selected (☞ [page 143](#)).

20 PURE DIRECT indicator

This lights when the PURE DIRECT mode is selected as the sound mode (☞ [page 109](#)).

21 INPUT SELECTOR knob

This selects the input source (☞ [page 52](#)).



Display

The input source name, sound mode, setting values and other information are displayed here.

■ Standard display

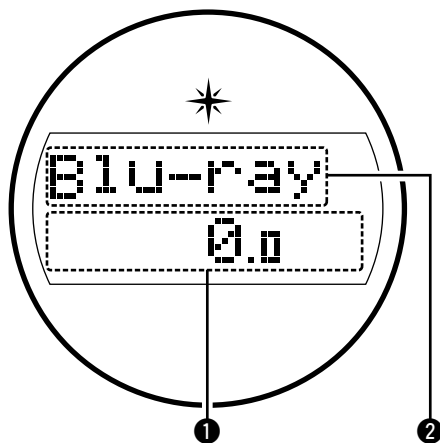

① Master volume indicator

② Input source indicator

The currently selected input source name is displayed.

If the input source name has been changed using "Source Rename" (see page 156) in the menu, the input source name after the change is displayed.

■ Tuner display

These light according to the reception conditions when the input source is set to "TUNER".

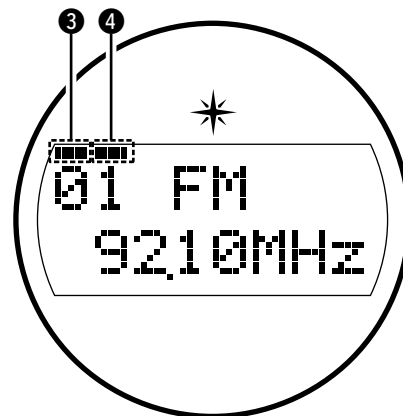

③ Lights up when the broadcast is properly turned in.

④ In the FM mode, this lights up when receiving stereo broadcasts.

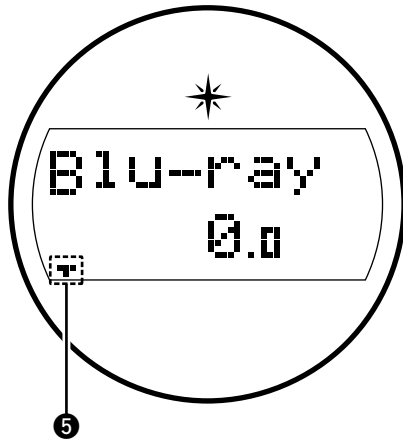

■ Sleep timer display

5 This lights when the sleep mode is selected (👉 [page 120](#)).

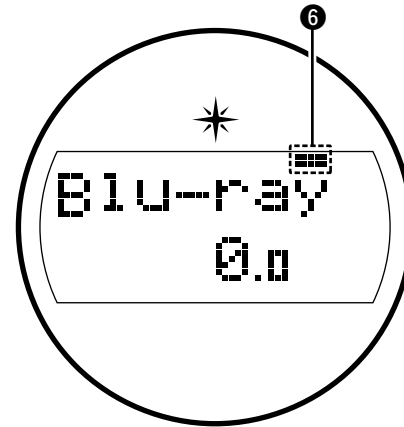
■ ZONE2 power on display

6 This lights up when ZONE2 (separate room) power is turned on (👉 [page 129](#)).



Rear panel

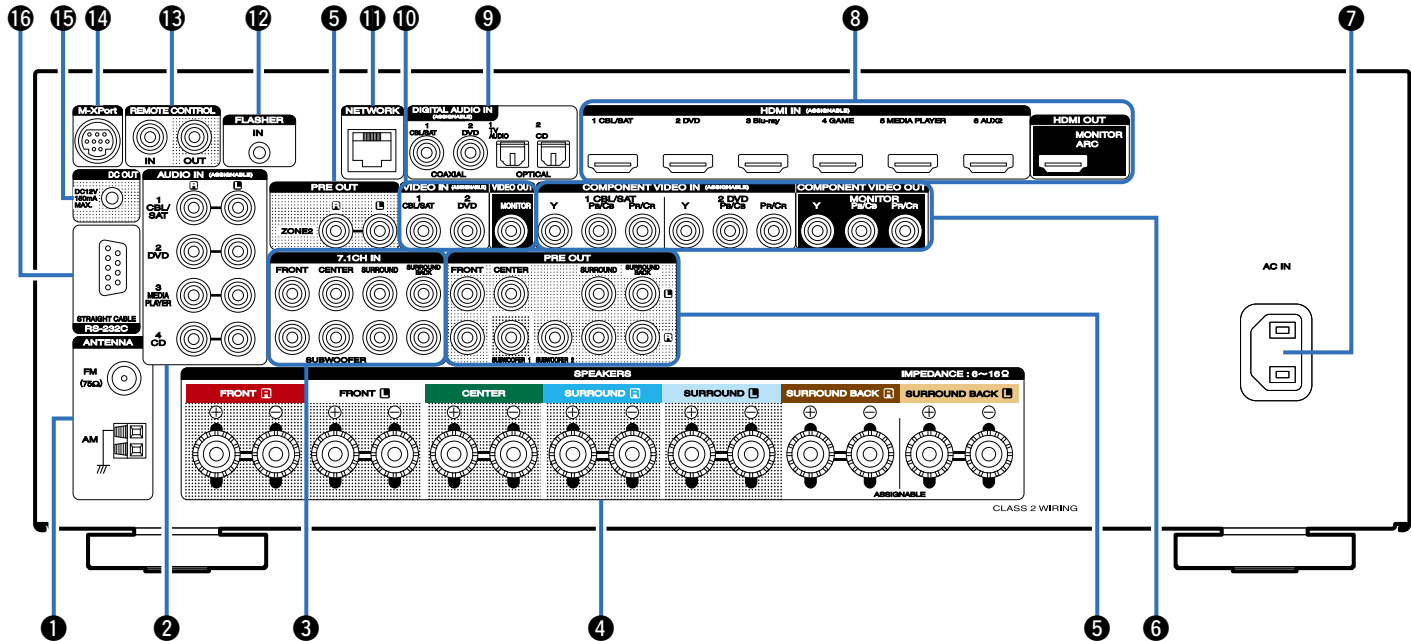

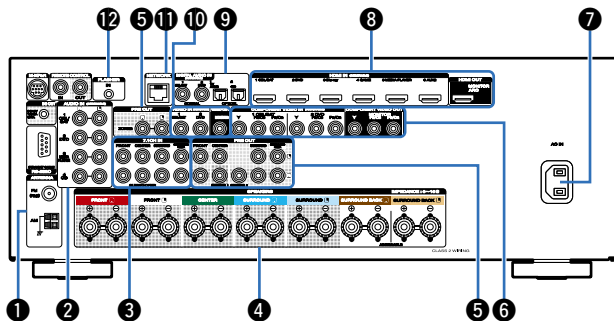

1 FM/AM antenna terminals (ANTENNA)

Used to connect FM and AM antennas ([page 43](#)).

2 Analog audio connectors (AUDIO)

Used to connect devices equipped with analog audio connectors ([page 37, 38, 39](#)).

3 7.1-channel input connectors (7.1CH IN)

Used to connect to a device that has multi-channel audio output connectors ([page 40](#)).

4 Speaker terminals (SPEAKERS)

Used to connect speakers ([page 25](#)).

5 PRE OUT connectors

Used to connect a subwoofer with a built-in amplifier or an external power amplifier ([page 26, 128](#)).

6 Component video connectors (COMPONENT VIDEO)

Used to connect devices equipped with component video connectors ([page 35, 37, 38](#)).

7 AC inlet (AC IN)

Used to connect the power cord ([page 50](#)).

8 HDMI connectors

Used to connect devices equipped with HDMI connectors ([page 33, 34, 37, 38](#)).

9 Digital audio connectors (DIGITAL AUDIO)

Used to connect devices equipped with digital audio connectors ([page 34, 35, 37, 38](#)).

10 Video connectors (VIDEO)

Used to connect devices equipped with video connectors ([page 35, 37, 38](#)).

11 Network connector (NETWORK)

Used to connect this unit to the network ([page 45](#)).

12 FLASHER IN jack

Used when using a control BOX or other such control devices to control this unit.



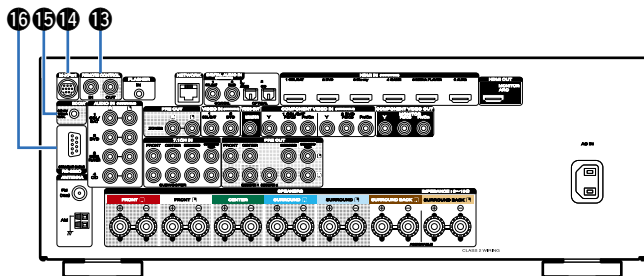

13 REMOTE CONTROL connectors

Used to connect infrared receivers/transmitters in order to operate this unit and external devices from a different room (☞ page 48).

14 M-XPoRT connector

Used to connect to a wireless receiver (RX101, sold separately) (☞ page 47).

15 DC OUT jack

Used to connect devices equipped with the trigger function (☞ page 49).

16 RS-232C connector

The RS-232C serial port is provided to allow compatibility with an external home automation controller. Consult the owner's manual of the home automation controller for more information about serial control of this unit. The serial port allows two-way control and status via an external home automation controller.

NOTE

- Do not touch the inner pins of the connectors on the rear panel. Electrostatic discharge may cause permanent damage to the unit.



Remote control unit

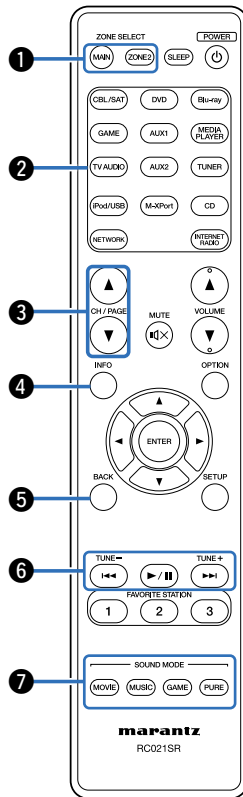

1 ZONE SELECT buttons (MAIN, ZONE2)

These switch the zone (MAIN ZONE, ZONE2) that is operated through the remote control unit (☞ [page 129, 137](#)).

2 Input source select buttons

These select the input source (☞ [page 52](#)).

3 Channel/page search buttons (CH/PAGE ▲▼)

These select preset radio stations or switch pages (☞ [page 64](#)).

4 Information button (INFO)

This displays the status information on the TV screen (☞ [page 180](#)).

5 BACK button

This returns to the previous screen (☞ [page 137](#)).

6 System buttons

These perform playback related operations (☞ [page 54](#)).

- Skip buttons (◀◀, ▶▶)
- Play/pause button (▶/||)

Tuning up / Tuning down buttons (TUNE +, -)

These operate the tuner (☞ [page 62](#)).

7 SOUND MODE buttons

These select the sound mode (☞ [page 107](#)).

- MOVIE button
- MUSIC button
- GAME button
- PURE button

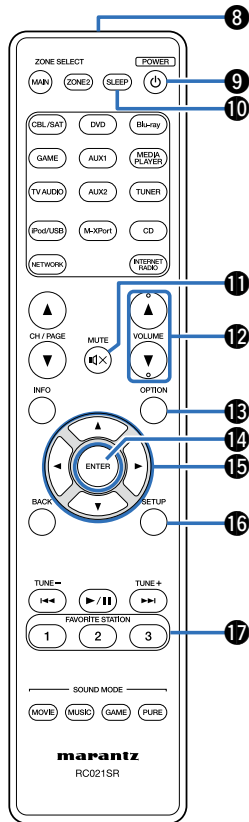

**8 Remote control signal transmitter**

This transmits signals from the remote control unit (☞ page 8).

9 POWER button (⏻)

This turns the power on/off (☞ page 52).

10 SLEEP button

This sets the sleep timer (☞ page 120).

11 MUTE button (🔇)

This mutes the output audio (☞ page 53, 130).

12 VOLUME buttons (▲▼)

These adjust the volume level (☞ page 53, 129).

13 OPTION button

This displays the option menu on the TV screen (☞ page 99).

14 ENTER button

This determines the selection (☞ page 137).

15 Cursor buttons (▲▼◀▶)

These select items (☞ page 137).

16 SETUP button

This displays the menu on the TV screen (☞ page 137).

17 FAVORITE STATION buttons (1 – 3)

With a single press of these, you can call up registered radio stations and contents (☞ page 94).



Connections

Speaker connection (👉 page 22)

Connecting a TV (👉 page 32)

Connecting a playback device (👉 page 36)

Connecting an iPod or USB memory device to the USB port (👉 page 41)

Connecting an FM/AM antenna (👉 page 43)

Connecting to a home network (LAN) (👉 page 45)

Connecting a wireless receiver (RX101) (👉 page 47)

Connecting an external control device (👉 page 48)

Connecting the power cord (👉 page 50)

NOTE

- Do not plug in the power cord until all connections have been completed. However, when the "Setup Assistant" is running, follow the instructions in the "Setup Assistant" (📖 page 7) screen for making connections. (During "Setup Assistant" operation, the input/output connectors do not conduct current.)
- Do not bundle power cords together with connection cables. Doing so can result in noise.

■ Cables used for connections

Provide necessary cables according to the devices you want to connect.

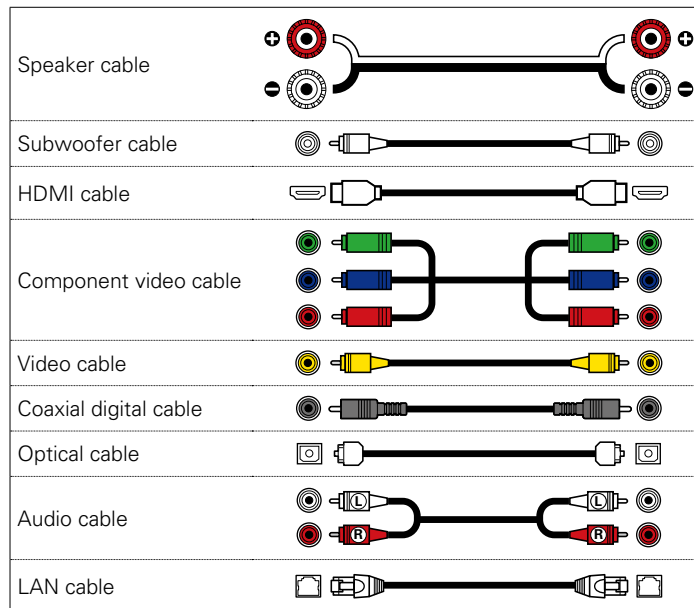

Speaker connection

Install speakers and connect them to this unit (☞ page 22, 25).

Speaker installation

Determine the speaker system depending on the number of speakers you are using and install each speaker and subwoofer in the room. Here, we explain how to install the speakers using a typical example.

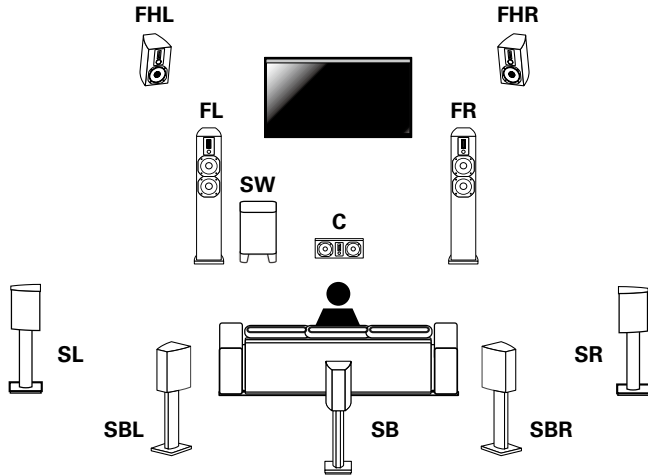

FL/FR : Place the FRONT left and right speakers an equal distance from the main listening position. The distance between each speaker and your TV should also be the same.

C : Place the CENTER speaker in between the front speakers and above or below your TV.

SL/SR : Place the SURROUND left and right speakers an equal distance to the left and right sides of the main listening position. If you don't have Surround Back speakers, move the surround speakers slightly behind your listening position.

SBL/SBR (SB) : Place the SURROUND BACK left and right speakers an equal distance from the main listening position and directly behind the main listening position. If you only have one Surround Back speaker, center it.

FHL/FHR : Place the FRONT HEIGHT left and right speakers just outside of the front left and right speakers. Mount them as close to the ceiling as possible and aim them towards the main listening position.

SW : Place the SUBWOOFER at a convenient location near the front speakers.





- This unit is compatible with Dolby Pro Logic IIz (see page 218) which offers an even wider and deeper surround sensation. When using Dolby Pro Logic IIz, install front height speakers.
- Use the illustration below as a guide for how high each speaker should be installed. The height does not need to be exactly the same.

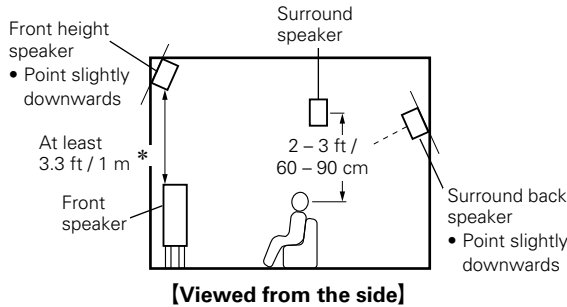

* Recommended for Dolby Pro Logic IIz

NOTE

- You cannot have audio output from the surround back speakers and front height speakers simultaneously.

■ When 7.1/6.1-channel speakers are installed using surround back speakers

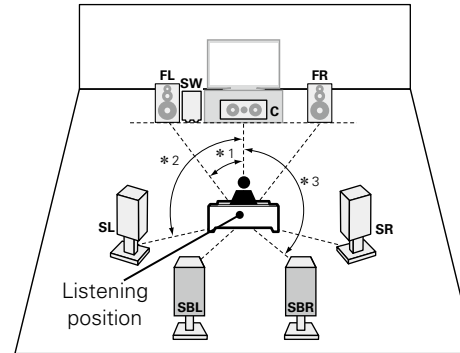

- *1 22° - 30°
- *2 90° - 110°
- *3 135° - 150°



- When using a single surround back speaker, place it directly behind the listening position.

[Speaker abbreviations]

FL	Front speaker (L)	SBL	Surround back speaker (L)
FR	Front speaker (R)	SBR	Surround back speaker (R)
C	Center speaker	FHL	Front height speaker (L)
SW	Subwoofer	FHR	Front height speaker (R)
SL	Surround speaker (L)		
SR	Surround speaker (R)		



■ When 7.1-channel speakers are installed using front height speakers

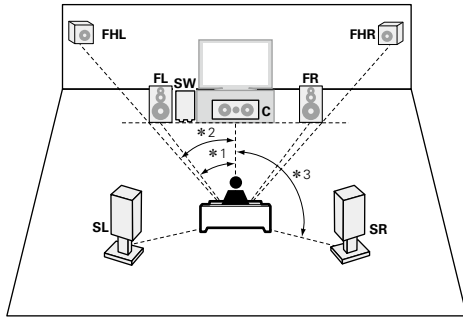

- *1 22° - 30°
- *2 22° - 45°
- *3 90° - 110°

■ When 5.1-channel speakers are installed

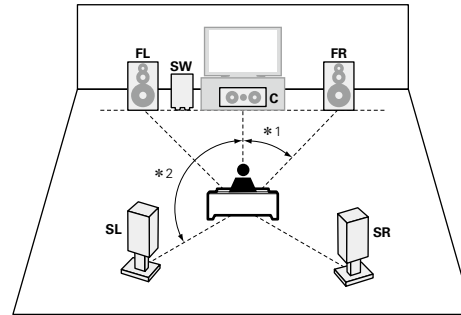

- *1 22° - 30°
- *2 120°



Speaker connection

Here we connect the speakers in the room to this unit.
This section explains how to connect them using typical examples.

NOTE

- Disconnect this unit's power plug from the power outlet before connecting the speakers. Also, turn off the subwoofer.
- Connect so that the speaker cable core wires do not protrude from the speaker terminal. The protection circuit may be activated if the core wires touch the rear panel or if the + and – sides touch each other (see page 221 "Protection circuit").
- Never touch the speaker terminals while the power cord is connected. Doing so could result in electric shock. When the "Setup Assistant" is running, follow the instructions in the "Setup Assistant" screen for making connections. (Power is not supplied to the speaker terminals while the "Setup Assistant" is running.)
- Use speakers with an impedance of 6 – 16 Ω /ohms.

■ Connecting the speaker cables

Carefully check the left (L) and right (R) channels and + (red) and – (black) polarities on the speakers being connected to this unit, and be sure to connect the channels and polarities correctly.

1 Peel off about 3/8 inch (10 mm) of sheathing from the tip of the speaker cable, then either twist the core wire tightly or terminate it.



2 Turn the speaker terminal counterclockwise to loosen it.

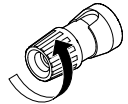

3 Insert the speaker cable's core wire to the hilt into the speaker terminal.

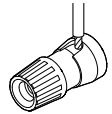

4 Turn the speaker terminal clockwise to tighten it.

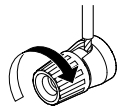

■ Connecting the subwoofer

Use a subwoofer cable to connect the subwoofer.

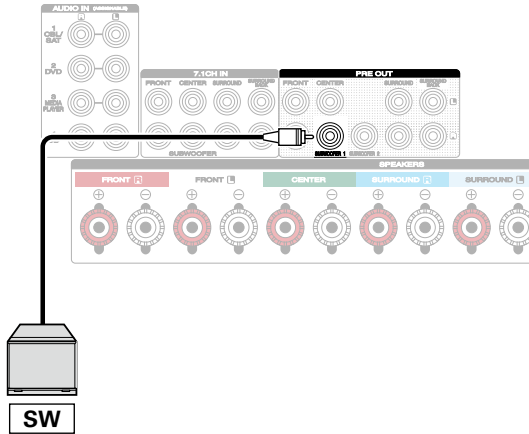

■ About the speaker cable label (supplied) for channel identification

The channel display section for speaker terminals on the rear panel is color-coded for each channel to be identifiable.

Speaker terminals	Color
FRONT L	White
FRONT R	Red
CENTER	Green
SURROUND L	Light blue
SURROUND R	Blue
SURROUND BACK L	Beige
SURROUND BACK R	Brown

Attach the speaker cable label for each channel to its speaker cable as shown in the diagram.

Then, make connection so that the color of the speaker terminal matches that of the speaker cable label.

[How to attach the speaker cable label]

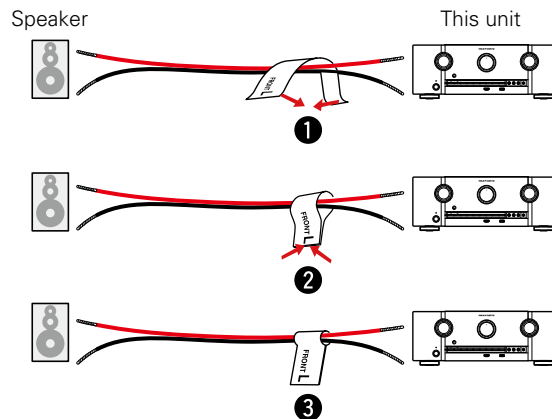

■ Connecting 7.1-channel speakers using surround back speakers

The illustrations shows a connection example for performing 7.1-channel playback using surround back speakers.

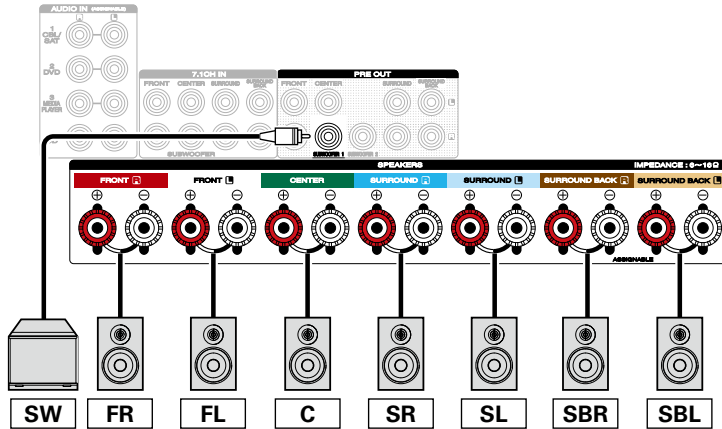

- When using this connection, also set "Assign Mode" in the menu to "Surround Back" (refer to [page 167](#)).
- When using a single surround back speaker, connect it to the SURROUND BACK L terminal.



■ About the front height or front B speaker connections

The speaker connected to the SURROUND BACK terminal differs depending on the mode selected for “Assign Mode” (☞ page 167) in the menu.

- For how to connect the front, center, and surround speaker and the subwoofer to this unit, see “Connecting 7.1-channel speakers using surround back speakers” (☞ page 28).

[Connecting the front height speaker]

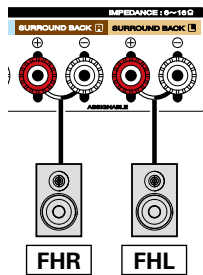

- When using this connection, also set “Assign Mode” in the menu to “Front Height” (☞ page 167).

[Connecting the front B speaker]

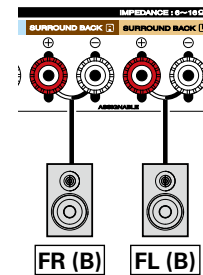

- When using this connection, also set “Assign Mode” in the menu to “Front B” (☞ page 167).



■ About the Bi-amp connection

Some audiophile loudspeakers can be connected to an amplifier with two separate amp-to-speaker connections per each speaker. One amplifier channel's output is hooked up to the speaker's bass driver (woofer), while the other amplifier drives the upper range transducers (tweeter, or in some cases midrange and tweeter). This connection method has one amplifier channel driving one half of the bi-amp speaker, and avoids electrical interference between the speaker's bass and treble drivers and the driving amplifier channels. You can assign 4 amp channels to connect to one pair of bi-amp capable speakers. Bi-amp capable speakers always have two sets of speaker input connector pairs, one for the bass range and one for the treble range. If you're unsure about whether or not your speakers are bi-amp capable, consult the owner's manual that came with the speakers.

- For how to connect the center, and surround speaker and the subwoofer to this unit, see "Connecting 7.1-channel speakers using surround back speakers" ([page 28](#)).

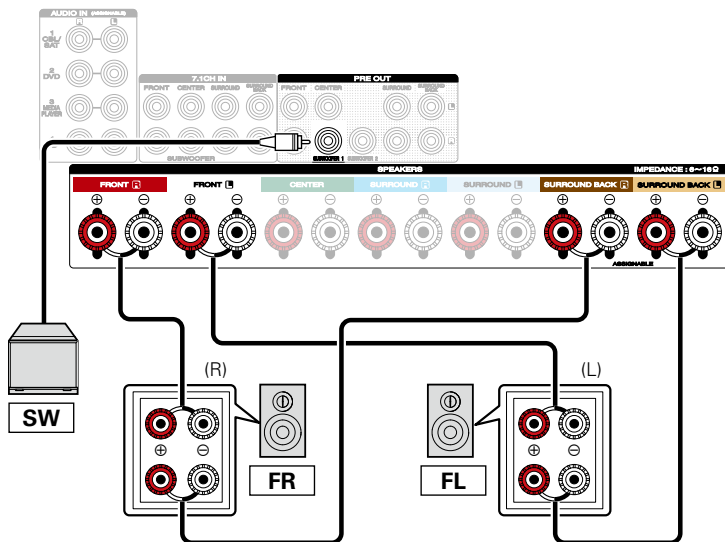

- When using this connection, also set "Assign Mode" in the menu to "Bi-AMP" ([page 167](#)).

NOTE

- When making bi-amp connections, be sure to remove the short-circuiting plate or wire between the speaker's woofer and tweeter terminals.



■ Connecting an external power amplifier

- You can use this unit as a pre-amp by connecting an external power amplifier to the PRE OUT connectors. Adding an external power amplifier with a higher power output rating than this unit may be beneficial with loudspeakers that have lower efficiency and/or lower impedances, or to reach higher volume levels.
- Select the terminal to use and connect the device.

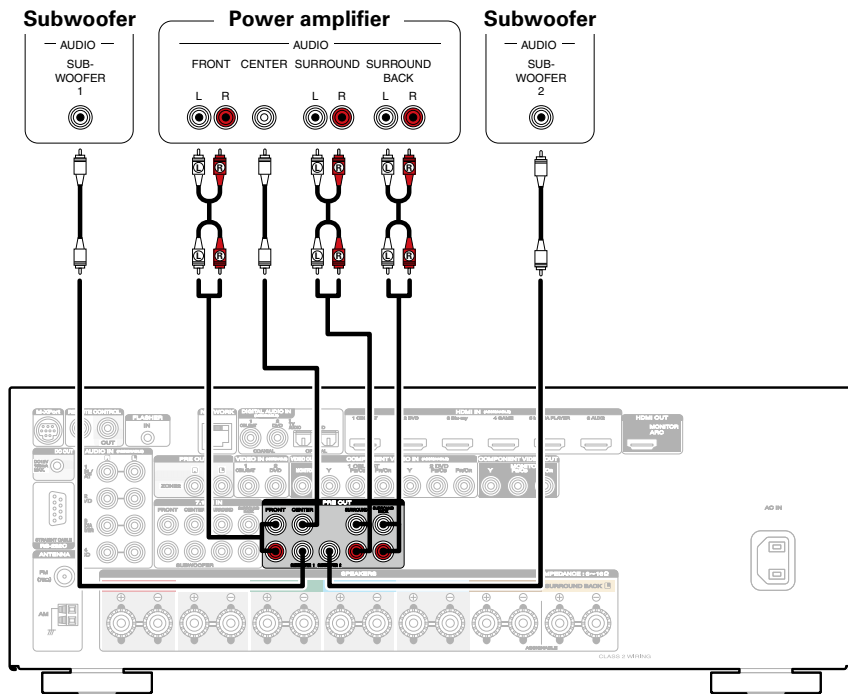

- When using just one surround back speaker, connect it to the left channel (L) terminal.



Connecting a TV

Connect a TV to this unit so that the input video is output to the TV. You can also enjoy audio from the TV on this unit.

How to connect a TV depends on the connectors and functions equipped on the TV.

ARC function plays TV audio on this unit by sending the TV audio signal to this unit via HDMI cable.

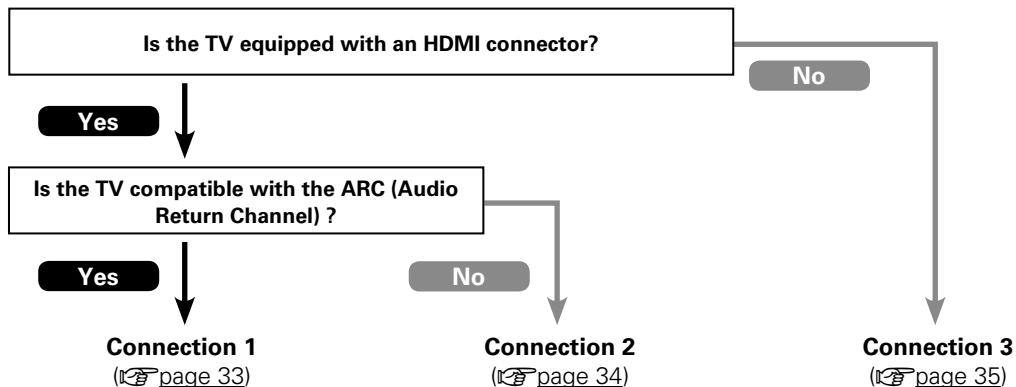

Connection 2 : TV equipped with an HDMI connector

Use an HDMI cable to connect the TV to this unit.

To listen to audio from TV on this unit, use an optical cable to connect the TV to this unit.

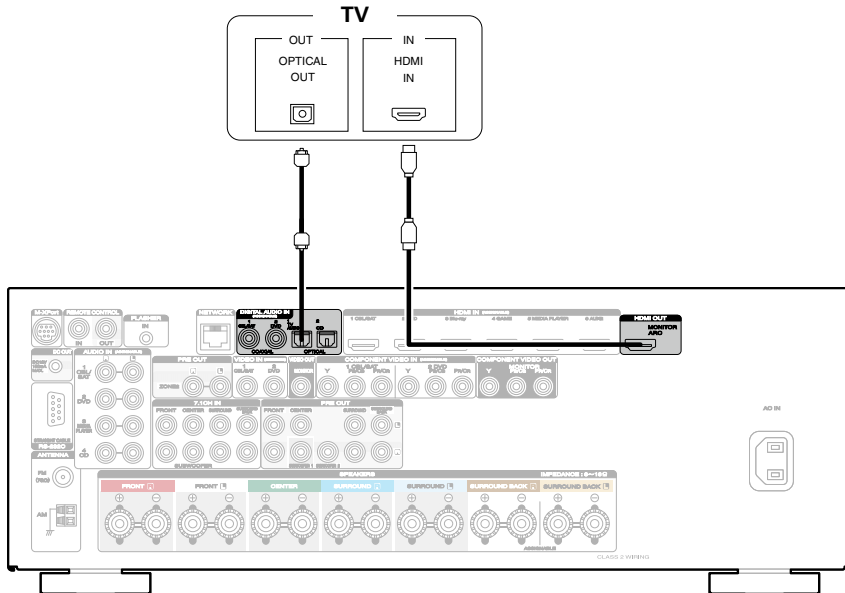

- To output audio signals that are input from the HDMI input connector to a TV connected via HDMI, set "HDMI Audio Out" (see [page 149](#)) to "TV".



Connection 3 : TV equipped without an HDMI connector

Use a video or a component cable to connect the TV to this unit.

To listen to audio from TV on this unit, use an optical cable to connect the TV to this unit.

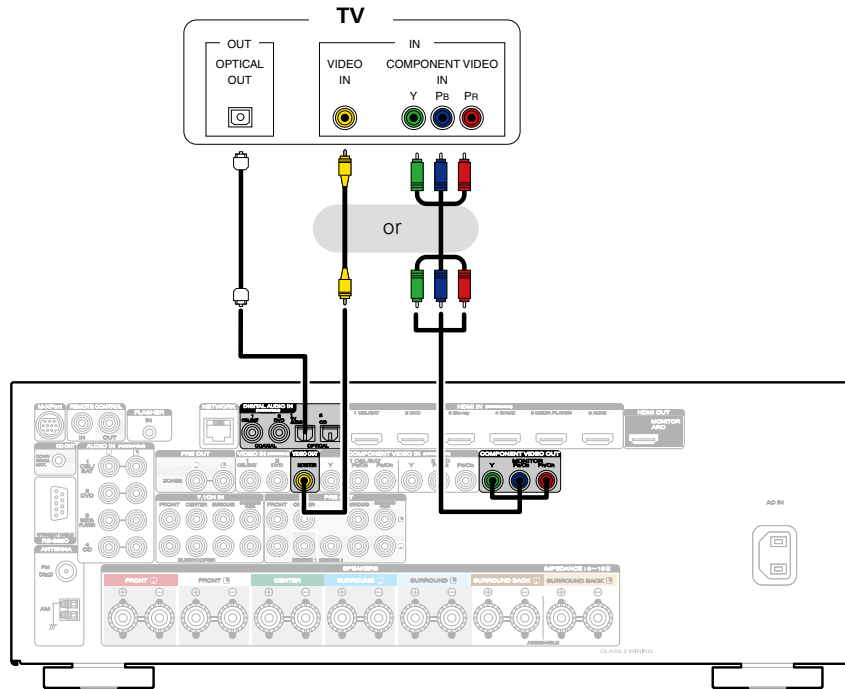





Connecting a playback device

This unit is equipped with three types of video input connectors (HDMI, component video and composite video) and three types of video output connectors (HDMI, component video and composite video).

Select input connectors on this unit according to the connectors equipped on the device you want to connect.

If the device connected to this unit is equipped with an HDMI connector, it is recommended to use HDMI connections.

In the HDMI connection, audio and video signals can be transmitted through a single HDMI cable.

- Connecting a set-top box (Satellite tuner/cable TV) ( [page 37](#))
- Connecting a DVD player ( [page 38](#))
- Connecting a video camcorder or other device ( [page 39](#))
- Connecting a device with a multi-channel output connector ( [page 40](#))



- Connect devices to this unit as indicated by the input sources printed on the audio/video input connectors of this unit.
- This unit can change the source that is assigned to the HDMI IN, DIGITAL AUDIO IN, COMPONENT VIDEO IN, VIDEO IN and AUDIO IN connectors.
How to change the source assigned to connectors ( [page 154](#) "Input Assign").



Connecting a set-top box (Satellite tuner/cable TV)

This explanation uses the connection with a satellite tuner/cable TV STB as an example.

Select input connectors on this unit according to the connectors equipped on the device you want to connect.

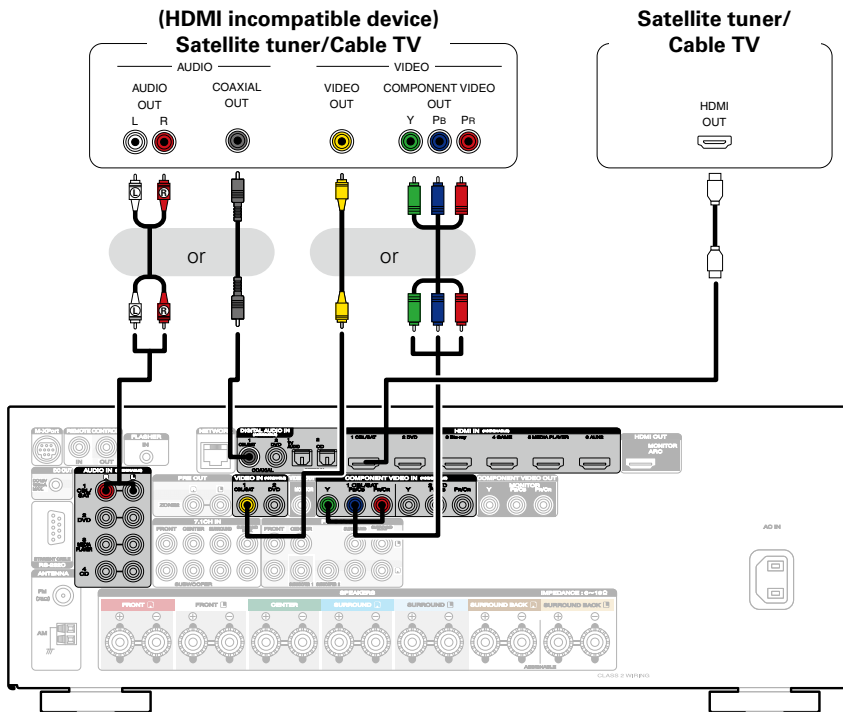

Connecting a video camcorder or other device

Connect a playback device to this unit, such as a video camcorder or game console.

This explanation uses the connection with a video camcorders as an example.

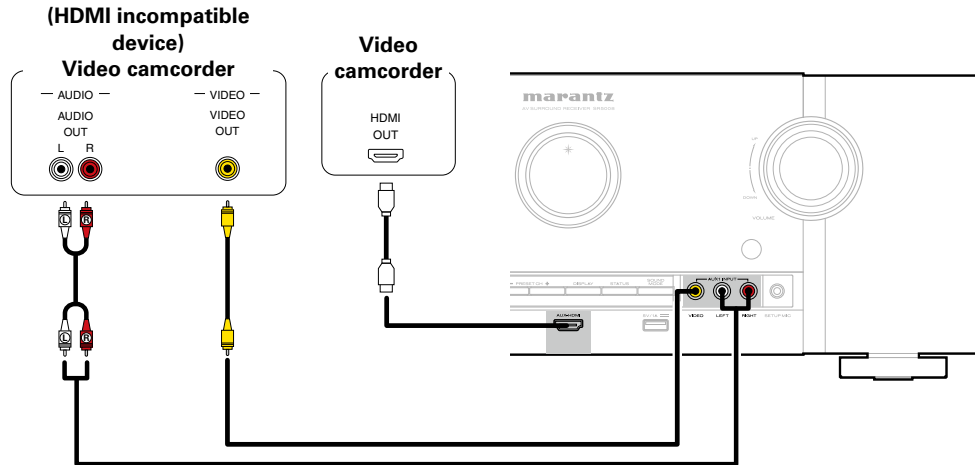

Connecting a device with a multi-channel output connector

You can connect this unit to an external device fitted with multi-channel sound audio output connectors to enjoy music and video. To play analog signals input from 7.1CH IN connectors, set "Input Mode" (☞ [page 157](#)) to "7.1CH IN".

Devices with a multi-channel output connector (Blu-ray Disc player, DVD player, External decoder etc.)

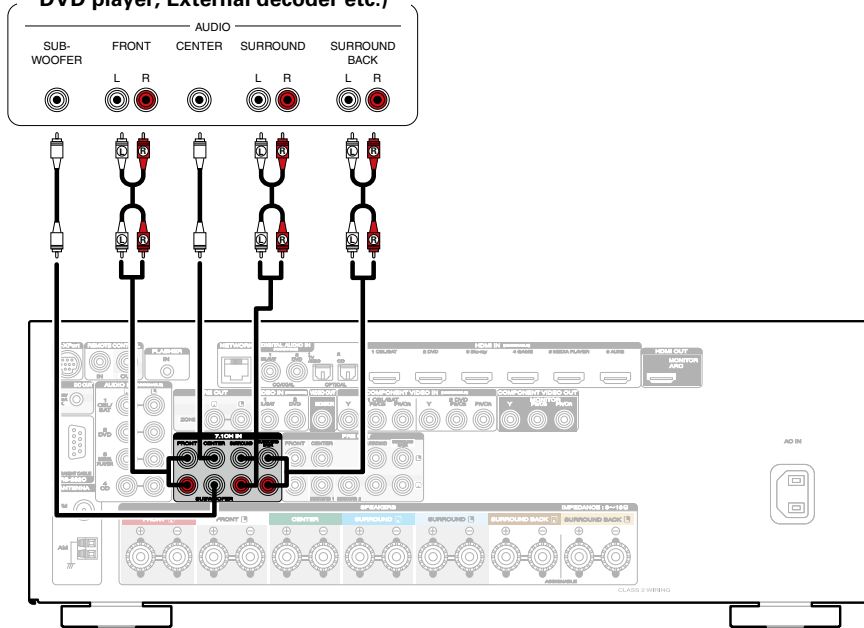

- The video signal can be connected in the same way as a DVD player (☞ [page 38](#) "Connecting a DVD player").
- When a device is connected to the SBL/SBR terminal of 7.1CH IN connectors, set "Assign Mode" (☞ [page 167](#)) to "Surround Back".



Connecting an iPod or USB memory device to the USB port

To connect an iPod to this unit, use the USB adapter cable that was supplied with the iPod.

For operating instructions see “Playing an iPod” (page 54) or “Playing a USB memory device” (page 58).

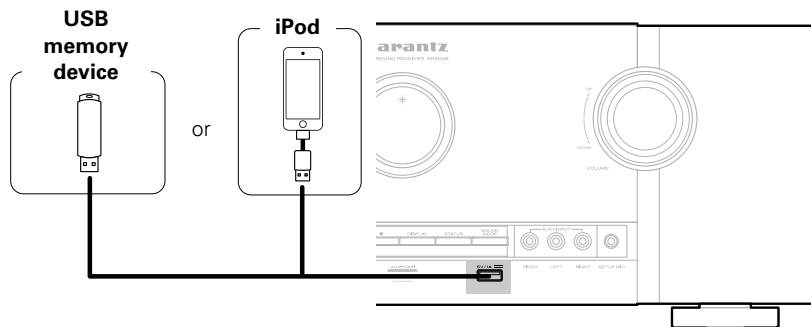

- Marantz does not guarantee that all USB memory devices will operate or receive power. When using a portable USB hard disk drive (HDD) which came with an AC adapter, use that device's supplied AC adapter.

NOTE

- USB memory devices will not work via a USB hub.
- It is not possible to use this unit by connecting the unit's USB port to a PC via a USB cable.
- Do not use an extension cable when connecting a USB memory device. This may cause radio interference with other devices.



■ Supported iPod/iPhone models

• iPod classic



iPod classic
80GB



iPod classic
160GB (2007)



iPod classic
160GB (2009)

• iPod nano



iPod nano
3rd generation
(video)
4GB 8GB



iPod nano
4th generation (video)
8GB 16GB



iPod nano
5th generation (video camera)
8GB 16GB



iPod nano
6th generation
8GB 16GB



iPod nano
7th generation
16GB

• iPod touch



iPod touch
1st generation
8GB 16GB 32GB



iPod touch
2nd generation
8GB 16GB 32GB



iPod touch
3rd generation
32GB 64GB



iPod touch
4th generation
8GB 32GB 64GB



iPod touch
5th generation
32GB 64GB

• iPhone



iPhone
4GB 8GB 16GB



iPhone 3G
8GB 16GB



iPhone 3GS
8GB 16GB 32GB



iPhone 4
8GB 16GB 32GB



iPhone 4S
16GB 32GB 64GB



iPhone 5
16GB 32GB 64GB



Connecting an FM/AM antenna

After connecting the antenna and receiving a broadcast signal (☞ page 62 “Listening to FM/AM broadcasts”), fix the antenna with tape in a position where the noise level becomes minimal.

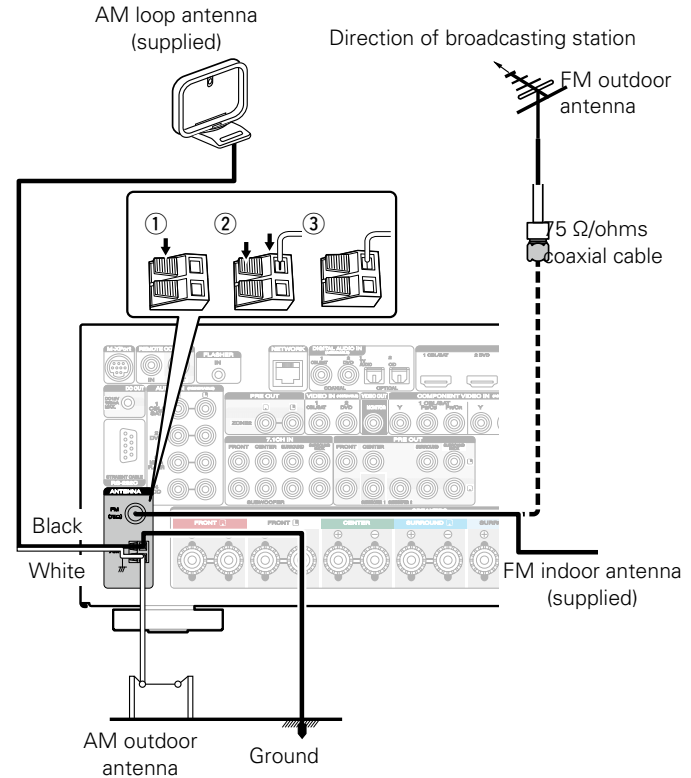

■ AM loop antenna assembly

- 1 Put the stand section through the bottom of the loop antenna from the rear and bend it forward.
- 2 Insert the projecting part into the square hole in the stand.

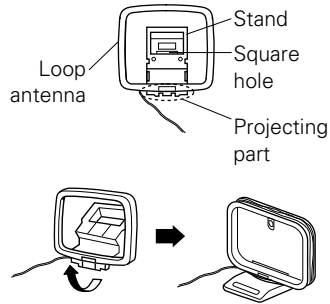

■ Using the AM loop antenna

Suspending on a wall

Suspend directly on a wall without assembling.

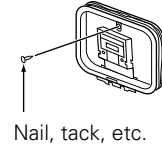

Standing alone

Use the procedure shown above to assemble.

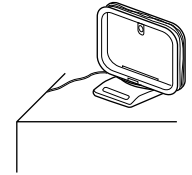

NOTE

- Do not connect two FM antennas simultaneously.
- Even if an external AM antenna is used, do not disconnect the AM loop antenna.
- Make sure the AM loop antenna lead terminals do not touch metal parts of the panel.
- If the signal has noise interference, connect the ground terminal (GND) to reduce noise.
- If you are unable to receive a good broadcast signal, we recommend installing an outdoor antenna. For details, inquire at the retail store where you purchased the unit.



Connecting to a home network (LAN)

You can connect this unit to your home network (LAN) to perform various types of playbacks and operations as follows.

- Playback of network audio such as Internet Radio and from your media server(s)
- Playback of music content from online streaming services
- Using the Apple AirPlay function
- Operation on this unit via the network
- Firmware Update



- With this unit, it is possible to use the DHCP and Auto IP functions to make the network settings automatically.
- When using this unit connected to a network with no DHCP function, make the settings for the IP address, etc., at "Network" (page 173).

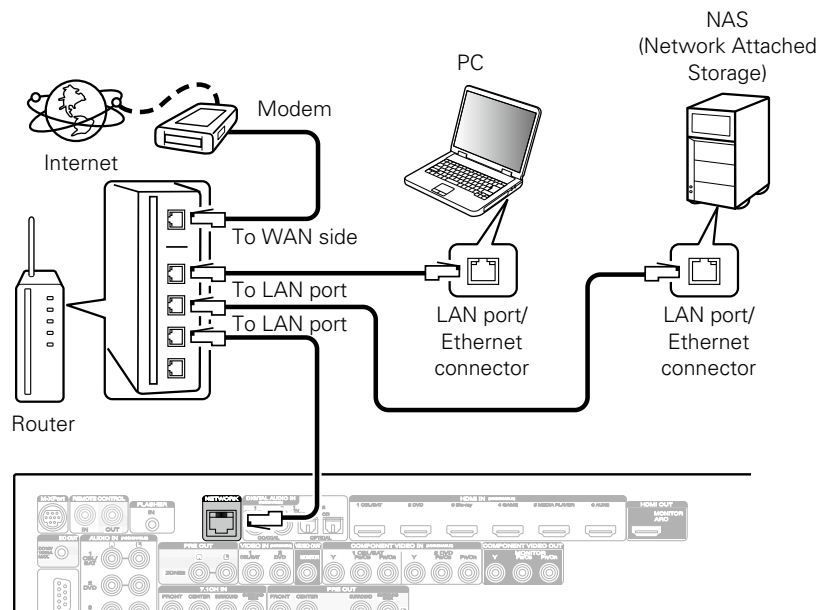

For connections to the Internet, contact an ISP (Internet Service Provider) or a computer shop.





- When using this unit, we recommend you use a router equipped with the following functions:
 - Built-in DHCP server
This function automatically assigns IP addresses on the LAN.
 - Built-in 100BASE-TX switch
When connecting multiple devices, we recommend a switching hub with a speed of 100 Mbps or greater.
- Use only a shielded STP or ScTP LAN cable which is easily available at electronics stores (CAT-5 or greater recommended).
- The normal shielded-type LAN cable is recommended. If a flat-type cable or unshielded-type cable is used, other devices could be affected by noise.

NOTE

- The types of routers that can be used depend on the ISP. Contact your ISP or a computer shop for details.
- This unit is not compatible with PPPoE. A PPPoE-compatible router is required if you have a contract for a type of line set by PPPoE.
- Do not connect an NETWORK connector directly to the LAN port/ Ethernet connector on your computer.



Connecting a wireless receiver (RX101)

You can connect a wireless receiver (RX101, sold separately) to play back music on your Bluetooth device with this unit.

To do this, switch the input source to “M-XPort” (see page 52 “Selecting the input source”).



- When connecting your Bluetooth device to the wireless receiver for the first time, pairing is necessary. Once pairing is completed, the communication between your Bluetooth device and the wireless receiver can be established just by connecting them. Pairing is necessary for each Bluetooth device.
- You can also use the wireless receiver as an IR receiver. In this case, disable the remote control signal receiving function (see page 126 “Remote lock function”).
- This unit supports the A2DP standard of the Bluetooth profile.

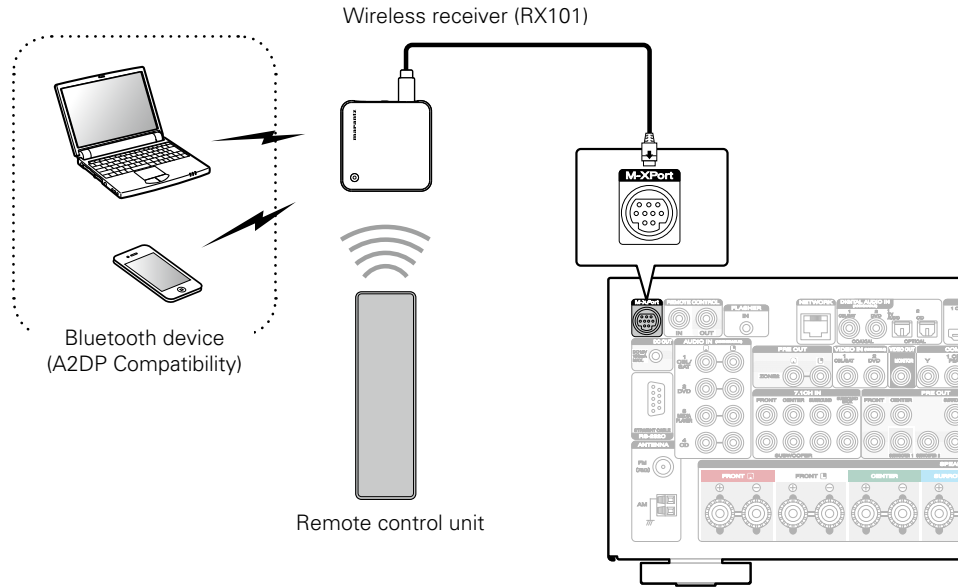

Connecting an external control device

Remotely connecting Marantz devices

■ Performing operations by RC on this unit without visual contact

You can connect an external IR receiver to the REMOTE CONTROL connectors to perform operations on this unit with the supplied remote control unit without visual contact. This might be necessary if the unit is hidden in a cupboard or corner, so you can't directly point with the remote control unit to the device.

To do this, disable the remote control signal receiving function (see page 126 "Remote lock function").

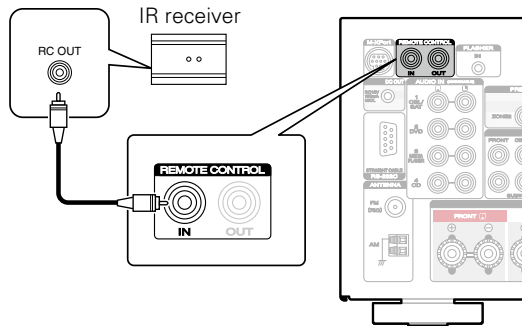

■ Remotely connecting Marantz devices

When you are using a Marantz device other than this unit that supports remote connection, you can transmit remote control signals just by connecting the device to the REMOTE CONTROL IN/OUT connector with a monaural cable.

Set the remote control switch located on the rear panel of the connected audio component to "EXTERNAL" or "EXT." to use this feature.

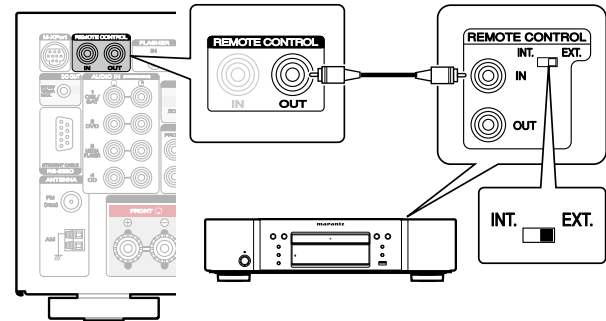

NOTE

- When the remote control signal receiving function is disabled, you can not perform operations with the remote control unit.



Remotely control a Marantz Blu-ray Disc player by the Marantz Remote App

Marantz Blu-ray Disc player of newer generation also can be controlled via a network receiver unit using the Marantz Remote App. Please ensure REMOTE CONTROL system of the receiver unit and the Blu-ray Disc player is set up as shown in the previous section.

DC OUT jack

When a device with DC IN jack is connected, the connected device's power on/standby can be controlled through linked operation to this unit. The DC OUT jack outputs a maximum 12 V/150 mA electrical signal.

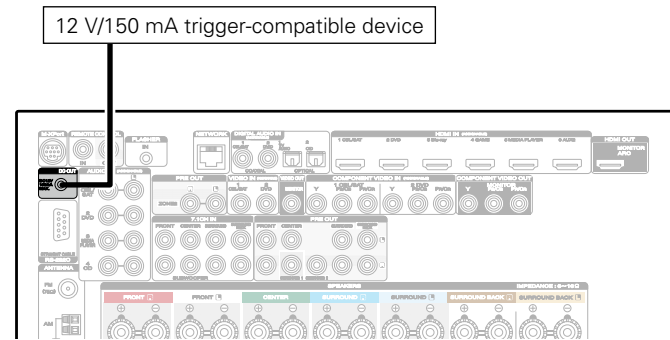

NOTE

- Use the monaural mini-plug cable for connecting DC OUT jacks. Do not use the stereo mini-plug cable.
- If the permissible trigger input level for the connected device is larger than 12 V/150 mA, or has shorted, the DC OUT jack cannot be used. In this case, turn off the power to the unit, and disconnect it.



Connecting the power cord

After completing all the connections, insert the power plug into the power outlet.

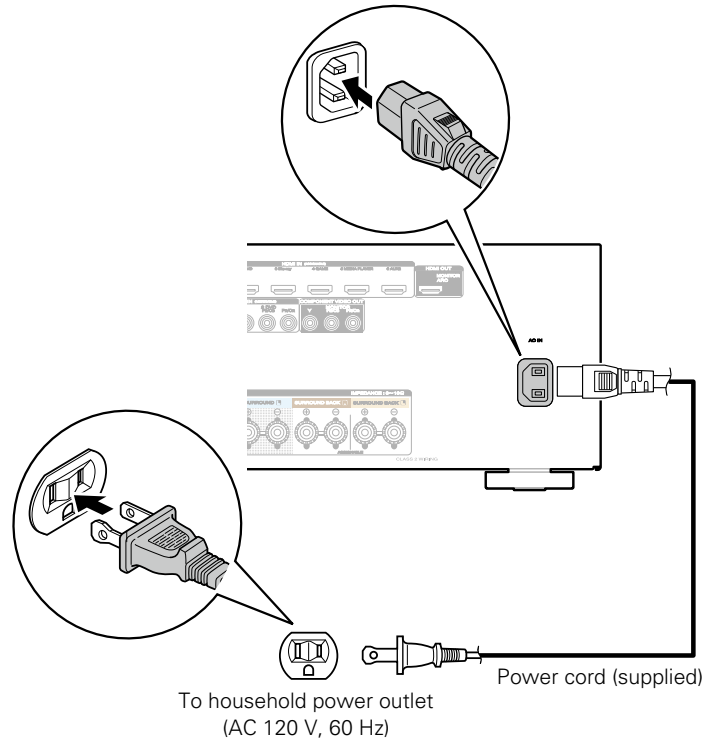

Playback

Turning the power on (🔗 page 52)

Selecting the input source (🔗 page 52)

Adjusting the master volume (🔗 page 53)

Turning off the sound temporarily (🔗 page 53)

Playing a DVD player/Blu-ray Disc player (🔗 page 53)

Playing an iPod (🔗 page 54)

Playing a USB memory device (🔗 page 58)

Listening to FM/AM broadcasts (🔗 page 61)

Listening to Internet Radio (🔗 page 68)

Playing back files stored on a PC and NAS (🔗 page 72)

Viewing photographs on the Flickr site (🔗 page 76)

Listening to Pandora® (🔗 page 80)

Listening to SiriusXM Internet Radio (🔗 page 87)

Listening to Spotify (🔗 page 90)

Adding to the FAVORITE STATION button (🔗 page 94)

AirPlay function (🔗 page 96)

Convenience functions (🔗 page 99)

Selecting a sound mode (🔗 page 107)

HDMI control function (🔗 page 119)

Sleep timer function (🔗 page 120)

Web control function (🔗 page 121)

Dual backup memory function (🔗 page 123)

Panel lock function (🔗 page 124)

Remote lock function (🔗 page 126)

Playback in ZONE2 (Separate room) (🔗 page 127)



Basic operation

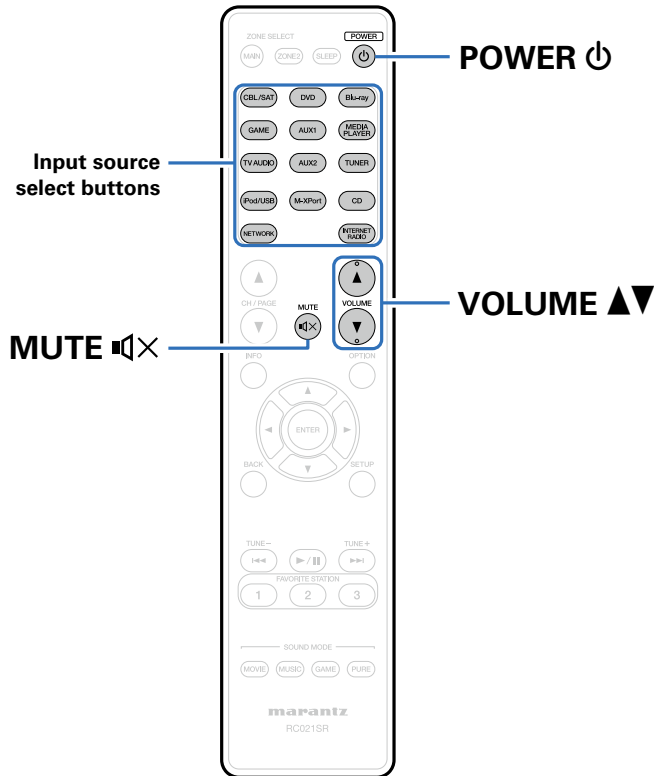

Turning the power on

1 Press POWER to turn on power to the unit.



- You can also switch the power to standby by pressing on the main unit.

Selecting the input source

1 Press the input source select button to be played back.
The desired input source can be selected directly.



- You can also select the input source by turning INPUT SELECTOR knob on the main unit.



Adjusting the master volume

- 1 Use **VOLUME ▲▼** to adjust the volume.
 - The variable range differs according to the input signal and channel level setting.





- You can also adjust the master volume by turning VOLUME on the main unit.

Turning off the sound temporarily

- 1 Press **MUTE** .

 - "MUTE" appears on the display.
 -  appears on the TV screen.



- The sound is reduced to the level set at "Mute Level" ( page 144).
- To cancel, press MUTE  again. Muting can also be cancelled by adjusting the master volume.

Playing a DVD player/Blu-ray Disc player

The following describes the procedure for playing DVD player/Blu-ray Disc player.

- 1 **Prepare for playback.**
 - ① Turn on the power of the TV, subwoofer and player.
 - ② Change the TV input to the input of this unit.
- 2 **Press POWER**  to turn on power to the unit.
- 3 **Press DVD or Blu-ray to switch an input source for a player used for playback.**
- 4 **Play the DVD player or Blu-ray Disc player.**



Playing an iPod

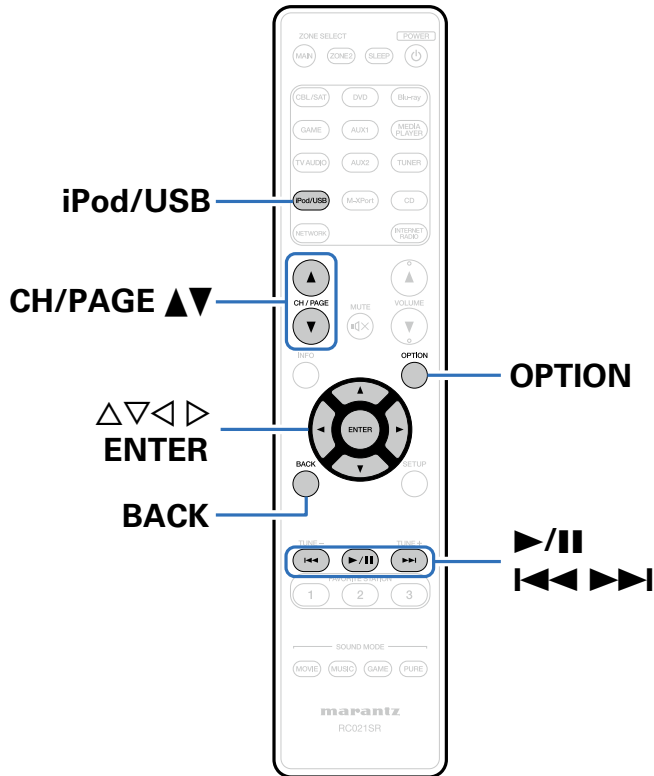

- You can use the USB cable provided with the iPod to connect the iPod with the unit's USB port and enjoy music stored on the iPod.
- For information on the iPod models that can be played back with this unit, see "Supported iPod/iPhone models" (👉 page 42).



Listening to music on an iPod

- 1 Connect the iPod to the USB port** (👉 [page 41](#)).
- 2 Press iPod/USB to switch the input source to “iPod/USB”.**

“Browse From iPod” is displayed on the display of this unit.

 - Nothing is displayed on the TV screen.
- 3 Operate iPod itself directly while seeing the iPod screen to play back music.**



- The iPod display modes include “From iPod” and “On-Screen”.
By default, “From iPod”, where you directly operate the iPod itself while looking at the iPod screen, is set.
- To change to “On-Screen”, where you perform operations while having the iPod information displayed on the TV screen, see “Setting operation mode (iPod Browse Mode)” (👉 [page 56](#)).

NOTE

- Depending on the type of iPod and the software version, some functions may not operate.
- Note that Marantz will accept no responsibility whatsoever for any problems arising with the data on an iPod when using this unit in conjunction with the iPod.

■ Playing the AirPlay (👉 [page 96](#))

- **Operations available through the OPTION button**
 - Setting operation mode (iPod Browse Mode) (👉 [page 56](#))



Setting operation mode (iPod Browse Mode)

In this mode, various lists and screens during playback on the iPod are displayed on the TV screen.

This section describes the steps up to playing back tracks on the iPod in "On-Screen".

1 Press OPTION.

The option menu screen is displayed.

2 Select "iPod Browse Mode", then press ENTER.

The "iPod Browse Mode" screen is displayed.

3 Use ◀▶ to select "On-Screen", then press ENTER.

- Operations available for "On-Screen" and "From iPod" are listed below.

Display mode		From iPod	On-Screen
Playable files	Music file	✓	✓
	Video file	*	
Active buttons	Remote control unit (This unit)	✓	✓
	iPod	✓	

* Only the sound is played.

4 Use ▲▼ to select the file to be played, then press ENTER.

Playback starts.

Operation buttons	Function
▶/	Playback / Pause
	Previous / Next
◀◀ ▶▶	(Press and hold) Fast-reverse / Fast-forward
	Playback / Pause
ENTER	(Press and hold) Stop
	Previous / Next
▲▼	(Press and hold) Fast-reverse / Fast-forward
CH/PAGE ▲▼	Page previous / Page next



- The display switches between track title, artist name, and album title etc. each time the STATUS button is pressed during playback with "iPod Browse Mode" set to "On-Screen".
- English letters, numbers and certain symbols are displayed. Incompatible characters are displayed as "." (period).

■ Operations available through the OPTION button

- Performing repeat playback (Repeat) (🔁 page 57)
- Performing random playback (Random) (🎲 page 57)



Performing repeat playback (Repeat)

- 1 Press **OPTION** with “iPod Browse Mode” set to “On-Screen”.

The option menu screen is displayed.

- 2 Use $\Delta \nabla$ to select “Repeat”, then press **ENTER**.

- 3 Use $\triangleleft \triangleright$ to select repeat playback mode.

Off (Default) : Repeat playback mode is canceled.

One : A file being played is played repeatedly.

All : All files in the folder currently being played are played repeatedly.

- 4 Press **ENTER**.

The display returns to the playback screen.

Performing random playback (Random)

- 1 Press **OPTION** with “iPod Browse Mode” set to “On-Screen”.

The option menu screen is displayed.

- 2 Use $\Delta \nabla$ to select “Random”, then press **ENTER**.

- 3 Use $\triangleleft \triangleright$ to select random playback mode.

Off (Default) : Disable random playback.

On : Randomly play back all tracks in the current playback folder.

- 4 Press **ENTER**.

The display returns to the playback screen.



- During random playback, each time playback of a track is completed, another track is randomly selected for playback from tracks in the folder. Therefore, it's possible that you may hear a track played back more than once during random playback.



Playing a USB memory device

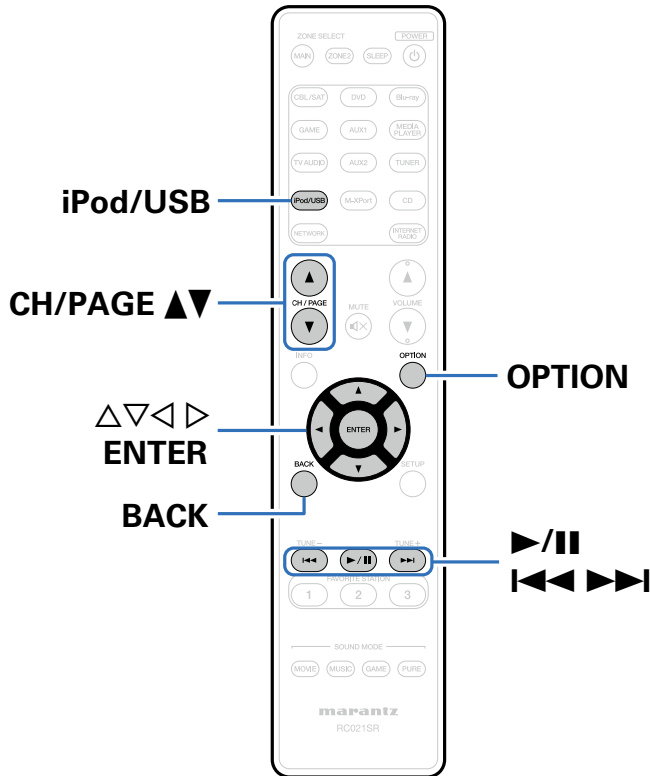

- Playing back music or viewing still picture (JPEG) files stored on a USB memory device.
- Only USB memory devices conforming to mass storage class and MTP (Media Transfer Protocol) standards can be played on this unit.
- This unit is compatible with USB memory devices in "FAT16" or "FAT32" format.
- This unit can play back the following files.
 - **WMA** (Windows Media Audio)
 - **MP3** (MPEG-1 Audio Layer-3)
 - **WAV**
 - **MPEG-4 AAC**
 - **FLAC** (Free Lossless Audio Codec)
 - **JPEG**
 - **ALAC** (Apple Lossless Audio Codec)



Playing files stored on USB memory devices

- 1 Connect the USB memory device to the USB port (🔌 page 41).
- 2 Press iPod/USB to switch the input source to “iPod/USB”.



- 3 Use $\Delta \nabla$ to select the file to be played, then press ENTER. Playback starts.

Operation buttons	Function
$\blacktriangleright / \parallel$	Playback / Pause
$\blacktriangleleft \blacktriangleright$	Previous / Next (Press and hold) Fast-reverse / Fast-forward*
ENTER	Playback / Pause (Press and hold) Stop
$\Delta \nabla$	Previous / Next (Press and hold) Fast-reverse / Fast-forward*
CH/PAGE $\blacktriangle \blacktriangledown$	Page previous / Page next

* This function is available while an MP3 / WAV / AAC / FLAC file is being played back.







- When an MP3 music file includes album art data, the album art can be displayed while playing the file.

NOTE

- Note that Marantz will accept no responsibility whatsoever for any problems arising with the data on a USB memory device when using this unit in conjunction with the USB memory device.



■ Operations available through the OPTION button

- Performing repeat playback (Repeat) ( page 100)
- Performing random playback (Random) ( page 100)
- Searching content with keywords (Text Search) ( page 102)
- Playing back still pictures in sequential order (Slideshow Interval) ( page 104)



Listening to FM/AM broadcasts

For antenna connections, see “Connecting an FM/AM antenna” (🔗 page 43).

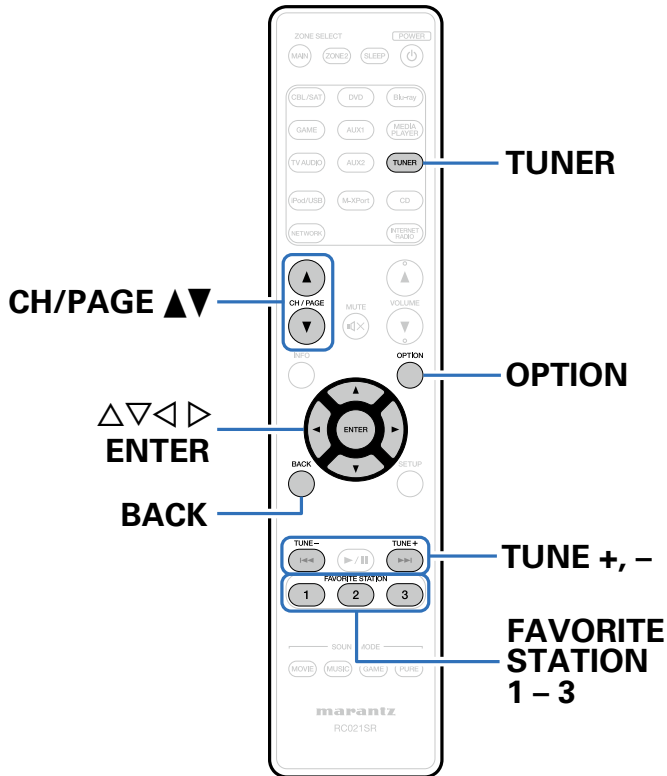

Listening to FM/AM broadcasts

- 1 Press **TUNER** to switch the input source to “TUNER”.

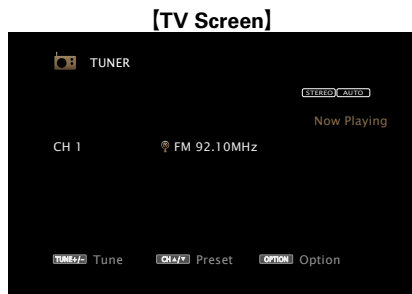

[Display of this unit]



- 2 Press **OPTION**.
The option menu screen is displayed.
- 3 Use **▲▼** to select “FM/AM”, then press **ENTER**.
- 4 Use **◀▶** to select “FM” or “AM”, then press **ENTER**.

FM : When listening to an FM broadcast.

AM : When listening to an AM broadcast.

- 5 Press **TUNE +** or **TUNE -** to select the station you want to hear.

Scanning is performed until it finds an available radio station. When it finds a radio station, it stops the scan automatically and tunes in.









- The modes for receiving FM broadcasts consists of “Auto” mode that automatically searches available broadcast stations and “Manual” mode that lets you tune in using buttons to change the frequency. The default setting is “Auto”. You can also use “Direct Tune” to tune in by entering the frequency directly. In “Auto” mode, you cannot tune in to radio stations if the reception is not good. If this is the case, then use the “Manual” mode or “Direct Tune” to tune in.

Operation buttons	Function
TUNE +, -	Tuning (up/down)
CH/PAGE ▲▼	Preset channel selection
FAVORITE STATION 1 - 3	Call up favorite stations (Press and hold) Add to the favorite stations



■ Adding to the FAVORITE STATION button ([page 94](#))

■ Operations available through the OPTION button

- Tuning in by entering the radio frequency (Direct Tune) ( [page 63](#))
- Changing the tuning mode (Tune Mode) ( [page 64](#))
- Presetting the current broadcast station (Preset Memory) ( [page 65](#))
- Tuning in to radio stations and presetting them automatically (Auto Preset Memory) ( [page 66](#))
- Specify a name for the preset broadcast station (Preset Name) ( [page 66](#))
- Skipping preset broadcast stations (Preset Skip) ( [page 67](#))

Tuning in by entering the radio frequency (Direct Tune)

You can enter the receiving frequency directly to tune in.

- 1 Press OPTION.**
The option menu screen is displayed.
- 2 Use Δ / ∇ to select "Direct Tune", then press ENTER.**
The direct tuner screen is displayed.
- 3 Use Δ / ∇ to select a number and press \triangleright .**
The screen that lets you enter the frequency is displayed.
 - If \triangleleft is pressed, the immediately preceding input is cancelled.
- 4 Repeat step 3 and enter the frequency of the radio station you want to hear.**
- 5 When setting is completed, press ENTER.**
The preset frequency is tuned in.



Changing the tuning mode (Tune Mode)

You can change the mode for tuning into FM broadcasts. If you cannot tune in automatically with "Auto" mode, then change the mode to "Manual" and tune in manually.

- 1 Press OPTION.**
The option menu screen is displayed.
- 2 Use $\Delta \nabla$ to select "Tune Mode", then press ENTER.**
- 3 Use $\triangleleft \triangleright$ to select tuning mode, then press ENTER.**

Auto : Automatically tune to the station.

Manual : Manually tune to the station.

Listening to preset stations

- 1 Use CH/PAGE $\blacktriangle \blacktriangledown$ to select the desired preset channel.**



- You can also select preset broadcast stations by pressing PRESET CH + or PRESET CH - on the main unit.



Presetting the current broadcast station (Preset Memory)

Your favorite broadcast stations can be preset so that you can tune them in easily. Up to 56 stations can be preset.

- 1 Tune in the broadcast station you want to preset** (👉 [page 62](#) “Listening to FM/AM broadcasts”).
- 2 Press OPTION.**
The option menu screen is displayed.
- 3 Use Δ / ∇ to select “Preset Memory”, then press ENTER.**
The list of already preset channels is displayed.
- 4 Use Δ / ∇ to select the channel you want to preset, then press ENTER.**
The current broadcast station that is preset.
 - To preset other stations, repeat steps 1 to 4.

Channel	Default settings
1 – 8	92.10 / 92.30 / 92.50 / 92.70 / 93.10 / 93.50 / 93.70 / 94.10 MHz
9 – 16	94.30 / 94.50 / 94.70 / 94.90 / 95.10 / 95.30 / 95.50 / 95.70 MHz
17 – 24	98.10 / 98.30 / 98.50 / 98.70 / 98.90 / 99.10 / 100.10 / 100.30 MHz
25 – 32	100.50 / 100.70 / 100.90 / 101.10 / 101.30 / 101.50 / 101.70 / 101.90 MHz
33 – 40	103.10 / 103.30 / 103.50 / 103.70 / 103.90 / 104.10 / 104.30 / 104.50 MHz
41 – 48	104.70 / 104.90 / 105.10 / 105.30 / 105.50 / 105.70 / 105.90 / 106.10 MHz
49 – 56	106.30 / 106.50 / 106.70 / 106.90 / 107.10 / 107.30 / 107.50 / 107.90 MHz



Tuning in to radio stations and presetting them automatically (Auto Preset Memory)

Up to 56 stations can be preset.

If "Auto Preset Memory" is performed after performing "Preset Memory", the "Preset Memory" settings will be overwritten.

- 1 Press OPTION.**
The option menu screen is displayed.
- 2 Use $\Delta\nabla$ to select "Auto Preset Memory", then press ENTER.**
- 3 Press ENTER.**
The unit starts to tune in to radio stations automatically and preset them.
 - When presetting is completed, "Completed" is displayed for about 5 seconds and the option menu screen turns off.

Specify a name for the preset broadcast station (Preset Name)

You can set the name to the preset broadcast station or change it. Up to eight characters can be input.

- 1 Press OPTION.**
The option menu screen is displayed.
- 2 Use $\Delta\nabla$ to select "Preset Name", then press ENTER.**
The Preset Name screen is displayed.
- 3 Use $\triangleleft\triangleright$ to select the group of the broadcast station you want to name.**
- 4 Use $\Delta\nabla$ to select the broadcast station you want to name, then press ENTER.**
- 5 Use $\Delta\nabla$ to select a name label, then press ENTER.**
The screen that lets you edit the preset name is displayed.
 - If you select "Set Defaults", then the unit returns to displaying the frequency.
- 6 Enter the characters, then press "OK".**
 - For character input, see [page 138](#).



Skipping preset broadcast stations (Preset Skip)

You can set in advance, the stations you do not want to be displayed when tuning in, by groups or by stations. The preset skip setting is useful when tuning in, because only your favorite stations are displayed.

1 Press **OPTION**.

The option menu screen is displayed.

2 Use $\Delta \nabla$ to select "**Preset Skip**", then press **ENTER**.

The Preset Skip screen is displayed.

3 To set the stations you want to skip by groups

① Use $\triangleleft \triangleright$ to select the group of broadcast stations you want to skip.

② Press \triangle to select "**Set No.* - * to Skip**", then press **ENTER**.

All broadcast stations in the group "*** - ***" you selected are not displayed.

(* are the selected group numbers)

To set the stations you want to skip by stations

① Use $\triangleleft \triangleright$ to select the group of broadcast stations you want to skip.

② Use $\Delta \nabla$ to select the broadcast station you want to skip.

③ Use $\triangleleft \triangleright$ to select "**Skip**".

The station you selected is not displayed.

Cancelling preset skip

1 While the **Preset Skip** screen is displayed, use $\triangleleft \triangleright$ to select a group containing a broadcast station to cancel the skip for.

2 Use $\Delta \nabla$ to select a broadcast station to cancel the skip for.

3 Use $\triangleleft \triangleright$ to select "**On**".

The skip is cancelled.

NOTE

- You cannot cancel the skip for each group.



Listening to Internet Radio

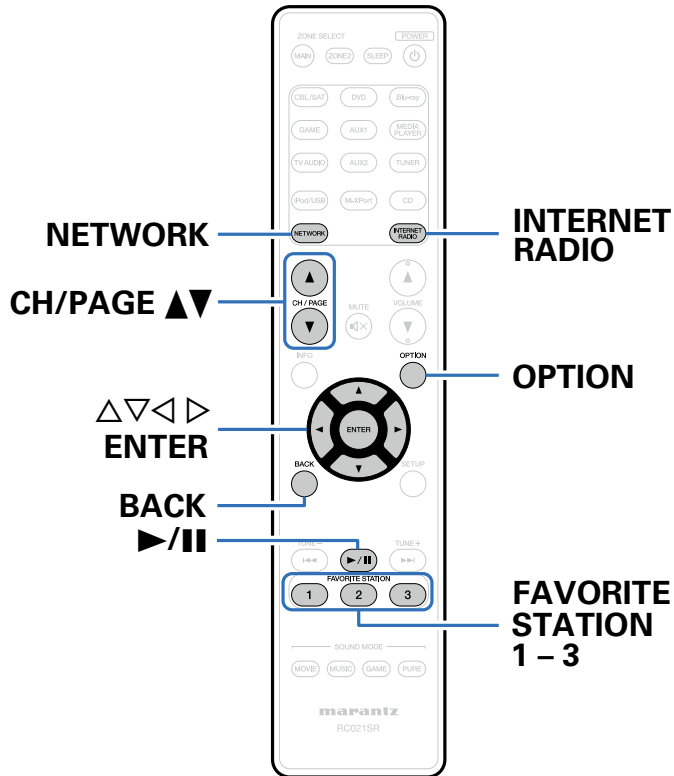

- Internet Radio refers to radio broadcasts distributed over the Internet. Internet Radio stations from around the world can be received.
- The broadcast station types and specifications supported by this unit for playback are as follows.
 - **WMA** (Windows Media Audio)
 - **MP3** (MPEG-1 Audio Layer-3)
 - **MPEG-4 AAC**



Listening to Internet Radio

- 1 Prepare for playback.**
 - Check the network environment, then turn on this unit's power (see page 45 "Connecting to a home network (LAN)").
- 2 Press NETWORK.**
 - You can also press INTERNET RADIO to select the input source "Internet Radio" directly.
- 3 Use $\Delta \nabla \triangleleft \triangleright$ to select "Internet Radio", then press ENTER.**

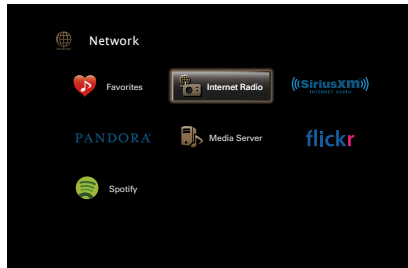

- 4 Use $\Delta \nabla$ to select the item you want to play, then press ENTER.**



***** (Country name) :

- Displays typical Internet Radio stations your country.

Search Stations :

- Displays all Internet Radio stations that this unit can tune in to.

Search Podcasts :

- Displays Internet Radio stations in the podcasts that this unit can tune in to.

Recommended Stations :

- Displays recommended Internet Radio stations.



radiomarantz.com :

- Displays Internet Radio stations added to favorites in vTuner. For instructions on how to add to favorites in vTuner, see "Using vTuner to add Internet Radio stations to favorites" ( page 71).

Recently Played :

- Displays recently played Internet Radio stations. Up to 20 stations can be stored in "Recently Played".

Search by Keyword :

- Displays Internet Radio stations searched by keyword. For character input, see [page 138](#).

5 Use Δ / ∇ to select the station, then press ENTER.

Playback starts once buffering reaches "100%".

Operation buttons	Function
	Playback / Stop
ENTER	(Press and hold) Stop
CH/PAGE Δ / ∇	Page previous / Page next
FAVORITE STATION 1 – 3	Call up favorite stations (Press and hold) Add to the favorite stations
INTERNET RADIO	Last played Internet Radio station



- The display switches between track title and radio station name etc. each time the STATUS button is pressed.
- Any characters that cannot be displayed are replaced with "." (period).

NOTE

- The radio station database service may be suspended or be otherwise unavailable without notice.

Playing the last played Internet Radio station

1 Press INTERNET RADIO.

The source switches to "Internet Radio" and the last played radio station plays.



Using vTuner to add Internet Radio stations to favorites

There are many Internet Radio stations in the world, and this unit can tune into these stations. But finding the radio station you want to hear may be difficult, because there are too many stations. If this is the case, then please use vTuner, an Internet Radio station search website specifically designed for this unit. You can use your PC to search Internet Radio stations and add them as your favorites. This unit can play radio stations added to vTuner.

- 1 Check the MAC address of this unit (☞ page 173 "Information").**
 - The MAC address is necessary when you create an account for vTuner.
- 2 Use your PC to access the vTuner website (<http://www.radiomarantz.com>).**
- 3 Enter the MAC address of this unit, then click "Go".**
- 4 Enter your E-mail address and a password of your choice.**

- 5 Select the search criteria (genre, region, language, etc.) of your choice.**
 - You can also enter a keyword to search for a station you want to hear.
- 6 Select the radio station of your choice from the list, and then click the Add to Favorites icon.**
- 7 Enter the name of the favorite group, then click "Go".**

A new favorite group that includes the selected radio station is created.

 - Internet Radio stations added to favorites in vTuner can be played from "radiomarantz.com" (☞ page 69) with this unit.

■ Operations available through the OPTION button

- Add to favorites from the Option menu (Save to Favorites) (☞ page 101)
- Searching content with keywords (Text Search) (☞ page 102)
- Playing back music and a favorite picture at the same time (Slideshow) (☞ page 103)



Playing back files stored on a PC and NAS

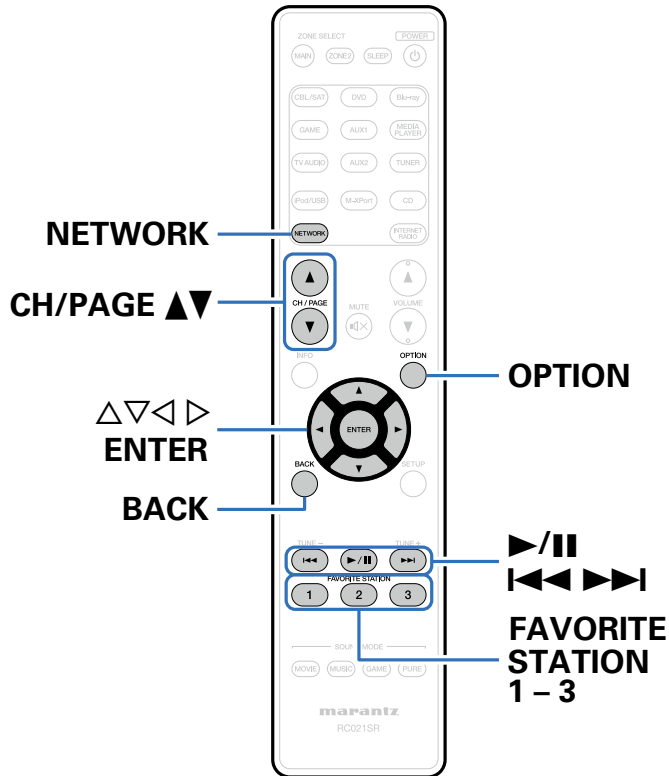

- This unit can play back music files and playlists (m3u, wpl) stored on a PC and on Network Attached Storage (NAS) that supports DLNA.
- The network audio playback function of this unit connects to the server using technologies shown below.
 - Windows Media Player Network Sharing Service
 - Windows Media DRM10
- This unit can play back the following files.
 - **WMA** (Windows Media Audio)
 - **MP3** (MPEG-1 Audio Layer-3)
 - **WAV**
 - **MPEG-4 AAC**
 - **FLAC** (Free Lossless Audio Codec)
 - **JPEG**
 - **ALAC** (Apple Lossless Audio Codec)



Applying media sharing settings

Here, we apply the settings to share music files stored on a PC and NAS on the network. If you are using a Media Server, be sure to apply this setting first.

■ When using Windows Media Player 12 (Windows 7 / Windows 8)

- 1 Start up Windows Media Player 12 on the PC.
- 2 Select "More streaming options..." in the "Stream".
- 3 Select "Allowed" in the drop-down list for "SR5008".
- 4 Select "Allowed" in the drop-down list for "Media programs on this PC and remote connections...".
- 5 Click "OK" to finish.

■ When using Windows Media Player 11

- 1 Start up Windows Media Player 11 on the PC.
- 2 Select "Media Sharing" in the "Library".
- 3 Click the "Share my media" check box, select "SR5008", and then click "Allow".
- 4 As you did in step 3, select the icon of the device (other PCs and mobile devices) you want to use as a media controller, and then click "Allow".
- 5 Click "OK" to finish.

■ Sharing media stored in NAS

Change settings on the NAS to allow this unit and other devices (PCs and mobile devices) used as media controllers to access the NAS. For details, see the owner's manual that came with the NAS.



Playing back files stored on a PC and NAS

Use this procedure to play music files, image files or playlists.

1 Prepare for playback.

- ① Check the network environment, then turn on this unit's power (☞ page 45 "Connecting to a home network (LAN)").
- ② Prepare the computer (☞ Computer's operating instructions).

2 Press NETWORK.

3 Use $\Delta \nabla \triangleleft \triangleright$ to select "Media Server", then press ENTER.

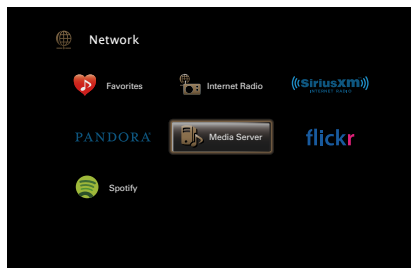

4 Use $\Delta \nabla$ to select the server including the file to be played, then press ENTER.

5 Use $\Delta \nabla$ to select the file, then press ENTER. Playback starts once buffering reaches "100%".

Operation buttons	Function
$\blacktriangleright / \parallel$	Playback / Pause
$\blacktriangleleft \blacktriangleright$	Previous / Next (Press and hold) Fast-reverse / Fast-forward*
ENTER	Playback / Pause (Press and hold) Stop
$\Delta \nabla$	Previous / Next (Press and hold) Fast-reverse / Fast-forward*
CH/PAGE $\blacktriangle \blacktriangledown$	Page previous / Page next
FAVORITE STATION 1 - 3	Call up favorite stations (Press and hold) Add to the favorite stations

* This function is available while an MP3 / WAV / AAC / FLAC file is being played back.





- The display switches between track title, artist name, and album title each time the STATUS button is pressed.
- When a WMA (Windows Media Audio), MP3 or MPEG-4 AAC file includes album art data, the album art can be displayed while the music files are playing.
- If you use Ver.11 or later of Windows Media Player, the album art for WMA files can be displayed.
- WMA Lossless files can be played when using a server supporting transcoding, such as Windows Media Player Ver. 11 or later.

NOTE

- When playing back music files with your PC or NAS connected through wireless LAN, audio may be interrupted depending on your wireless LAN environment. In this case, play back music files with your PC or NAS connected through wired LAN.
- Depending on the size of the still picture (JPEG) file, some time may be required for the file to be displayed.
- The order in which the tracks/files are displayed depends on the server specifications. If the tracks/files are not displayed in alphabetical order due to the server specifications, searching by the first letter may not work properly.

■ Operations available through the OPTION button

- Performing repeat playback (Repeat) (page 100)
- Performing random playback (Random) (page 100)
- Add to favorites from the Option menu (Save to Favorites) (page 101)
- Searching content with keywords (Text Search) (page 102)
- Playing back music and a favorite picture at the same time (Slideshow) (page 103)
- Playing back still pictures in sequential order (Slideshow Interval) (page 104)
- Displaying your desired video during audio playback (Video Select) (page 104)
- Adjusting the picture quality for your viewing environment (Picture Mode) (page 105)
- Playing music in All Zone Stereo (page 106)



Viewing photographs on the Flickr site

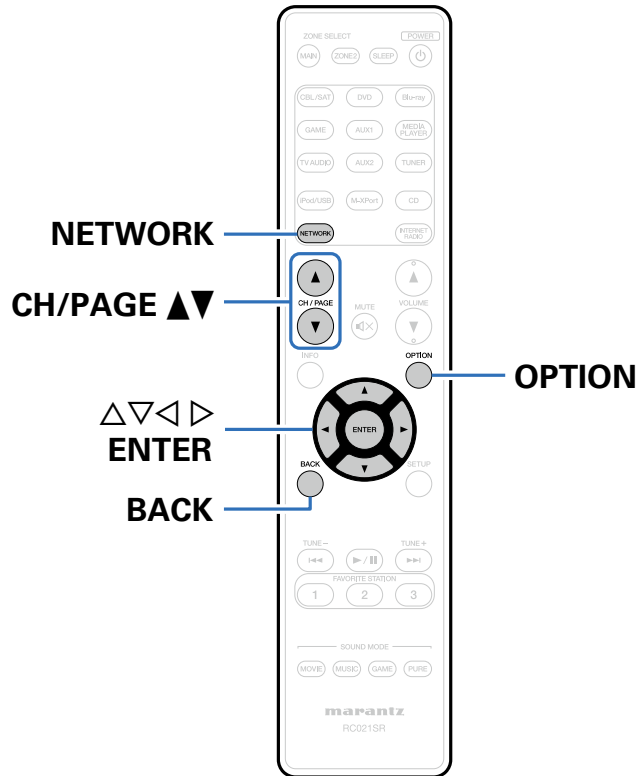

- Flickr is an online photograph sharing service that started in 2004. You can use this unit to view photographs that have been made public by Flickr users. You do not need an account to use Flickr. To view photographs that you recorded yourself, you need an account in order to upload these photographs to the Flickr server. For details, see the Flickr homepage.
<http://www.flickr.com/>
- You can view photographs shared by particular users, or all of the photographs shared on Flickr.



Viewing photographs shared by particular users

- 1 Prepare for playback.**
 - Check the network environment, then turn on this unit's power (☞ [page 45](#) "Connecting to a home network (LAN)").
- 2 Press NETWORK.**
- 3 Use $\Delta \nabla \triangleleft \triangleright$ to select "Flickr", then press ENTER.**

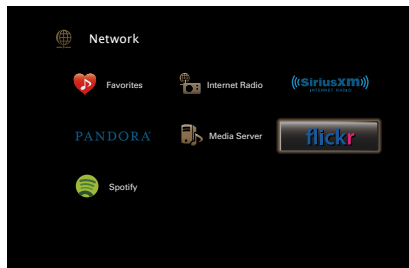

- 4 Use $\Delta \nabla$ to select "Add Flickr Contact", then press ENTER.**

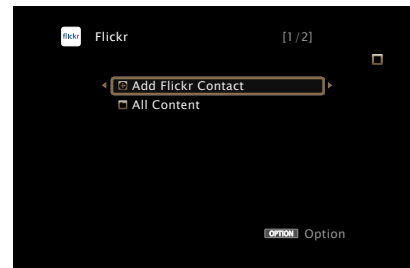

- 5 In "Contact", add the screen name (user name you want to view) you want to add.**
 - For character input, see [page 138](#).
- 6 After inputting the "Contact", press "OK".**

The screen name is added to "Contact", and the screen name you entered in Step 5 is displayed on the top screen of Flickr.

 - If you enter a screen name that does not exist, "The Flickr Contact you entered could not be found" is displayed. Check and enter the correct screen name.



7 Use $\Delta\nabla$ to select the folder, and then press ENTER.

Favorites :

- Displays the favorite photographs of the specified user.

Photostream :

- Displays a list of shared photographs.

PhotoSets :

- Displays the folder (photograph album) list.

Contacts :

- Displays the screen name used by the specified user in Contacts.

Remove this Contact :

- Deletes a user from Flickr Contact.

Add this Contact :

- Adds a user from Flickr Contact.

8 Use $\Delta\nabla$ to select the file, and then press ENTER.

The selected file is displayed.

Operation buttons	Function
	Playback
ENTER	(Press and hold) Stop
$\Delta\nabla$	Previous / Next
CH/PAGE $\blacktriangle\blacktriangledown$	Page previous / Page next

Viewing all photographs on Flickr

1 Use $\Delta\nabla$ to select "All Content", then press ENTER.

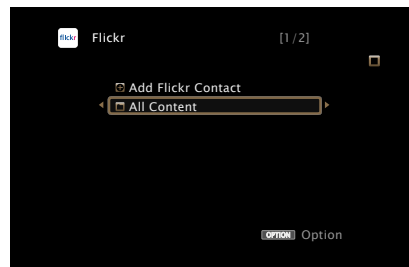

2 Use $\Delta\nabla$ to select the folder, and then press ENTER.

Interestingness :

- Displays photographs that are popular from the number of user comments or number of times they are added as favorites.

Recent :

- Displays the most recently added photographs.

Search by text :

- Search for photographs by keyword.

3 Use $\Delta\nabla$ to select the file, and then press ENTER.





The selected file is displayed.



NOTE

- Depending on the file format, some photographs may not be viewable.

■ Operations available through the OPTION button

- Playing back still pictures in sequential order (Slideshow Interval) ( page 104)
- Displaying your desired video during audio playback (Video Select) ( page 104)
- Adjusting the picture quality for your viewing environment (Picture Mode) ( page 105)
- Playing music in All Zone Stereo ( page 106)



Listening to Pandora®

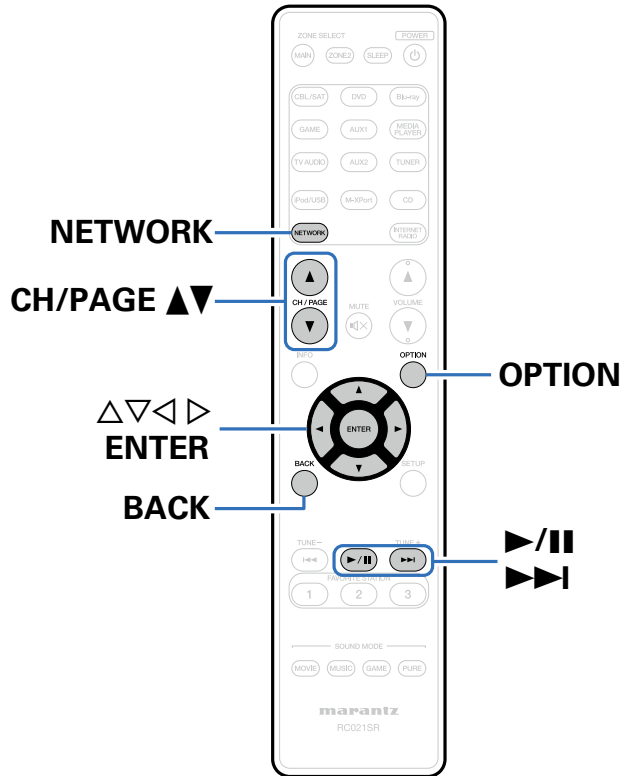

Pandora is an automated music recommendation and Internet Radio service created by the Music Genome Project.

To listen to Pandora you will need a free Pandora account. If you do not have a Pandora account, you can create one at www.pandora.com or from the Pandora smartphone application.

It is necessary to associate this machine with a Pandora account by visiting <http://www.pandora.com/marantz> from your PC.



Listening to Pandora®

1 Prepare for playback.

- ① Check the network environment, then turn on this unit's power (☞ page 45 "Connecting to a home network (LAN)").
- ② Complete step 4 and obtain a Pandora account.
 - If you already have a Pandora account, you do not need to obtain a new account. Use your existing Pandora account.

2 Press NETWORK.

3 Use $\Delta \nabla \triangleleft \triangleright$ to select "Pandora", then press ENTER.

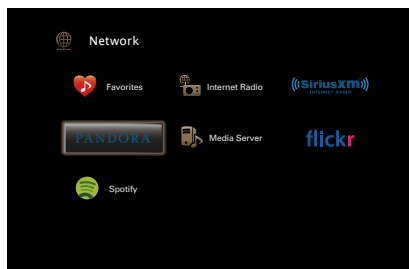

4 If you have a Pandora account, use $\Delta \nabla$ to select "I have a Pandora account", then press ENTER.

- If you do not have a Pandora account, press ∇ to select "I am new to Pandora". The URL of Pandora and activation code are displayed. Access the Pandora web page from your PC and register the displayed activation code and account information. Then press ENTER.

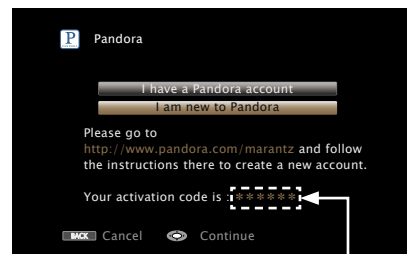

This is an identification code required to register your purchased product to the Pandora service. This code is used to obtain your account.



5 Input "Email address" and "Password".

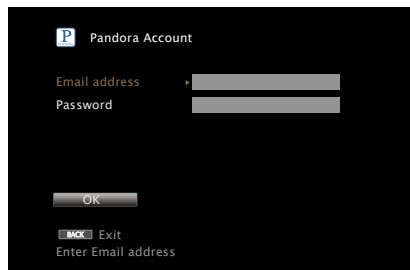

- For character input, see [page 138](#).
- Press BACK to cancel the input. When "Cancel Input?" is displayed, select "Yes", then press ENTER.

6 After inputting the "Email address" and "Password", select "OK", then press ENTER.

If the "Email address" and "Password" match, the top menu for Pandora is displayed.

Creating a new station

You can create up to 100 radio stations.

1 Use Δ / ∇ to select "New Station", then press ENTER.



2 Input a track or artist name, then press "OK".



- For character input, see [page 138](#).



3 Use Δ / ∇ to select “Search by Artist” or “Search by Track”, then press ENTER.

You can search and display a list by track or artist.

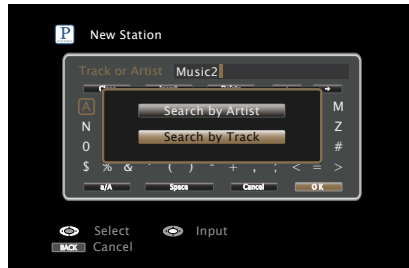

4 Press Δ / ∇ , select a file (e.g. Music 2) from the list, and press ENTER.

“Radio” is added to the end of a filename, and your new station is created (e.g. Music 2 Radio).



Operation buttons	Function
\blacktriangleright / \parallel	Playback / Pause
$\blacktriangleright\blacktriangleright$	Skips the current track
ENTER	Playback / Pause (Press and hold) Stop
∇	Skips the current track
CH/PAGE \blacktriangle / \blacktriangledown	Page previous / Page next



- You can create up to 100 Stations (radio stations).
- Your new station will play music with similar qualities to the artist or track you entered.



Listening to an existing station

- 1 Use Δ / ∇ and select the radio station ("Music 2 Radio") that you want to listen to, and press ENTER.

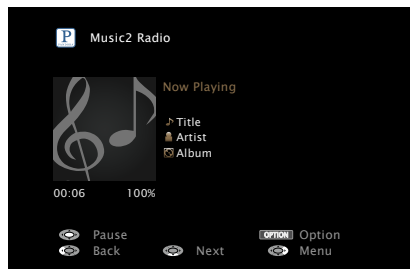

- You can Skip up to 6 Tracks that are being played back within 1 hour.

Listening to created radio stations at random

- 1 Use Δ / ∇ to select "Quick Mix", then press ENTER. Created radio stations are selected at random, and tracks are streamed.



Giving Feedback and Managing Stations

You can personalize your stations by providing feedback.

- 1 **Press  while a track is playing.**
The Pandora menu screen is displayed.

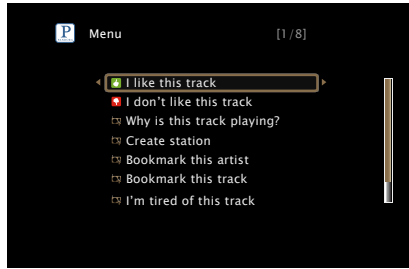

I like this track :

- Press when you like the track that is being played.
- It will return to the Play Screen. And  (Thumbs up) icon is displayed. (The icon is not displayed on the next track.)

I don't like this track :

- Press when you don't like the track that is being played.
- It will return to the Play Screen. And  (Thumbs down) icon is displayed. (The icon is not displayed on the next track.)

Why is this track playing? :

- Displays the reason why Pandora selected this track.

Create station :

- Creates a Station for the Track or Artist being played.

Bookmark this artist :

- Bookmarks the artist currently being played.
- You can check on a computer or iPhone etc.
- For details, see the Pandora web page.

Bookmark this track :

- Bookmarks the track currently being played.
- You can check on a computer or iPhone etc.
- For details, see the Pandora web page.

I'm tired of this track :

- Press when you don't like the track that is being played.
- The track will not be played for 1 month.

Delete this station :

- Press when you want to delete the station that is being played.



- You can create up to 100 Stations (radio stations).



Sign Out

Disassociate this unit from your Pandora account.

- 1 Use Δ / ∇ to select “Sign Out”, then press ENTER.

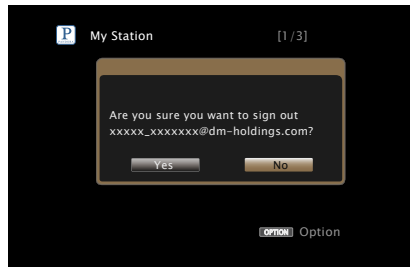

- 2 When the popup menu appears, use \triangleleft / \triangleright to select “Yes”, then press ENTER.

■ Operations available through the OPTION button

- Displaying your desired video during audio playback (Video Select) (🔗 page 104)
- Adjusting the picture quality for your viewing environment (Picture Mode) (🔗 page 105)
- Playing music in All Zone Stereo (🔗 page 106)



Listening to SiriusXM Internet Radio

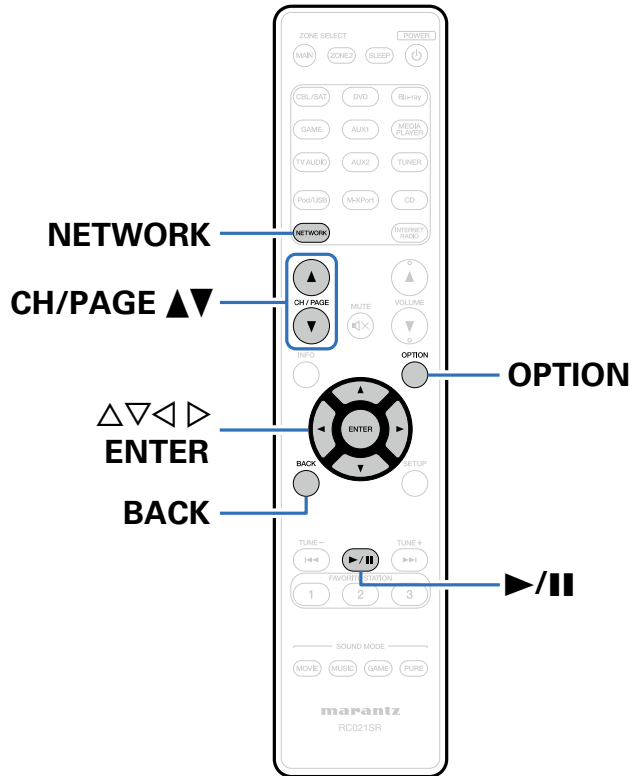

Enjoy anywhere access to the unparalleled content of SiriusXM. Whether on your computer, smartphone, tablet, Lynx Portable Enjoy anywhere access to the unparalleled content of SiriusXM.

Whether on your computer, smartphone, tablet, Lynx Portable Radio, or compatible Internet-connected device, you don't need to be in your vehicle to enjoy SiriusXM.

For details, see the SiriusXM homepage.

<http://www.siriusxm.com>

Listening to SiriusXM Internet Radio

Over 120-channels of the SiriusXM programming you love, including commercial-free music plus sports, talk, news and entertainment. Listen anywhere on your computer or smartphone.

1 Prepare for playback.

- ① Check the network environment, then turn on this unit's power (see [page 45](#) "Connecting to a home network (LAN)").
- ② Access the following website from your PC and obtain a SiriusXM account.
<http://www.siriusxm.com>
 - If you already have a SiriusXM account, you do not need to obtain a new account. Select "Sign in" in step 4, and enter your existing SiriusXM account.

2 Press NETWORK.



3 Use $\Delta \nabla \triangleleft \triangleright$ to select "SiriusXM", then press ENTER.

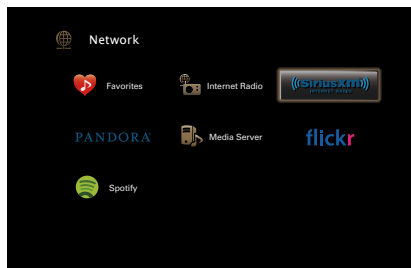

4 Select "Sign in", then press ENTER.

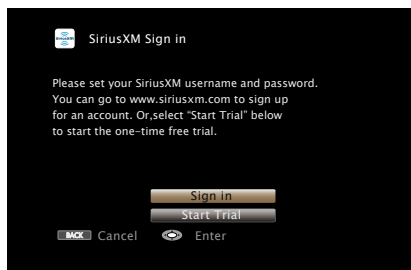

5 Input the "Username" and "Password".

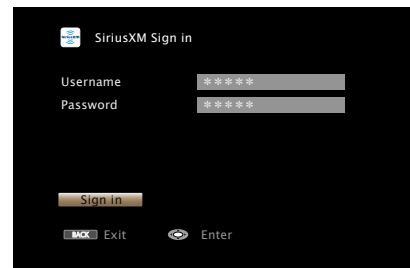

• For character input, see [page 138](#).

6 Select the "Sign in", and then press ENTER.
The top menu of SiriusXM is displayed.

7 Use $\Delta \nabla$ to select the genre, then press ENTER.

8 Use $\Delta \nabla$ to select the file, and then press ENTER.
The selected file is displayed.

Operation buttons	Function
$\blacktriangleright / \parallel$	Playback / Stop
ENTER	Playback (Press and hold) Stop
CH/PAGE $\blacktriangle \blacktriangledown$	Page previous / Page next



Sign Out

Disassociate this unit from your SiriusXM account.

- 1 Use Δ / ∇ to select "Sign Out", then press ENTER.
- 2 When the popup menu appears, use \triangleleft / \triangleright to select "Yes", then press ENTER.

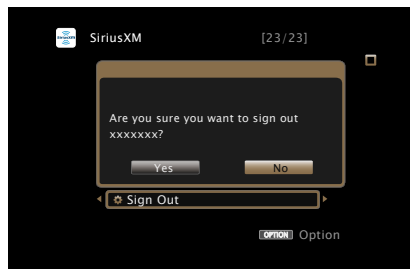

Operations available through the OPTION button

- Displaying your desired video during audio playback (Video Select) (🔍 page 104)
- Adjusting the picture quality for your viewing environment (Picture Mode) (🔍 page 105)
- Playing music in All Zone Stereo (🔍 page 106)



Listening to Spotify

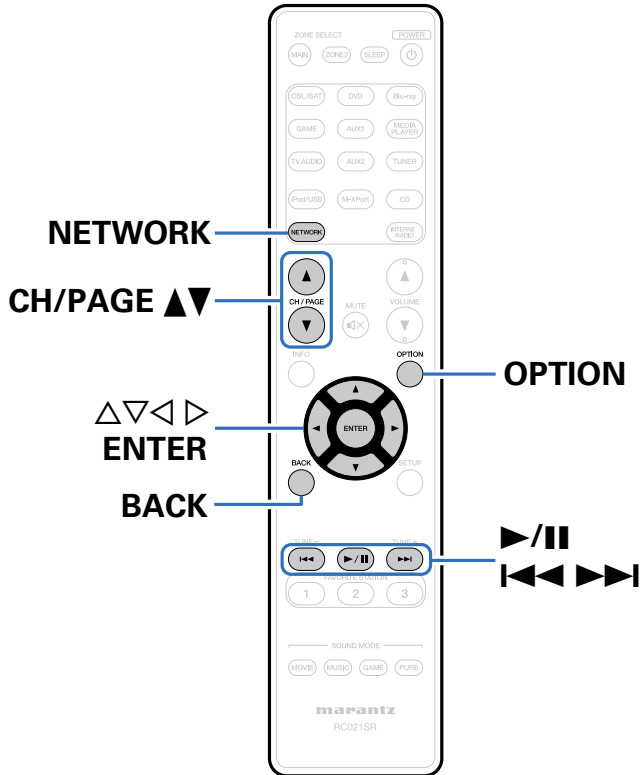

Introduce your Marantz to a whole new world of music. With Spotify, you can enjoy instant access to millions of songs. A Spotify Premium subscription is required. For details, see the Spotify homepage. <http://www.spotify.com>

Listening to Spotify

1 Prepare for playback.

- ① Check the network environment, then turn on this unit's power (see page 45 "Connecting to a home network (LAN)").
- ② Complete step 5 and obtain a Spotify account.
 - If you already have a Spotify account, you do not need to obtain a new account. Use your existing Spotify account.

2 Press NETWORK.

3 Use ▲▼◀▶ to select "Spotify", then press ENTER.



4 If you have a Spotify account, then press ENTER.

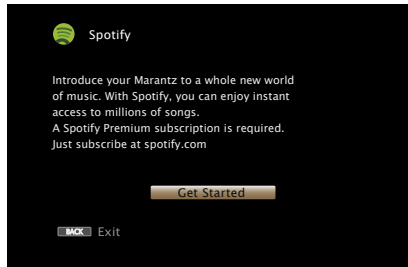

5 Use Δ ∇ \triangleright to enter your username and password.

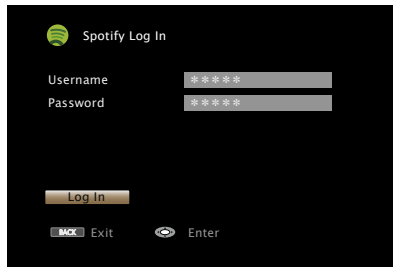

- For character input, see [page 138](#).
The types of characters that can be input are as shown below.

[Upper case characters/Numbers/Symbols]
 ABCDEFGHIJKLMNOPQRSTUVWXYZ
 ÄÅÁÂÃÄÅÆÇÐÈÉÊËÌÍÎÏÑÒÓÔÕÖØÙÚÛÜÝÞ
 0123456789
 ! " # \$ % & ' () * + , ; < = >

[Lower case characters/Numbers/Symbols]
 abcdefghijklmnopqrstuvwxyz
 äåáâãäåæçðèéêëìíîïñòóôõöøùúûüýþß
 0123456789
 . @ - _ / : ; ' ? [\] ^ ' { | }

- The password should be no longer than 99 characters.
- Press BACK to cancel the input. When “Cancel Input?” is displayed, select “Yes”, then press ENTER.



6 After inputting the username and password, select “Log In”, then press ENTER.

If the username and password match, the top menu for Spotify is displayed.

7 Use $\Delta\nabla$ to select menu and then press ENTER.

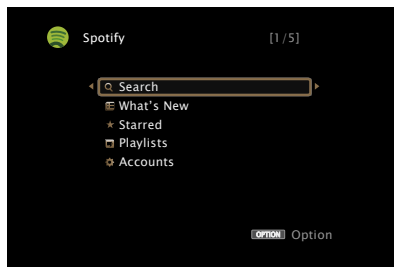

Search :

- Searches for tracks, artists and albums by entering keywords.

What's New :

- Displays the list of the latest albums.

Starred :

- Displays the list of the starred tracks.

Playlists :

- Displays the playlists for Spotify.

Accounts :

- Manages accounts (Log out, Add new user, Switch to user).

8 Use $\Delta\nabla$ to select a station, and press ENTER to start playback.

Playback starts and the following screen appears.

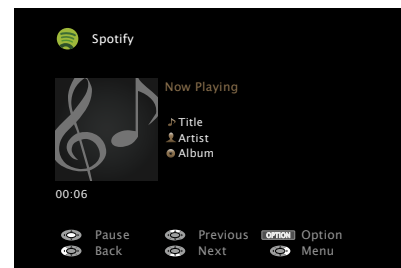

Operation buttons	Function
$\blacktriangleright/\parallel$	Playback / Pause
$\blacktriangleleft\blacktriangleright$	Previous / Next
$\blacktriangleleft\blacktriangleleft\blacktriangleright\blacktriangleright$	(Press and hold) Fast-reverse / Fast-forward
ENTER	Playback / Pause (Press and hold) Stop
$\Delta\nabla$	Previous / Next (Press and hold) Fast-reverse / Fast-forward
CH/PAGE $\blacktriangle\blacktriangledown$	Page previous / Page next



- 9 Press ▷ while a track is playing.**
The Spotify menu screen is displayed.

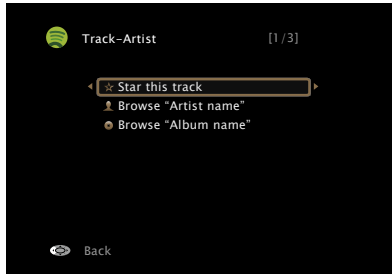

Star this track :

- Adds a star to the selected track.

Browse “Artist name” :

- Displays the list of albums by the artist of the track that is being played back.

Browse “Album name” :

- Displays the list of tracks on the album that is being played back.
-



- The display switches between track title, artist name, and album title each time the STATUS button is pressed.

■ Operations available through the OPTION button

- Performing repeat playback (Repeat) (🔗 [page 100](#))
- Performing random playback (Random) (🔗 [page 100](#))
- Displaying your desired video during audio playback (Video Select) (🔗 [page 104](#))
- Adjusting the picture quality for your viewing environment (Picture Mode) (🔗 [page 105](#))
- Playing music in All Zone Stereo (🔗 [page 106](#))



Adding to the FAVORITE STATION button



FAVORITE STATION 1 – 3

With a single press of these, you can call up registered radio stations and contents

You can add up to three types of content.

1 Press and hold one of the FAVORITE STATION 1 – 3 buttons for 3 seconds or longer while playing back a content or listening to a radio station.

The content you are playing back or the radio station you are listening to is registered to the pressed button.

- Contents that can be added to the FAVORITE STATION button differ depending on the input source.

Input source	Contents that can be added
TUNER	Radio station
Internet Radio	Top list of content / Internet Radio station
Media Server	Top list of content / Track of Media Server
Flickr	Top list of content
Pandora	Top list of content
SiriusXM	Top list of content
Spotify	Top list of content
Favorites	Top list of content / Internet Radio station / Track of Media Server



Playing back content added to the FAVORITE STATION button

You can easily call up content by pressing the FAVORITE STATION button.

1 Press one of the FAVORITE STATION 1 – 3 buttons that you added content to.

Playback starts.



- Internet Radio stations are already registered to the FAVORITE STATION 1 – 3 buttons. However, you may not be able to play the stations due to restrictions imposed by the radio stations.

NOTE

- The following operations update the database on the Media Server, which may make the added music files unplayable.
 - When you quit the Media Server and then restart it.
 - When music files are deleted or added on the Media Server.



AirPlay function

Enjoy music from your iTunes library with high quality sound anywhere in your home.

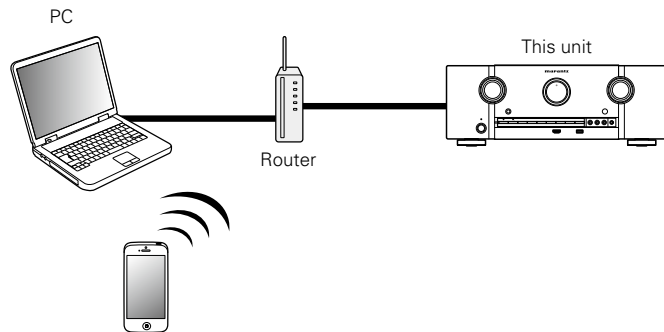

Streaming music stored in iPhone, iPod touch, or iPad directly to the unit

If you update your "iPhone/iPod touch/iPad" to iOS 4.2.1 or later, you can stream music stored in your "iPhone/iPod touch/iPad" directly to this unit.

- 1 Make the Wi-Fi settings for iPhone, iPod touch, or iPad.**
 - For details, see your device's manual.
- 2 Startup iPhone, iPod touch, or iPad music.**
 - ▣ is displayed on the iPhone, iPod touch or iPad screen.
- 3 Tap the AirPlay icon ▣.**
- 4 Select the speaker you want to use.**

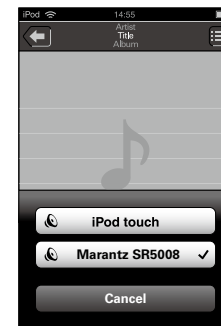
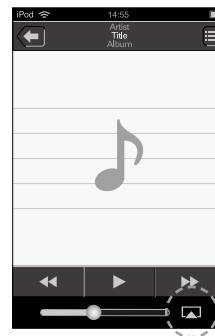

Playing iTunes music with this unit

- 1 Install iTunes 10, or later, on a Mac or Windows PC that is connected to the same network as this unit.**
- 2 Turn this unit ON.**
Set "IP Control" (🔌 page 173) to "Always On" for this unit.
- 3 Launch iTunes and click the AirPlay icon  displayed the window and select this unit from the list.**

NOTE

- When "IP Control" is set to "Always On", the unit consumes more standby power.



- 4 Choose a song and click play in iTunes.**
The music will stream to this unit.

Selecting multiple speakers (devices)

It is possible to play iTunes songs on your home's AirPlay compatible speakers (devices) other than those of this unit.

- 1 Click the AirPlay icon  and select "Multiple".**
- 2 Check the speakers you want to use.**

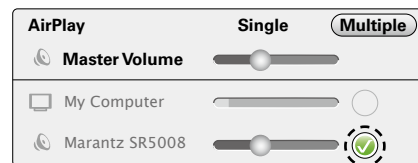

NOTE

- In playback using the AirPlay function, the sound is output at the iPhone, iPod touch, iPad or iTunes volume setting level. You should turn down the iPhone, iPod touch, iPad or iTunes volume prior to playback and then adjust it to a suitable level.



Perform iTunes playback operations with the remote control unit of this unit

With this unit's remote control unit, you can perform iTunes song play, pause, and auto search (cue) operations.

- 1 Select "Edit" – "Preferences..." on the menu.
- 2 Select "Devices" in the iTunes setting window.
- 3 Check "Allow iTunes audio control from remote speakers", and then click "OK".



-  is displayed on the menu screen while AirPlay is being operated.
- Source input will be switched to "NETWORK" when AirPlay playback is started.
- You can stop AirPlay playback by pressing the ◀ or choosing other input source.
- To see song and artist names together, press STATUS on the main unit.
- For information about how to use iTunes, also see the Help for iTunes.
- The screen may differ depending on the OS and software versions.

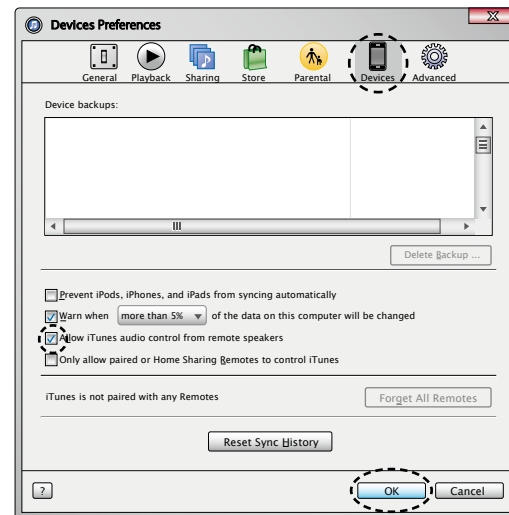

Convenience functions

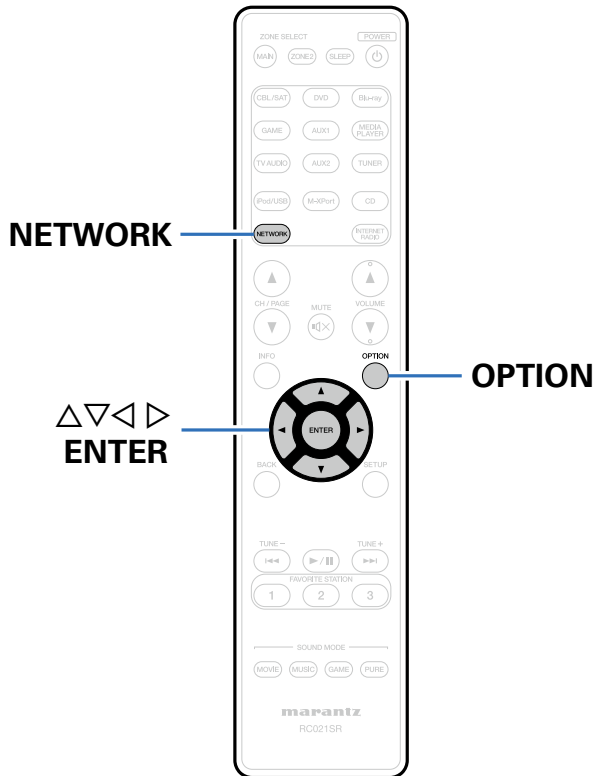

Here, we explain how to use the convenience functions. The source names under the titles of each function's description are sources that allow use of these functions.



Performing repeat playback (Repeat)

❑ **Supported input sources : USB / Media Server / Spotify**

1 While content is playing, press OPTION.

The option menu screen is displayed.

2 Use $\Delta \nabla$ to select "Repeat", then press ENTER.

3 Use $\triangleleft \triangleright$ to select repeat playback mode.

Off (Default) : Repeat playback mode is canceled.

One : A file being played is played repeatedly.

All : All files in the folder currently being played are played repeatedly.

4 Press ENTER.

The display returns to the playback screen.

Performing random playback (Random)

❑ **Supported input sources : USB / Media Server / Spotify**

1 While content is playing, press OPTION.

The option menu screen is displayed.

2 Use $\Delta \nabla$ to select "Random", then press ENTER.

3 Use $\triangleleft \triangleright$ to select random playback mode.

Off (Default) : Disable random playback.

On : Randomly play back all tracks in the current playback folder.

4 Press ENTER.

The display returns to the playback screen.



- During random playback, each time playback of a track is completed, another track is randomly selected for playback from tracks in the folder. Therefore, it's possible that you may hear a track played back more than once during random playback.



Add to favorites from the Option menu (Save to Favorites)

You can add up to 100 items as favorites for Internet Radio and Media Server.

❑ **Supported input sources : Internet Radio / Media Server**

1 While content is playing, press OPTION.

The option menu screen is displayed.

2 Use $\Delta \nabla$ to select "Save to Favorites", then press ENTER.

"Favorite added" is displayed, and the current content is added to favorites.

- The display returns to the playback screen when the procedure is completed.

Playing back content added in "Save to Favorites"

1 Press NETWORK.

2 Use $\Delta \nabla \triangleleft \triangleright$ to select "Favorites", then press ENTER.

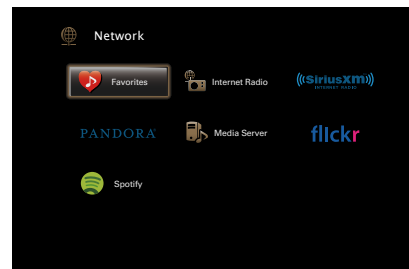

3 Use $\Delta \nabla$ to select the content you want to play, and then press ENTER.

Playback starts.



Deleting content added to favorites (Remove from Favorites)

- 1** Press **NETWORK**.
- 2** Use $\Delta \nabla \triangleleft \triangleright$ to select **"Favorites"**, then press **ENTER**.
- 3** Use $\Delta \nabla$ to select the content you want to delete from favorites, then press **OPTION**.
The option menu screen is displayed.
- 4** Use $\Delta \nabla$ to select **"Remove from Favorites"**, then press **ENTER**.
"Favorite removed" is displayed, and the selected content is deleted from favorites.
 - The display returns to the original screen when the procedure is completed.

Searching content with keywords (Text Search)

- Supported input sources : USB / Internet Radio / Media Server

- 1** While content is playing, press **OPTION**.
The option menu screen is displayed.
- 2** Use $\Delta \nabla$ to select **"Text Search"**, then press **ENTER**.
The keyboard input screen is displayed.
- 3** Enter the first character of the Internet Radio station or file you want to search for, and then press **"OK"**.
 - For character input, see [page 138](#).
- 4** Use $\Delta \nabla$ to select the content you want to play, and then press **ENTER**.
Playback starts.



- "Text Search" searches for Internet Radio stations or files that start with the entered first character from the displayed list.

NOTE

- "Text Search" may not work for some lists.



Playing back music and a favorite picture at the same time (Slideshow)

❑ Supported input sources : USB

1 Play back a still picture.

- Playing back still pictures stored on USB memory devices ( page 59).

2 Play back a music file (page 59).

3 Press OPTION.



The option menu screen is displayed.

4 Use Δ / ∇ to select "Slideshow", then press ENTER.

The option menu disappears, and the picture you were viewing is shown on the screen.

❑ Supported input sources : Internet Radio / Media Server

1 Play back a still picture.

- Playing back still pictures stored on Media Server ( page 72).
- Playing back still pictures stored on Flickr ( page 76).

2 Play back a music file of Media Server or Internet Radio station (page 69, 74).

3 Press OPTION.

The option menu screen is displayed.

4 Use Δ / ∇ to select "Slideshow", then press ENTER.

The option menu disappears, and the picture you were viewing is shown on the screen.



Playing back still pictures in sequential order (Slideshow Interval)

You can play back still picture (JPEG) files stored on a USB memory device or Media Server and pictures on Flickr website as a slide show. The display time can also be set.

❑ **Supported input sources : USB / Media Server / Flickr**

1 While the list is displayed, press **OPTION**.

The option menu screen is displayed.

2 Use $\Delta \nabla$ to select "Slideshow Interval", then press **ENTER**.

3 Use $\triangleleft \triangleright$ to set the display time.

Off : The slide show is not played back.

5s (Default) – 60s : Set the time for displaying a single picture when playing back images in the slide show.

4 Press **ENTER**.

The slide show is displayed on the screen.



- This unit plays back picture (JPEG) files in the order in which they are stored in the folder.

Displaying your desired video during audio playback (Video Select)

This unit can display video from a different source on TV during audio playback.

You can set this for each input source.

❑ **Supported input sources : iPod/USB / CD* / TUNER / NETWORK / M-XPort**

* Available when none of HDMI, component video or video connector is assigned.

1 Press **OPTION** during audio playback.

The option menu screen is displayed.

2 Use $\Delta \nabla$ to select "Video Select", then press **ENTER**.

3 Use $\triangleleft \triangleright$ to select the Video Select mode.

Off (Default) : Disable Video Select mode.

On : Enable Video Select mode.

4 If you selected "On" in step 3, press ∇ and select "Source".

5 Press $\triangleleft \triangleright$ to select the input source for video you want to play back, and press **ENTER**.



Adjusting the picture quality for your viewing environment (Picture Mode)

- ❑ **Supported input sources : CBL/SAT / DVD / Blu-ray / GAME/ AUX1 / AUX2 / MEDIA PLAYER / iPod/USB / NETWORK / CD* / TV AUDIO***

* You can set the picture mode when an HDMI, component video or video connector is assigned.

- 1 While content is playing, press OPTION.**
The option menu screen is displayed.
- 2 Use Δ / ∇ to select "Picture Mode", then press ENTER.**

- 3 Use \triangleleft / \triangleright to select picture mode.**

Off : No picture quality adjustment is done with this unit.

Standard : The standard mode suited for most living room viewing environments.

Movie : A mode suited for watching movies in a dark room such as a theater room.

Vivid : A mode that makes graphic images for games, etc. brighter and more vivid.

Streaming : A mode suited for low bit rate video sources.

Custom : Adjusts the picture quality manually.

- 4 Press ENTER.**
The display returns to the playback screen.



Playing music in All Zone Stereo

You can play back music in another room (ZONE2) simultaneously that is played back in MAIN ZONE.

It is useful when you want to enjoy the same music at the same time in multiple rooms during home party or when you want to play back the same BGM in the entire house.

The All Zone Stereo function can be set for any source.



- Before setting this function, you need to turn on the another room (ZONE2) for which you want to use the All Zone Stereo function.

- 1 Press MAIN to switch the zone mode.**
MAIN lights.
- 2 Press OPTION.**
The option menu screen is displayed.
- 3 Use $\Delta \nabla$ to select "All Zone Stereo", then press ENTER.**
- 4 Use $\triangleleft \triangleright$ to select "On", then press ENTER.**
The input source for the multi-zones (ZONE2) is switched to the same as the one for MAIN ZONE, and playback in the All Zone Stereo mode starts.

■ Stopping the All Zone Stereo function

- 1 During playback in All Zone Stereo, press OPTION.**
The option menu screen is displayed.
- 2 Use $\Delta \nabla$ to select "All Zone Stereo", then press ENTER.**
- 3 Use $\triangleleft \triangleright$ to select "Off", then press ENTER.**



- The All Zone Stereo function is also stopped when you:
 - Turn MAIN ZONE off.
 - Change the input source for MAIN ZONE.
 - Change the sound mode.
- When "HDMI Audio Out" ([page 149](#)) is set to "TV", the All Zone Stereo function is not available.
- When "Input Mode" ([page 157](#)) is set to other than "7.1CH IN", the All Zone Stereo function is available.



Selecting a sound mode

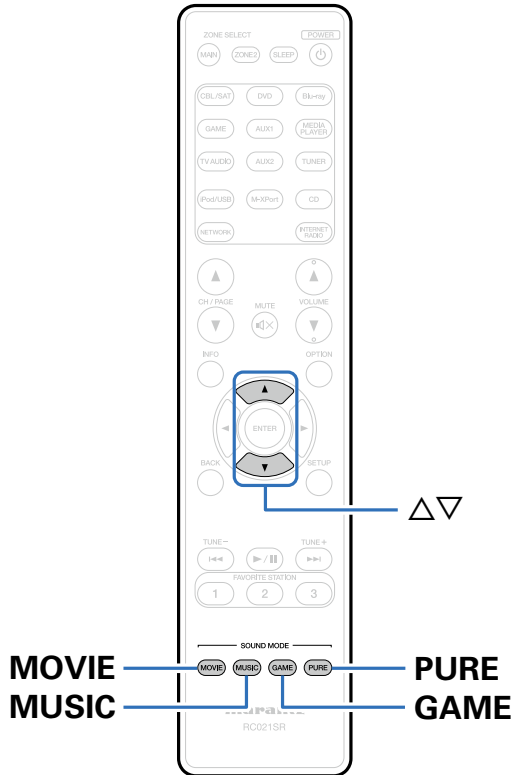

This unit allows you to enjoy various kinds of surround and stereo playback modes.

Multi-channel audio formats are provided on popular movie and music disc formats such as Blu-ray and DVD, as well as being supported by digital broadcasting, and even by streaming movies and music from internet-based subscription services.

This unit supports playback of almost all of these multi-channel audio formats. It also supports surround playback of audio formats other than multi-channel audio such as 2-channel stereo audio.



- For audio formats recorded on a disc, see the disc jacket or label.



Selecting a sound mode

1 Press MOVIE, MUSIC or GAME to select a sound mode.

MOVIE : Switches to the sound mode suitable for enjoying movies and TV programs.

MUSIC : Switches to the sound mode suitable for enjoying music.

GAME : Switches to the sound mode suitable for enjoying games.



- The MOVIE, MUSIC, or GAME button memorizes the last sound mode selected for its button. Pressing MOVIE, MUSIC, or GAME recalls the same sound mode as the one selected at the previous playback.
- If the content played back does not support the previously selected sound mode, the most appropriate sound mode for the content is automatically selected.

■ Switching the sound mode

- Press and hold MOVIE, MUSIC or GAME displays a list of the sound modes that can be selected. Each time you press MOVIE, MUSIC or GAME, the sound mode changes.
- While the list is displayed, you can also use Δ / ∇ to select a sound mode.
- Try out various surround playback modes and enjoy surround playback in your favorite mode.

[Example] When MOVIE is pressed and held

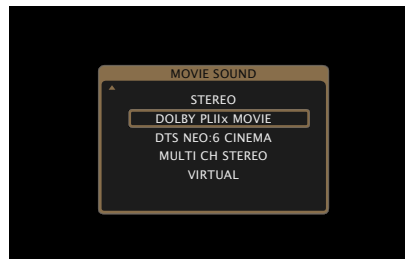

- You can also press SOUND MODE on the main unit to switch the sound mode.



Direct playback

Sound recorded in source is played as is.

- 1 **Press PURE to select “DIRECT”.**
Direct playback begins.







- This can also be set by pressing PURE DIRECT on the main unit.

Pure Direct playback

This mode is for playback with higher sound quality than in “DIRECT” mode, by turning off the front panel display panel, which can eliminate faint low level noise from creeping into sensitive analog circuitry.

- 1 **Press PURE to select “PURE DIRECT”.**
The display goes dark, and Pure Direct playback begins.
The PURE DIRECT indicator lights.



- In DIRECT and PURE DIRECT sound modes, the following items cannot be adjusted.
 - Tone ( page 143)
 - M-DAX ( page 143)
 - MultEQ® XT ( page 145)
 - Dynamic EQ ( page 145)
 - Dynamic Volume ( page 146)
- This can also be set by pressing PURE DIRECT on the main unit.

NOTE

- Video signals are only output when HDMI signals are played in the PURE DIRECT mode.
- When the PURE DIRECT mode has been selected, the display turns off after about 5 seconds.



Auto surround playback

This mode detects the type of input digital signal, and automatically selects the corresponding mode for playback.

- 1 Press PURE to select "AUTO".**
Auto surround playback begins.



- This can also be set by pressing PURE DIRECT on the main unit.



■ Description of sound mode types

Dolby sound mode

Sound mode type	Description
DOLBY PLIIx*1	This mode can be selected when the Dolby Pro Logic IIx decoder is used to play back 2-channel sources in 6.1/7.1-channel surround sound including the surround back channel(s). By adding the surround back channel(s), a more enveloping surround environment is produced, compared to Dolby Pro Logic II. There are three playback modes: "Movie" mode that is optimized for movie playback, "Music" mode that is optimized for music playback, and "Game" mode that is optimized for game play.
DOLBY PLII	This mode can be selected when the Dolby Pro Logic II decoder is used to play back 2-channel sources in 5.1-channel surround sound with an enveloping surround sound experience.
DOLBY PLIIz*2	This mode can be selected when the Dolby Pro Logic IIz decoder is used to play back 2-channel sources in 7.1-channel surround sound with added front height channels. By adding front height channels, the front soundstage becomes dramatically taller, simulating the effect of listening in a large movie theater or concert hall.
DOLBY DIGITAL	This mode can be selected when playing sources recorded with Dolby Digital.
DOLBY DIGITAL EX*1	Using the Dolby Digital EX decoder, this mode plays Dolby Digital sources in 6.1/7.1-channel surround sound with added surround back channel(s). By adding surround back speaker(s), sounds can be heard coming at you from behind and not just from the sides.
DOLBY TrueHD	This mode can be selected when playing sources recorded in Dolby TrueHD.
DOLBY DIGITAL Plus	This mode can be selected when playing sources recorded with Dolby Digital Plus.

*1 This can be selected when "Speaker Config." – "Surr. Back" ( [page 169](#)) is not set to "None".

*2 This can be selected when "Speaker Config." – "Front Height" ( [page 169](#)) is not set to "None".



DTS sound mode

Sound mode type	Description
DTS NEO:6	This mode can be selected when a DTS NEO:6 decoder is used to play back 2-channel source in 6.1/7.1-channel surround sound including the surround back channel. There is a "Cinema" mode optimized for movie playback, and a "Music" mode optimized for music playback.
DTS SURROUND	This mode can be selected when playing sources recorded in DTS.
DTS ES DSCRT6.1*1	This mode is suitable for playing discs recorded in DTS-ES. The surround back channel added using the discrete method is played as an independent channel. Since all channels are independent, the 360-degree spacial expressiveness and sound localization are enhanced.
DTS ES MTRX6.1*2	This mode is suitable for playing discs recorded in DTS-ES. The surround back channel added to the surround-left and surround-right channels by a matrix encoder at software recording time is decoded by this unit's matrix decoder and played from each channel (surround left, surround right, surround back).
DTS 96/24	This mode can be selected when playing sources recorded in DTS 96/24.
DTS-HD	This mode can be selected when playing sources recorded in DTS-HD.
DTS Express	This mode can be selected when playing sources recorded in DTS Express.

*1 This mode can be selected when only one surround back speaker is used and no front height speaker is used.

*2 This can be selected when "Speaker Config." – "Surr. Back" ( page 169) is not set to "None".

PCM multi-channel sound mode

Sound mode type	Description
MULTI CH IN	This mode can be selected when playing multi-channel PCM sources.



Original sound mode

Sound mode type	Description
MULTI CH STEREO	This mode is for enjoying stereo sound from all speakers. Stereo audio (2-channel) sources are played back via the front (L/R) speakers, the surround speakers and if connected the surround back speakers.
VIRTUAL	This mode lets you experience an expansive surround sound effect when playing back through just the front (L/R) speakers only, and when listening with stereo headphones.

AUTO sound mode

Sound mode type	Description
AUTO	In this mode, the type of digital signal input, such as Dolby Digital, Dolby TrueHD, Dolby Digital Plus, DTS, DTS-HD, PCM (multi-channel) is detected, and the playback mode switches automatically to the corresponding mode. If the input signal is analog or PCM (2-channel), stereo playback is used.



Stereo sound mode

Sound mode type	Description
STEREO	<p>This mode plays 2-channel stereo audio with no additional surround sound processing.</p> <ul style="list-style-type: none"> • Sound is output from the front left and right speakers, and subwoofer if connected. • When multi-channel signals are inputted, they are mixed down to 2-channel audio and are played back with no additional surround sound processing.

Direct sound mode

Sound mode type	Description
DIRECT	<p>This mode provides a direct input-to-output path with minimal audio processing, bypassing any unnecessary stages for purest sound.</p>
PURE DIRECT	<p>This mode provides the direct audio signal path benefit of the Direct mode along with disabling additional stages that might possibly have an affect on sound quality.</p> <p>In Pure Direct mode, the following elements are turned off:</p> <ul style="list-style-type: none"> • The front panel display and its driver circuitry are shut down. The display will temporarily come on when adjusting the volume, etc., but will turn off again once the adjustment has been made. • The analog video input/output switcher and processor is disabled.



■ Sound mode

- The following sound modes can be selected using the MOVIE, MUSIC, GAME, and PURE buttons.
- Adjust the sound field effect with the menu “Surround Parameter” (🔧 page 140) to enjoy surround sound the way you like it.

Input signal	Sound mode	NOTE	Sound mode		
			MOVIE	MUSIC	GAME
2-channel *1	STEREO		○	○	○
	DOLBY PLII/IIx Movie	*2	○		
	DOLBY PLII/IIx Music	*2		○	
	DOLBY PLII/IIx Game	*2			○
	DOLBY PLIIz	*2	○	○	○
	DTS NEO:6 Cinema	*2	○		
	DTS NEO:6 Music	*2		○	
	MULTI CH STEREO		○	○	○
VIRTUAL		○	○	○	

*1 2-channel also includes analog input.

*2 This mode plays back 2-channel sources in 5.1 or 7.1-channel playback. It cannot be selected when headphones are used, or when only front speakers are used.



Input signal	Sound mode	NOTE	Sound mode		
			MOVIE	MUSIC	GAME
Multi-channel *3	STEREO		<input type="radio"/>	<input type="radio"/>	<input type="radio"/>
	DOLBY DIGITAL		<input type="radio"/>	<input type="radio"/>	<input type="radio"/>
Dolby Digital	DOLBY DIGITAL EX		<input type="radio"/>	<input type="radio"/>	<input type="radio"/>
	DOLBY DIGITAL + PLIIx Movie		<input type="radio"/>		
	DOLBY DIGITAL + PLIIx Music			<input type="radio"/>	
	DOLBY DIGITAL + PLIIz		<input type="radio"/>	<input type="radio"/>	<input type="radio"/>
	DOLBY TrueHD		<input type="radio"/>	<input type="radio"/>	<input type="radio"/>
Dolby TrueHD	DOLBY TrueHD + EX		<input type="radio"/>	<input type="radio"/>	<input type="radio"/>
	DOLBY TrueHD + PLIIx Movie		<input type="radio"/>		
	DOLBY TrueHD + PLIIx Music			<input type="radio"/>	
	DOLBY TrueHD + PLIIz		<input type="radio"/>	<input type="radio"/>	<input type="radio"/>
	DOLBY DIGITAL Plus		<input type="radio"/>	<input type="radio"/>	<input type="radio"/>
Dolby Digital Plus	DOLBY DIGITAL Plus + EX		<input type="radio"/>	<input type="radio"/>	<input type="radio"/>
	DOLBY DIGITAL Plus + PLIIx Movie		<input type="radio"/>		
	DOLBY DIGITAL Plus + PLIIx Music			<input type="radio"/>	
	DOLBY DIGITAL Plus + PLIIz		<input type="radio"/>	<input type="radio"/>	<input type="radio"/>
	DTS SURROUND		<input type="radio"/>	<input type="radio"/>	<input type="radio"/>
DTS	DTS ES DSCRT 6.1		<input type="radio"/>	<input type="radio"/>	<input type="radio"/>
	DTS ES MTRX 6.1		<input type="radio"/>	<input type="radio"/>	<input type="radio"/>
	DTS 96/24		<input type="radio"/>	<input type="radio"/>	<input type="radio"/>
	DTS + PLIIx Movie		<input type="radio"/>		
	DTS + PLIIx Music			<input type="radio"/>	
	DTS + PLIIz		<input type="radio"/>	<input type="radio"/>	<input type="radio"/>
	DTS + NEO:6		<input type="radio"/>	<input type="radio"/>	<input type="radio"/>

*3 Some sound modes cannot be selected, depending on the audio format or number of channels of the input signal. For details, see "Types of input signals, and corresponding sound modes" (📖 page 213).



Input signal	Sound mode	NOTE	Sound mode		
			MOVIE	MUSIC	GAME
DTS-HD / DTS Express	DTS-HD HI RES		<input type="radio"/>	<input type="radio"/>	<input type="radio"/>
	DTS-HD MSTR		<input type="radio"/>	<input type="radio"/>	<input type="radio"/>
	DTS Express		<input type="radio"/>	<input type="radio"/>	<input type="radio"/>
	DTS-HD + PLIIx Movie		<input type="radio"/>		
	DTS-HD + PLIIx Music			<input type="radio"/>	
	DTS-HD + PLIIz		<input type="radio"/>	<input type="radio"/>	<input type="radio"/>
	DTS-HD + NEO:6		<input type="radio"/>	<input type="radio"/>	<input type="radio"/>
PCM multi-channel	MULTI CH IN		<input type="radio"/>	<input type="radio"/>	<input type="radio"/>
	MULTI CH IN 7.1		<input type="radio"/>	<input type="radio"/>	<input type="radio"/>
	MULTI IN + PLIIx Movie		<input type="radio"/>		
	MULTI IN + PLIIx Music			<input type="radio"/>	
	MULTI IN + PLIIz		<input type="radio"/>	<input type="radio"/>	<input type="radio"/>
	MULTI IN + NEO:6		<input type="radio"/>	<input type="radio"/>	<input type="radio"/>
Multi-channel *3	MULTI CH STEREO		<input type="radio"/>	<input type="radio"/>	<input type="radio"/>
	VIRTUAL		<input type="radio"/>	<input type="radio"/>	<input type="radio"/>

*3 Some sound modes cannot be selected, depending on the audio format or number of channels of the input signal. For details, see "Types of input signals, and corresponding sound modes" (page 213).



■ Views on the display

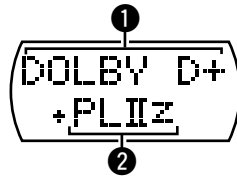

- ① Shows a decoder to be used.
 - A DOLBY DIGITAL Plus decoder is displayed as "DOLBY D+".
- ② Shows a decoder that creates sound output from the speakers.
 - "+ PLIIz" indicates the front height sound from front height speakers.



HDMI control function

A recent addition to the HDMI standard is CEC (Consumer Electronics Control), which allows control signals from one device to communicate with another device via the HDMI cable connection. Not all HDMI-equipped devices have this capability.

Setting procedure

1 Set the HDMI output connector corresponding with the HDMI control function.

Set "HDMI Control" (☞ [page 150](#)) to "On".

2 Turn the power on for all the devices connected by HDMI cable.

3 Set the HDMI control function for all devices connected by HDMI cable.

- Please consult the operating instructions for the connected devices to check the settings.
- Carry out steps 2 and 3 should any of the devices be unplugged.

4 Switch the television input to the HDMI input connected to this unit.

5 Switch this unit input to the HDMI input source and check if the picture from the player is ok.

6 When you turn the TV's power to standby, check that the power of this unit also goes to standby.

NOTE

- Some functions may not operate depending on the connected TV or player. Check the owner's manual of each device for details beforehand.



Sleep timer function

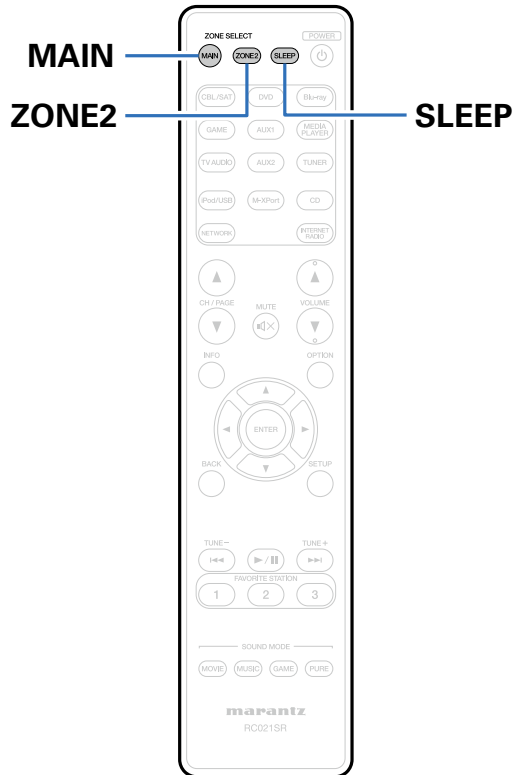

You can have the power automatically switched to standby once a set time has elapsed. This is convenient for viewing and listening while going to sleep.

The sleep timer function can be set for each zone.

Using the sleep timer

- 1 Press MAIN or ZONE2 to switch the zone mode.**
The button for the selected zone is lit.
- 2 Press SLEEP and display the time you want to set.**
The sleep timer indicator on the display lights.
 - You can set the sleep timer in the range from 10 to 120 minutes in steps of 10 minutes.

■ To cancel the sleep timer

Press SLEEP to set "Off".

The sleep timer indicator on the display turns off.



- The sleep timer is also cancelled when this unit is set to the standby mode or the MAIN ZONE or ZONE2 power is turned off.

NOTE

- The sleep timer function cannot turn off the power of devices connected to this unit. To turn off the power of those connected devices, set up sleep timers on the connected devices themselves.



Web control function

You can control this unit from a web control screen on a web browser.

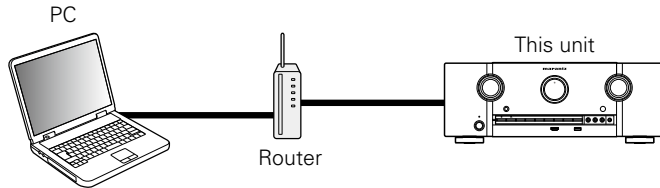

- This unit and the PC need to be connected to the network properly (☞ [page 45](#) “Connecting to a home network (LAN)”) in order to use the web control function.
- Depending on the settings of your security-related software, you may not be able to access this unit from your PC. If this is the case, then change the settings of the security-related software.

Controlling the unit from a web control

- 1 Switch the “IP Control” (☞ [page 173](#)) setting to “Always On”.
- 2 Check the IP address of this unit with “Information” (☞ [page 173](#)).

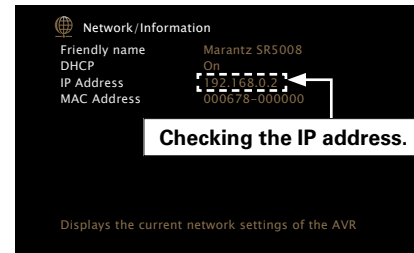

- 3 Start up the web browser.



4 Enter the IP address of this unit in browser's address box.

For example, if the IP address of this unit is "192.168.0.2", enter "http://192.168.0.2".

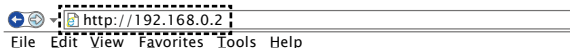

5 When the top menu is displayed, click on the menu item you want to operate.

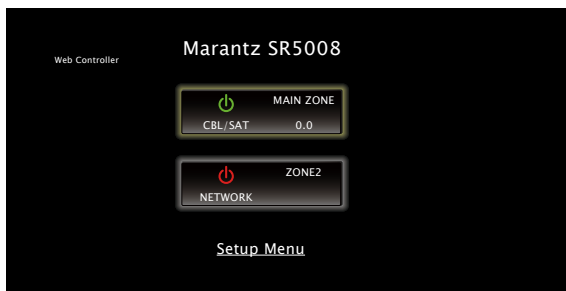

- You can use the Web control function with Internet Explorer 8 or later to memorize and call up various settings on this unit.
To memorize settings, click "SAVE" on the Setup Menu screen.
To call up settings, click "LOAD" on the Setup Menu screen.



Dual backup memory function

The unit stores settings information in nonvolatile memory even when the main power supply is turned off. Using the Dual Backup Memory function, you can write settings information to another memory area to back up saved settings for recovery anytime as needed. Remembering set details (Backup).

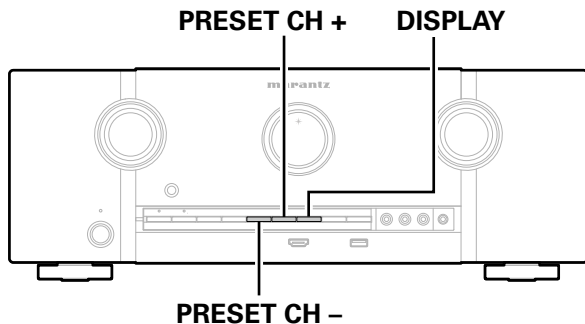

Remembering set details (Backup)

- 1 **Set the unit in the state you want remembering, and press and hold PRESET CH + and PRESET CH - for at least 3 seconds.**

"MEMORY SAVING" is shown in the display, and the setting details are remembered.



- The volume is not remembered.
- If remembered details are overwritten, the previously remembered contents are deleted.

Recalling remembered details (Recovery)

- 1 **Press and hold PRESET CH + and DISPLAY together for at least 3 seconds.**

"MEMORY LOAD" is shown in the display, and the remembered details are recalled.



- If there is no remembered data, "NO BACKUP" is shown in the display, and no remembered details are recalled.
- As the volume cannot be recalled, it returns to the factory setting volume.



Panel lock function

To prevent accidental operation of this unit, you can disable operation of the buttons on the front panel.

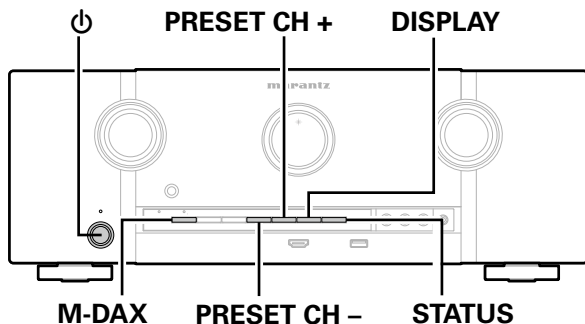

Disabling all key button operations

- 1** Press **⏻** while you press and hold **DISPLAY** and **M-DAX** with the unit in standby mode.
- 2** Press **PRESET CH +** or **PRESET CH -** to select "P/V LOCK On".
- 3** Press **STATUS** to enter the setting.
All button operations except **⏻** are disabled.

Disabling all button operations except VOLUME

- 1** Press **⏻** while you press and hold **DISPLAY** and **M-DAX** with the unit in standby mode.
- 2** Press **PRESET CH +** or **PRESET CH -** to select "FP LOCK On".
- 3** Press **STATUS** to enter the setting.
All button operations except **⏻** and **VOLUME** are disabled.



Canceling the Panel lock function

- 1 Press  while you press and hold DISPLAY and M-DAX with the unit in standby mode.**
- 2 Press PRESET CH + or PRESET CH – to select “FP LOCK *Off”.**
(* The currently set mode.)
- 3 Press STATUS to enter the setting.**
The Panel lock function is canceled.



- Even when the Panel lock function is set, you can operate the unit using the remote control unit.



Remote lock function

When connecting an IR receiver, enable the Remote lock function. When the function is enabled, you can not perform operations with the remote control unit.

By default, this function is disabled.

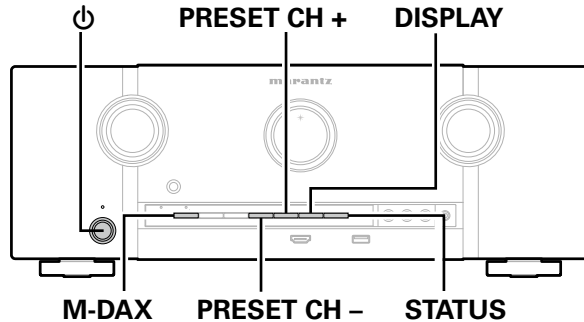

Disabling the sensor function of the remote control unit

- 1 When the main unit is in standby mode, press **⏻** while holding down **DISPLAY** and **M-DAX** on the main unit.
- 2 Press **PRESET CH +** or **PRESET CH -** to select "RC LOCK On".
- 3 Press **STATUS** to enter the setting.
The infrared light receiving function is disabled.

Enabling the remote sensor function

- 1 When the main unit is in standby mode, press **⏻** while holding down **DISPLAY** and **M-DAX** on the main unit.
- 2 Press **PRESET CH +** or **PRESET CH -** to select "RC LOCK *Off".
(* The currently set mode.)
- 3 Press **STATUS** to enter the setting.
The infrared light receiving function on the main unit is enabled.



Playback in ZONE2 (Separate room)

You can operate this unit to enjoy audio in a room (ZONE2) that is different from the room where this unit is placed (MAIN ZONE). You can simultaneously play back the same source in both the MAIN ZONE and ZONE2. You can also play back separate sources in the MAIN ZONE and ZONE2.

Connecting ZONE2

You can use the following two methods to play back audio in ZONE2.

- Connection through the speaker output terminals (👉 [page 127](#))
- Connection using an external amplifier (👉 [page 128](#))

■ Connection 1 : Connection through the speaker output terminals

- Set the “Assign Mode” (👉 [page 167](#)) setting to “ZONE2”, and outputs ZONE2 audio from SURROUND BACK speaker terminals.
- If you set the “Assign Mode” (👉 [page 167](#)) setting to “ZONE2”, the main zone home theater system can play back up to 5.1-channels. Even if you play back audio recorded in 6.1 or 7.1-channels, this unit automatically downmixes the audio to 5.1-channels.

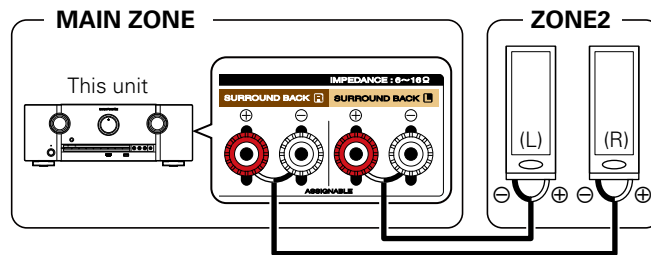

■ Connection 2 : Connection using an external amplifier

The audio signals of this unit's ZONE2 audio output connectors are output to the ZONE2 amplifiers and played on these amplifiers.

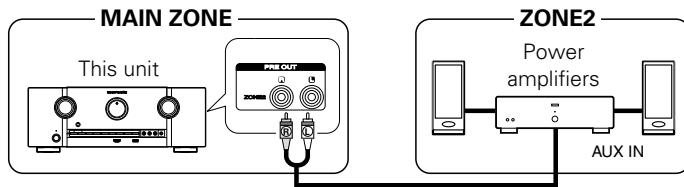

- We recommend using high quality pin-plug (RCA type) cables for audio connections in order to prevent noise.
- If you select a same input source for MAIN ZONE and ZONE2, audio playback may be restricted.



Playback in ZONE2

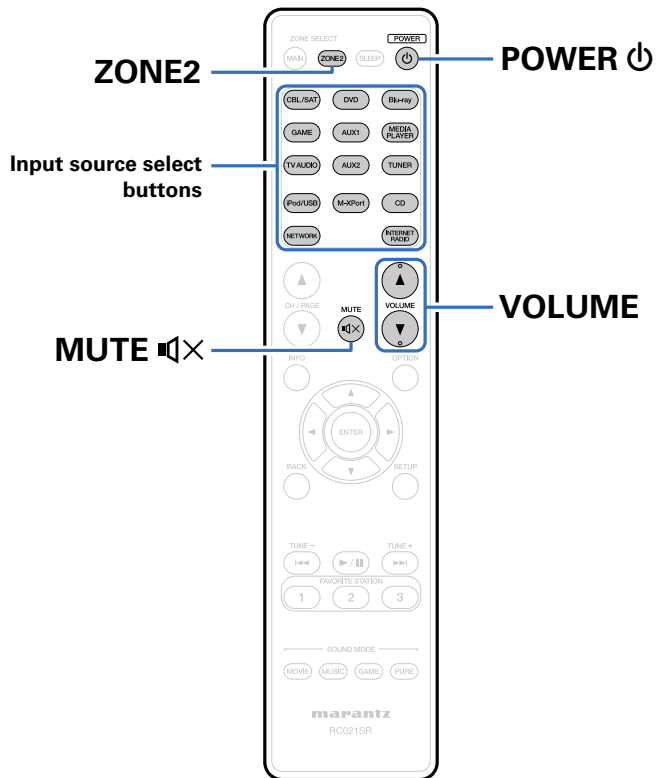

1 Press ZONE2 to switch the zone mode to the ZONE2.

2 Press POWER to turn on the ZONE2 power.

The ZONE2 power indicator on the display lights ([see page 15](#)).

- Also press input source select button when in standby mode, the power turns on.
- When POWER is pressed, ZONE2 turns off.
- Power in ZONE2 can be turned on or off by pressing ZONE2 ON/OFF on the main unit.

3 Press the input source select button to select the input source to be played.

The audio signal of the selected source is output to ZONE2.

- In ZONE2, you can select iPod/USB, TUNER, NETWORK, M-XPort or an input source with an analog audio input connector.
- Turn INPUT SELECTOR after pressing ZONE2 SOURCE on the main unit to select an input source.

■ Adjusting the volume

Use VOLUME to adjust the volume.

- At time of purchase, "Volume Limit" ([see page 178](#)) is set to "70 (-10dB)".





- Turn VOLUME after pressing ZONE2 SOURCE on the main unit to adjust the sound volume.



■ Turning off the sound temporarily

Press MUTE .

The sound is reduced to the level set at “Mute Level” ( page 178) in the menu.

- To cancel, either adjust the volume or press MUTE  again.
- You can also adjust the volume level to cancel the muting.



Settings

Menu map

For menu operation, connect a TV to this unit and display the menu on the TV screen. For menu operations, see the following page. By default, this unit has recommended settings defined. You can customize this unit based on your existing system and your preferences.

■ Audio

Setting items	Description	Page
Dialog Level	Sets the output level to clarify the dialogue output from the center channel.	139
Subwoofer Level	This setting adjusts the volume level for the subwoofer.	139
Subwoofer	Turn subwoofer output on and off.	139
Subwoofer Level	This setting adjusts the volume level for the subwoofer.	139
Surround Parameter	Adjusts surround sound parameters.	140
Home Theater EQ	Gently softens the upper treble range of movie soundtracks to reduce possible harshness and improve clarity.	140
Loudness Management	This sets whether to output as specified in "Dynamic Compression" or output directly without compressing the dynamic range of audio recorded in the disc.	140
Dynamic Compression	Compress dynamic range (difference between loud and soft sounds).	140
Low Frequency Effects	Adjust the low frequency effects level (LFE).	141
Center Image	Distributes the dialogue output from the center channel to the front left and right channels and widens the sound image in the front.	141
Panorama	Assign front L/R signals to also go to the surround channels for wider sound.	141
Dimension	Shift sound image center to front or rear to adjust playback balance.	141
Center Width	Distributes the dialogue output from the center channel to left and right channels and widens the sound image in the front.	142
Height Gain	Control the front height channel volume.	142



Setting items	Description	Page
Tone	Adjusts the tonal quality of the sound.	143
Tone Control	Set the tone control function to "On" and "Off".	143
Bass	Adjust bass.	143
Treble	Adjust treble.	143
M-DAX	Expands the low and high frequency components of compressed audio content such as MP3 files to enable richer audio playback.	143
Audio Delay	Compensates for incorrect timing between video and audio.	144
Volume	Set the MAIN ZONE (room where the unit is located) volume setting.	144
Scale	Set how volume is displayed.	144
Limit	Make a setting for maximum volume.	144
Power On Level	Define the volume setting that is active when the power is turned on.	144
Mute Level	Set the amount of attenuation when muting is on.	144
Audyssey	Makes Audyssey MultEQ® XT, Audyssey Dynamic EQ® and Audyssey Dynamic Volume® settings.	145
MultEQ® XT	MultEQ® XT compensates for both time and frequency characteristics of the listening area based on Audyssey® Setup measurement results.	145
Dynamic EQ	Solves the problem of deteriorating sound quality as volume is decreased by taking into account human perception and room acoustics. Works with MultEQ® XT.	145
Reference Level Offset	Audyssey Dynamic EQ® is referenced to the standard film mix level.	146
Dynamic Volume	Solves the problem of large variations in volume level between TV, movies and other content (between quiet passages and loud passages, etc.) by automatically adjusting to the user's preferred volume setting.	146
Graphic EQ	Uses the graphic equalizer to adjust the tone of each speaker.	147
Speaker Selection	Select whether to adjust tones for individual speakers or for all speakers.	147
Adjust EQ	Adjust tonal balance for each frequency band. Adjust the speaker selected in "Speaker Selection".	147
Curve Copy	Copy "Audyssey Flat" curve from MultEQ® XT.	147



■ Video

Setting items	Description	Page
Picture Adjust	Adjusts the video quality.	148
Picture Mode	Select the desired picture mode according to the video content and your viewing environment.	148
Contrast	Adjust picture contrast.	148
Brightness	Adjust picture brightness.	148
Saturation	Adjust picture chroma level (color saturation).	148
Hue	Adjust green and red balance. Also called Tint.	148
Noise Reduction	Reduce overall video noise.	149
Enhancer	Emphasize picture sharpness.	149
HDMI Setup	Makes settings for HDMI video/audio output.	149
Auto Lip Sync	Make automatic compensation for timing shift in audio and video output.	149
HDMI Audio Out	Select HDMI audio output device.	150
HDMI Pass Through	Selects how the AV receiver will pass HDMI signals to the HDMI output in standby power mode.	150
HDMI Control	You can link operations with devices connected to HDMI and compatible with HDMI Control.	150
Pass Through Source	The AV receiver will “pass through” the sources HDMI signal when in standby.	150
Power Off Control	Links the power standby of this unit to external devices.	150
Output Settings	Makes screen-related settings.	151
Video Mode	Make settings for video processing.	151
Video Conversion	The input video signal is converted automatically in conjunction with the connected TV.	151
i/p Scaler	Convert the input source resolution to the resolution set.	151
Resolution	Set the output resolution.	152
Progressive Mode	Set an appropriate progressive conversion mode for the source video signal.	152
Aspect Ratio	Set the aspect ratio for the video signals output to the HDMI.	152
On Screen Display	Select the on-screen display user interface preferences.	153
Volume	Sets where to display the master volume level.	153
Info	Displays status of operation temporarily when the sound mode is changed, or input source is switched.	153
Now Playing	Sets how long each menu is displayed when the input source is “NETWORK”, “iPod/USB”, or “TUNER”.	153
TV Format	Set the video output signal format for the TV you are using.	153



■ Inputs

Setting items	Description	Page
Input Assign	Changes input connector assignment.	154
Source Rename	Changes the display name for this source.	156
Hide Sources	Remove from the display input sources that are not used.	156
Source Level	Adjusts the playback level of the audio input.	156
Input Select	Sets the audio input mode and decode mode.	157
Input Mode	Set the audio input modes for the different input sources.	157
Decode Mode	Set the audio decode mode for input source.	157

■ Speakers

Setting items	Description	Page
Audyssey® Setup	The acoustic characteristics of the connected speakers and listening room are measured and the optimum settings are made automatically.	158
Manual Setup	Perform when setting the speakers manually or when changing settings made in Audyssey® Setup.	167
Amp Assign	Select power amplifier usage method to match your speaker system.	167
Speaker Config.	Indicate speaker presence and select speaker size categories based on bass reproduction capability.	168
Distances	Set distance from listening position to speakers.	170
Levels	Set the volume of the test tone to be the same when it is output from each speaker.	170
Crossovers	Set the maximum frequency of the bass signal output from each channel to the subwoofer.	171
Bass	Set subwoofer and LFE signal range playback.	172
Front Speaker	Set the front speakers to use for every sound mode.	172



■ Network

Setting items	Description	Page
Information	Display network information.	173
IP Control	Enables network communication in standby power mode.	173
Friendly Name	The Friendly Name is the name of this unit displayed on the network. You can change the Friendly Name according to your preferences.	173
Settings	Make settings for wired LAN.	174
Diagnostics	Used to check the network connection.	175
Maintenance Mode	Use when receiving maintenance from a Marantz service engineer or custom installer.	176

■ General

Setting items	Description	Page
Language	Sets the language for display the menu on the TV screen.	177
ZONE2 Setup	Makes settings for audio playback in a ZONE2 system.	177
Lch Level	Adjust the left channel output level.	177
Rch Level	Adjust the right channel output level.	177
Volume Level	Set the volume output level.	177
Volume Limit	Make a setting for maximum volume.	178
Power On Volume	Define the volume setting that is active when the power is turned on.	178
Mute Level	Set the amount of attenuation when muting is on.	178
Zone Rename	Change the display title of each zone to one you prefer.	178
Auto Standby	When you do not perform any operation on this unit with no audio or video input for a specified time, this unit automatically enters the standby mode. Before it enters the standby mode, "Auto Standby" is displayed on the display of this unit and the menu screen.	179
Front Display	Makes settings related to the display on this unit.	179



Setting items	Description	Page
Information	Show information about receiver settings, input signals, etc.	179
Audio	Shows information about audio input signals.	179
Video	Shows information about video input signal and HDMI Monitor.	180
ZONE	Shows information about each zone.	180
Firmware	Displays system information.	180
Notifications	Selects notification message preferences.	180
Usage Data	Selects whether or not to send anonymous usage data to Marantz.	181
Firmware	Set whether or not to check for firmware update, update the firmware, and display update and upgrade notifications.	181
Update	Update the firmware of the receiver.	181
Notifications	Displays a notification message on this unit's menu screen when the latest firmware is released with "Update".	182
Add New Feature	Display new features that can be downloaded to this unit and perform an upgrade.	182
Setup Lock	Protect settings from inadvertent changes.	183

■ Setup Assistant

Setting items	Description	Page
Begin Setup	Perform basic installation/connections/settings from the beginning according to the guidance indicated on the TV screen.	 7
Language Select	Perform settings item by item according to the guidance indicated on the TV screen.	
Speaker Setup		
Speaker Calibration		
Network Setup		
Input Setup		



Menu operation

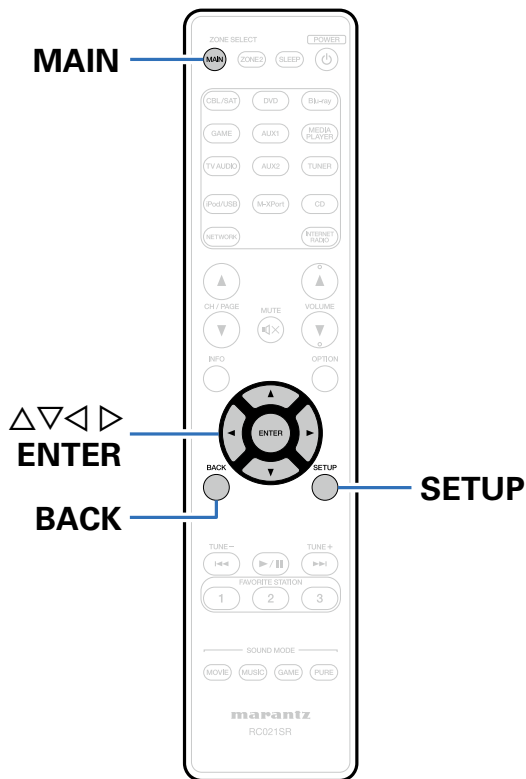

- 1 Press MAIN to switch the zone mode.**
MAIN lights.
- 2 Press SETUP.**
The menu is displayed on the TV screen.
- 3 Use $\Delta \nabla \triangleleft \triangleright$ to select the menu to be set or operated, then press ENTER.**
- 4 Use $\triangleleft \triangleright$ to change to desired setting.**
- 5 Press ENTER to enter the setting.**
 - To return to the previous item, press BACK.
 - Exiting the Menu, press SETUP while the menu is displayed. The menu display disappears.



Inputting characters

On this unit, you can change the name displayed on the following screens to the names that you prefer.

- Preset Name (🔗 page 66)
- Text Search (🔗 page 102)
- Source Rename (🔗 page 156)
- Friendly Name (🔗 page 173)
- Zone Rename (🔗 page 178)
- Character input for the network functions (🔗 page 69, 76, 80, 87, 90, 174)

Keyboard screen

1 Display the screen for inputting characters.

[Example] Source Rename screen



2 Select a character to be changed.

- ① Use $\Delta \nabla \triangleleft \triangleright$ to select “←” or “→”.
- ② Press ENTER to place the cursor at the character to be changed.

Each time ENTER is pressed, the cursor moves by one character.

3 Select a character to be input with $\Delta \nabla \triangleleft \triangleright$ then press ENTER.

4 Repeat steps 2 and 3 to change the name.

5 Use $\Delta \nabla \triangleleft \triangleright$ to select “OK”, then press ENTER.



Audio

Make audio-related settings.

Dialog Level

Sets the output level to clarify the dialogue output from the center channel.

■ Level

-12.0dB – +12.0dB (Default : 0.0dB)

Subwoofer Level

This setting adjusts the volume level for the subwoofer.

■ Subwoofer

Turn subwoofer output on and off.

On (Default) : The subwoofer is used.

Off : The subwoofer is not used.



- This can be set when the sound mode is "DIRECT" and the "Subwoofer Mode" (see page 172) is "LFE+Main".

■ Subwoofer Level

This setting adjusts the volume level for the subwoofer.

-12.0dB – +12.0dB (Default : 0.0dB)



Surround Parameter

You can adjust the surround audio sound field effects to match your preferences.

The items (parameters) that can be adjusted depend on the signal being input and the currently set sound mode. For details on the adjustable parameters, see “Sound modes and surround parameters” (🔍 page 210).



- Some setting items cannot be set while playback is stopped. Make the settings during playback.

■ Home Theater EQ

Gently softens the upper treble range of movie soundtracks to reduce possible harshness and improve clarity.

On : “Home Theater EQ” is used.

Off (Default) : “Home Theater EQ” is not used.

■ Loudness Management

This sets whether to output as specified in “Dynamic Compression” or output directly without compressing the dynamic range of audio recorded in the disc.

On (Default) : Outputs using the settings made in “Dynamic Compression” and “Dialogue normalization function” (🔍 page 179) are enabled.

Off : “Dynamic Compression” settings and “Dialogue Normalization” are disabled, and the signals on the disk are output as is.



- This can be set in the Dolby TrueHD mode.

■ Dynamic Compression

Compress dynamic range (difference between loud and soft sounds).

Auto (Default) : Automatic dynamic range compression on/off control according to source.

Low / Medium / High : These set the compression level.

Off : Dynamic range compression is always off.



- You can set “Auto” only for the Dolby TrueHD source.



■ Low Frequency Effects

Adjust the low-frequency effects level (LFE).

❑ When "Input Mode" is set other than "7.1CH IN"

-10dB – 0dB (Default)

❑ When "Input Mode" is set to "7.1CH IN"

0dB / +5dB / +10dB (Default) / **+15dB**



- For proper playback of the different sources, we recommend setting to the values below.
 - Dolby Digital sources : 0dB
 - DTS movie sources : 0dB
 - DTS music sources : -10dB

■ Center Image

Distributes the dialogue output from the center channel to the front left and right channels and widens the sound image in the front.

0.0 – 1.0 (Default : 0.3)



- You can set this when the sound mode is set to DTS NEO:6 Music.
- The smaller the value, the more dialogue is concentrated on the center channel. The larger the value, the more dialogue is distributed to front left and right channels, and the more the sound image widens in the front.

■ Panorama

Assign front L/R signals to also go to the surround channels for wider sound.

On : Set.

Off (Default) : Do not set.



- You can set this when the sound mode is Dolby PLII/IIx in the "Music" mode.

■ Dimension

Shift sound image center to front or rear to adjust playback balance.

0 – 6 (Default : 3)



- You can set this when the sound mode is Dolby PLII/IIx in the "Music" mode.
- As you set a smaller number, the surround sound field shifts backward; as you set a larger number, the surround sound field shifts forward.



■ Center Width

Distributes the dialogue output from the center channel to left and right channels and widens the sound image in the front.

0 – 7 (Default : 3)



- You can set this when the sound mode is Dolby PLII/IIx in the “Music” mode.
- The smaller the value, the more dialogue is concentrated on the center channel. The larger the value, the more dialogue is distributed to front left and right channels, and the more the sound image widens in the front.

■ Height Gain

Control the front height channel volume.

Low : Reduce the front height channel volume.

Normal (Default) : Front height channel sound is output with standard sound volume.

High : Increase the front height channel volume.



- You can set this in the “PLIIz” sound mode or when using the PLIIz decoder.

■ Set Defaults

The “Surround Parameter” settings are returned to the default settings.



Tone

Adjust the tonal quality of the sound.

■ Tone Control

Set the tone control function to “On” and “Off”.

On : Allow tone adjustment (bass, treble).

Off (Default) : Playback without tone adjustment.

■ Bass

Adjust bass.

-6dB – +6dB (Default : 0 dB)

■ Treble

Adjust treble.

-6dB – +6dB (Default : 0 dB)



- This cannot be set when the sound mode is set to “DIRECT” or “PURE DIRECT”.

M-DAX

Compressed audio formats such as MP3, WMA (Windows Media Audio) and MPEG-4 AAC reduce the amount of data by eliminating signal components that are hard for the human ear to hear. The “M-DAX” function generates the signals eliminated upon compression, restoring the sound to conditions near those of the original sound before compression. It also restores the original bass characteristics for a rich and expanded tonal range.

■ Mode

Set the mode for “M-DAX”.

High : Optimized mode for compressed sources with very weak highs (64 kbps and under).

Medium : Apply suitable bass and treble boost for all compressed sources (96 kbps and under).

Low : Optimized mode for compressed sources with normal highs (96 kbps and over).

Off (Default) : Do not use “M-DAX”.



- This item can be set with analog signals or PCM signal (Sample Rate = 44.1/48 kHz) is input.
- “M-DAX” settings are stored for each input source.
- This cannot be set when the sound mode is set to “DIRECT” or “PURE DIRECT”.
- This can also be set by pressing M-DAX on the main unit.
- The M-DAX indicator lights.



Audio Delay

While viewing video, manually adjust the time to delay audio output so that the video and audio are synchronized.

0ms (Default) – **200ms**



- This item can be set within the range of 0 to 100 ms when “Auto Lip Sync” (🔗 [page 149](#)) is set to “On” and when a TV compatible with Auto Lip Sync is connected.
- Store “Audio Delay” for each input source.
- Audio Delay for game mode can be set when “Video Mode” (🔗 [page 151](#)) is set to “Auto” or “Game”.

Volume

Set the MAIN ZONE (room where the unit is located) volume setting.

■ Scale

Set how volume is displayed.

0 – 98 (Default) : Display in the range 0 (Min) to 98.

–79.5dB – 18.0dB : Display –dB (Min), in the range –79.5 dB to 18.0 dB.



- The “Scale” setting applies to all zones.

■ Limit

Make a setting for maximum volume.

60 (–20dB) / 70 (–10dB) / 80 (0dB)

Off (Default)

■ Power On Level

Define the volume setting that is active when the power is turned on.

Last (Default) : Use the memorized setting from the last session.

Mute : Always use the muting on condition when power is turned on.

1 – 98 (–79dB – 18dB) : The volume is adjusted to the set level.

■ Mute Level

Set the amount of attenuation when muting is on.

Full (Default) : The sound is muted entirely.

–40dB : The sound is attenuated by 40 dB down.

–20dB : The sound is attenuated by 20 dB down.



Audyssey

Set Audyssey MultEQ® XT, Audyssey Dynamic EQ® and Audyssey Dynamic Volume®. These can be selected after Audyssey® Setup has been performed. For additional information on Audyssey technology, please see [page 216](#).



- “MultEQ® XT”, “Dynamic EQ” and “Dynamic Volume” settings are stored for each input source.
- “MultEQ® XT”, “Dynamic EQ” and “Dynamic Volume” cannot be set when the sound mode is set to “DIRECT” or “PURE DIRECT”.

■ MultEQ® XT

MultEQ® XT compensates for both time and frequency characteristics of the listening area based on Audyssey® Setup measurement results. Selection is done from three types of compensation curves. We recommend the “Audyssey” setting.

Audyssey (Default) : Optimize the frequency response of all speakers.

Audyssey Byp. L/R : Optimize frequency response of speakers except front L and R speakers.

Audyssey Flat : Optimize frequency response of all speakers to flat response.

Graphic EQ : Apply frequency response set with “Graphic EQ” ([page 147](#)).

Off : Turn “MultEQ® XT” equalizer off.



- When using headphones, “MultEQ® XT” is automatically set to “Off”.

■ Dynamic EQ

Solves the problem of deteriorating sound quality as volume is decreased by taking into account human perception and room acoustics. Works with MultEQ® XT.

On (Default) : Use Dynamic EQ.

Off : Do not use Dynamic EQ.



- When the menu “Dynamic EQ” setting is “On”, it is not possible to do “Tone Control” ([page 143](#)) adjustment.



■ Reference Level Offset

Audyssey Dynamic EQ® is referenced to the standard film mix level. It makes adjustments to maintain the reference response and surround envelopment when the volume is turned down from 0 dB. However, film reference level is not always used in music or other non-film content. Dynamic EQ Reference Level Offset provides three offsets from the film level reference (5 dB, 10 dB, and 15 dB) that can be selected when the mix level of the content is not within the standard. Recommended setting levels are shown at below.

0dB (Film Ref) (Default) : This is the default setting and should be used when listening to movies.

5dB : Select this setting for content that has a very wide dynamic range, such as classical music.

10dB : Select this setting for jazz or other music that has a wider dynamic range. This setting should also be selected for TV content as that is usually mixed at 10 dB below film reference.

15dB : Select this setting for pop/rock music or other program material that is mixed at very high listening levels and has a compressed dynamic range.



- Setting is enabled when “Dynamic EQ” ([page 145](#)) is “On”.

■ Dynamic Volume

Solves the problem of large variations in volume level between TV, movies and other content (between quiet passages and loud passages, etc.) by automatically adjusting to the user’s preferred volume setting.

Heavy : Most adjustment to softest and loudest sounds.

Medium : Medium adjustment to loudest and softest sound.

Light : Least adjustment to loudest and softest sounds.

Off (Default) : Do not use “Dynamic Volume”.



- If “Dynamic Volume” is set to “Yes” in “Audyssey® Setup” ([page 158](#)), the setting is automatically changed to “Medium”.



Graphic EQ

Use the 9 band graphic equalizer to adjust the tone of each speaker.



- “Graphic EQ” can be set when “MultEQ® XT” (page 145) setting is “Graphic EQ”.
- Speakers for which “Graphic EQ” can be set differ according to the sound mode.

■ Speaker Selection

Select whether to adjust tones for individual speakers or for all speakers.

All

Left/Right (Default)

Each

■ Adjust EQ

Adjust tonal balance for each frequency band. Adjust the speaker selected in “Speaker Selection”.

- ① Select the speaker.
- ② Select the adjustment frequency band.
63Hz / 125Hz / 250Hz / 500Hz / 1kHz / 2kHz / 4kHz / 8kHz / 16kHz
- ③ Adjust the level.
-20.0dB – +6.0dB (Default : 0.0dB)

■ Curve Copy

Copy “Audyssey Flat” curve from “MultEQ® XT” (page 145).



- “Curve Copy” is displayed after Audyssey® Setup has been performed.

■ Set Defaults

The “Graphic EQ” settings are returned to the default settings.



Video

Make video-related settings.

Picture Adjust

Picture quality can be adjusted.



- Can be set when the “Video Conversion” (🔗 page 151) setting is “On”.
- Can be set when “HDMI”, “COMP” or “VIDEO” (🔗 page 155) is assigned for each input source.

Picture Mode

Select the desired picture mode according to the video content and your viewing environment.

Standard : The standard mode suited for most living room viewing environments.

Movie : A mode suited for watching movies in a dark room such as a theater room.

Vivid : A mode that makes graphic images for games, etc. brighter and more vivid.

Streaming : A mode suited for low bit rate video sources.

Custom : Adjusts the picture quality manually.

Off : No picture quality adjustment is done with this unit.



- You can also press OPTION to make these settings from “Picture Mode” (🔗 page 105) in the option menu.
- The default settings are as follows.
 - For “NETWORK” and “iPod/USB” input sources : Streaming
 - For input sources other than “Network” and “iPod/USB” : Off

Contrast

Adjust picture contrast.

-6 – +6 (Default : 0)

Brightness

Adjust picture brightness.

0 – +12 (Default : 0)

Saturation

Adjust picture chroma level (color saturation).

-6 – +6 (Default : 0)

Hue

Adjust green and red balance. Also called Tint.

-6 – +6 (Default : 0)



■ Noise Reduction

Reduce overall video noise.

Low / Medium / High / Off (Default)

■ Enhancer

Emphasize picture sharpness.

0 (Default) – **+12**



- “Contrast”, “Brightness”, “Saturation”, “Hue”, “Noise Reduction” and “Enhancer” can be set when “Picture Mode” is set to “Custom”.
- “Picture Adjust” can not be set when 4K signals are input.

HDMI Setup

Make settings for HDMI video/audio output.

NOTE

- When “HDMI Pass Through” and “HDMI Control” is set to “On”, it consumes more standby power. If you are not using this unit for an extended period, it is recommended that you unplug the power cord from the power outlet.

■ Auto Lip Sync

Make automatic compensation for timing shift in audio and video output.

On (Default) : Compensated.

Off : Not compensated.

■ HDMI Audio Out

Select HDMI audio output device.

AVR (Default) : Play back through speakers connected to the unit.

TV : Play back through TV connected to the unit.



- When the HDMI control function is activated, priority is given to the TV audio setting (see page 119 “HDMI control function”).
- When the power of this unit is on and “HDMI Audio Out” is set to “TV”, audio is output as 2-channel from the HDMI OUT connector.



■ HDMI Pass Through

Selects how the AV receiver will pass HDMI signals to the HDMI output in standby power mode.

On (Default) : Passes the selected HDMI input through the AV receiver's HDMI output when the AV receiver is in standby power mode.

Off : No HDMI signals are passed through the AV receiver's HDMI output in standby power mode.

■ HDMI Control

You can link operations with devices connected to HDMI and compatible with HDMI Control.

On : Use HDMI control function.

Off (Default) : Do not use HDMI control function.



- Please consult the operating instructions for each connected device to check the settings.
- Refer to "HDMI control function" ([page 119](#)) for more information about the HDMI control function.

NOTE

- If the "HDMI Control" settings have been changed, always reset the power to connected devices after the change.

■ Pass Through Source

The AV receiver will "pass through" the sources HDMI signal when in standby.

Last : Choose this option to "pass through" the last used HDMI input video source.

CBL/SAT (Default) / **DVD** / **Blu-ray** / **GAME** / **AUX1** / **AUX2** / **MEDIA PLAYER** / **CD*** : Choose one of these HDMI sources to be passed through when the AV receiver is in standby.

* "Pass Through Source" can be set when any of the HDMI connectors is assigned to "CD" for the input source in the "Input Assign" ([page 154](#)) setting.



- "Pass Through Source" can be set when "HDMI Control" is set to "On" or "HDMI Pass Through" is set to "On".

■ Power Off Control

Links the power standby of this unit to external devices.

All (Default) : If power to a connected TV is turned off independently of the input source, power to this unit is automatically set to standby.

Video : With an input source being selected that is assigned either "HDMI", "COMP" or "VIDEO" ([page 155](#)), when you turn the power of the TV off, power to this unit is automatically set to standby.

Off : This unit does not link with power to a TV.



Output Settings

Makes screen-related settings.



- Can be set when each input source is assigned “HDMI”, “COMP” or “VIDEO” (☞ [page 155](#)).
- “Resolution”, “Progressive Mode” and “Aspect Ratio” can be set when “i/p Scaler” is set to anything other than “Off”.
- “Output Settings” can not be set when 4K signals are input.

■ Video Mode

Make settings for video processing.

Auto (Default) : Process video automatically based on the HDMI content information.

Game : Always process video for game content.

Movie : Always process video for movie content.



- If “Video Mode” is set to “Auto”, the mode is switched according to the input contents.

■ Video Conversion

The input video signal is converted automatically in conjunction with the connected TV (☞ [page 204](#) “Video conversion function”).

On (Default) : The input video signal is converted.

Off : The input video signal is not converted.

■ i/p Scaler

Convert the input source resolution to the resolution set.

- ☐ **When the input source is set other than to “iPod/USB” and “NETWORK”**

Analog (Default) : Use i/p (interlace-to-progressive) scaler function for analog video signals.

Analog & HDMI : Use i/p scaler function for analog and HDMI video signal.

HDMI : Use i/p scaler function for HDMI video signals.

Off : Do not use i/p scaler function.

- ☐ **When the input source is set to “iPod/USB” and “NETWORK”**

On (Default) : Use i/p scaler function.

Off : Do not use i/p scaler function.



- “Analog & HDMI” can be set for input sources for which an HDMI input connector is assigned.
- Which items can be set depend on the input source assigned to each input connector.
- This function is not effective when the input signal is “x.v.Color”, 3D, sYCC 601 color, Adobe RGB color, Adobe YCC 601 color or computer resolutions.



Resolution

Set the output resolution.

You can set "Resolution" separately for HDMI output of the analog video input and HDMI input.

Auto (Default) : The number of pixels the TV connected to the HDMI MONITOR OUT connector supports is detected automatically and the appropriate output resolution is set.

480p/576p / 1080i / 720p / 1080p / 1080p:24Hz / 4K :

Set the output resolution.



- When "i/p Scaler" is set to "Analog & HDMI", the resolution of both the analog video input signal and HDMI input signal can be set.
- When set to "1080p:24Hz", you can enjoy film-like pictures for film sources (in 24 Hz). For video sources and mixed sources, we recommend setting the resolution to "1080p".
- It is not possible to convert a 50 Hz signal into 1080p/24Hz. It is output at a resolution of 1080p/50Hz.

Progressive Mode

Set an appropriate progressive conversion mode for the source video signal.

Auto (Default) : The video signal is automatically detected and the appropriate mode is set.

Video : Select mode suitable for video playback.

Video and Film : Select mode suitable for video and 30-frame film material playback.



- This item can be set when "i/p Scaler" is set to anything other than "Off".

Aspect Ratio

Set the aspect ratio for the video signals output to the HDMI.

16:9 (Default) : Output at 16:9 aspect ratio.

4:3 : Output at 4:3 aspect ratio with black bars on the sides of a 16:9 TV screen (except for 480p/576p output).



- "Aspect Ratio" can be set when "i/p Scaler" is set to anything other than "Off".



On Screen Display

Select the on-screen display user interface preferences.

■ Volume

Sets where to display the master volume level.

Bottom (Default) : Display at the bottom.

Top : Display at the top.

Off : Turn display off.



- When the master volume display is hard to see when superimposed text (closed captioning) or movie subtitles are present, set to “Top”.

■ Info

Displays status of operation temporarily when the sound mode is changed, or input source is switched. You can set whether or not to show each of these status displays.

On (Default) : Turn display on.

Off : Turn display off.

■ Now Playing

Sets how long each menu is displayed when the input source is “NETWORK”, “iPod/USB”, or “TUNER”.

Always On (Default) : Show display continuously.

Auto Off : Show display for 30 seconds after operation.

TV Format

Set the video signal format to be output for the TV you are using.

■ Format

NTSC (Default) : Select NTSC output.

PAL : Select PAL output.



- “Format” can also be set by the following procedure. However, the menu screen is not displayed.
 1. Press and hold the main unit’s ZONE2 SOURCE and STATUS for at least 3 seconds.
“Video Format <NTSC>” appears on the display.
 2. Use the main unit’s PRESET CH +, – and set the video signal format.
 3. Press the main unit’s STATUS to complete the setting.

NOTE

- When a format other than the video format of the connected TV is set, the picture will not be displayed properly.



Inputs

Perform settings related to input source playback.

You do not have to change the settings to use the unit. Make settings when needed.

Input Assign

By making connections as indicated by the input sources printed on the audio/video input connectors of this unit, you can just press one of the input source select buttons to easily play back audio or video from a connected device.

When making connections other than the default settings, you must change settings in this section.

■ Examples of “Input Assign” menu screen displays

Use the “Input Assign” menu to change the HDMI input connectors, Digital input connectors, Analog input connectors, Component input connectors, and Video input connectors that are assigned to the input sources in default settings.

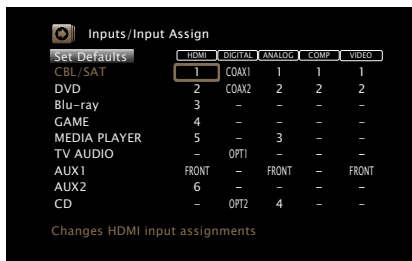

- By default, each item is set as follows.

Input source	HDMI	DIGITAL	ANALOG	COMP	VIDEO
CBL/SAT	1	COAX1	1	1	1
DVD	2	COAX2	2	2	2
Blu-ray	3	-	-	-	-
GAME	4	-	-	-	-
MEDIA PLAYER	5	-	3	-	-
TV AUDIO	-	OPT1	-	-	-
AUX1	FRONT	-	FRONT	-	FRONT
AUX2	6	-	-	-	-
CD	-	OPT2	4	-	-

□ TV set top box/satellite users please note

When using the optical or coaxial digital audio output on a TV/satellite box:

To play the video signal assigned to “HDMI” combined with the audio signal assigned at “Input Assign” – “DIGITAL”, you will also need to select “Digital” in the “Input Mode” (see page 157).



■ HDMI

Set this to change the HDMI input connectors assigned to the input sources.

1 / 2 / 3 / 4 / 5 / 6 / FRONT : Assign an HDMI input connector to the selected input source.

– : Do not assign an HDMI input connector to the selected input source.



- When “HDMI Control” (see page 150) is set to “On”, HDMI input connector cannot be assigned to “TV AUDIO”.

■ DIGITAL

Set this to change the digital audio input connectors assigned to the input sources.

COAX1 (Coaxial) / **COAX2** / **OPT1** (Optical) / **OPT2** :

Assign a digital input connector to the selected input source.

– : Do not assign a digital input connector to the selected input source.

■ ANALOG

Set this to change the analog audio input connectors assigned to the input sources.

1 / 2 / 3 / 4 / FRONT : Assign an analog input connector to the selected input source.

– : Do not assign an analog input connector to the selected input source.

■ COMP (Component video)

Set this to change the component video input connectors assigned to the input sources.

1 / 2 : Assign the component video input connector to the selected input source.

– : Do not assign a component video input connector to the selected input source.

■ VIDEO

Set this to change the composite video input connectors assigned to the input sources.

1 / 2 / FRONT : Assign the video input connector to the selected input source.

– : Do not assign a video input connector to the selected input source.

■ Set Defaults

The “Input Assign” settings are returned to the default settings.



Source Rename

Change the display name of the selected input source.

This is convenient when the input source name of your device and the input source name of this unit are different. You can change the name to suit your needs. When the renaming is completed, the name is displayed on this unit's display and on the menu screen.

CBL/SAT / DVD / Blu-ray / GAME / AUX1 / AUX2 / MEDIA PLAYER / CD / TV AUDIO / M-XPort : Change the display name of the selected input source.

Set Defaults : The "Source Rename" settings are returned to the default settings.



- Up to 12 characters can be input. For character input, see [page 138](#).

Hide Sources

Remove from the display input sources that are not used.

Show (Default) : Use this source.

Hide : Do not use this source.

Source Level

- This function corrects the playback level of the selected input source's audio input.
- Make this setting if there are differences in the input volume levels between the different sources.

-12dB – +12dB (Default : 0dB)



Input Select

Set the audio input mode and decode mode of each input source.
The input modes available for selection may vary depending on the input source.

Input Mode

Set the audio input modes for the different input sources.

It is normally recommended to set the audio input mode to "Auto".

Auto (Default) : Automatically detect input signal and perform playback.

HDMI : Play only signals from HDMI input.

Digital : Play only signals from digital input.

Analog : Play only signals from analog input.

7.1CH IN : Only signals input from the 7.1CH IN connector will be played back.



- When digital signals are properly input, the **DIG.** indicator lights on the display.
If the **DIG.** indicator does not light, check "Input Assign" (☞ page 154) and the connections.
- If "HDMI Control" is set to "On" and a TV compatible with the ARC is connected via the HDMI MONITOR connectors, the input mode whose input source is "TV AUDIO" is fixed to ARC.
- The sound mode cannot be set if the input mode is set to "7.1CH IN".

Decode Mode

Set the audio decode mode for input source.

Auto (Default) : Detect type of digital input signal and decode and play automatically.

PCM : Decode and play only PCM input signals.

DTS : Decode and play only DTS input signals.



- This item can be set for input sources for which "DIGITAL" is assigned at "Input Assign" (☞ page 154).
- Normally set this mode to "Auto". It is recommended to set "PCM" or "DTS" when audio is missing at the beginning or a noise occurs. Set "PCM" and "DTS" when inputting the corresponding input signal.



Speakers

The acoustic characteristics of the connected speakers and listening room are measured and the optimum settings are made automatically. This is called “Audyssey® Setup”.

You do not have to perform Audyssey® Setup when you have already performed Speaker Calibration in Setup Assistant.

To set up the speakers manually, use “Manual Setup” ( [page 167](#)) on the menu.

Audyssey® Setup

To perform measurement, place the Setup and measurement microphone in multiple locations all around the listening area. For best results, we recommend you measure in six or more positions, as shown in the illustration (up to eight positions).



- When performing Audyssey® Setup, Audyssey MultEQ® XT/Audyssey Dynamic EQ®/Audyssey Dynamic Volume® functions become active ( [page 145, 146](#)).

NOTE

- Make the room as quiet as possible. Background noise can disrupt the room measurements. Close windows and turn off the power on electronic devices (TVs, radios, air conditioners, fluorescent lights, etc.). The measurements could be affected by the sounds emitted by such devices.
- During the measurement process, place cell phones outside the listening room. Cell phone signals could disrupt the measurements.
- Do not stand between the speakers and Setup and measurement microphone or allow obstacles in the path while the measurements are being made. Do not hold the Setup and measurement microphone in your hand during measurements. This will cause inaccurate readings.
- During the measurement process, audible test tones will come from the speakers and subwoofer(s), but this is part of normal operation. If there is background noise in the room, these test signals will increase in volume.
- Operating VOLUME ▲▼ on the remote control unit or VOLUME on the main unit during the measurements will cancel the measurements.
- Measurement cannot be performed when headphones are connected. Unplug the headphones before performing Audyssey® Setup.



■ About Setup and measurement microphone placement

- Measurements are performed by placing the Setup and measurement microphone successively at multiple positions throughout the entire listening area, as shown in **[Example ①]**.
- Even if the listening environment is small as shown in **[Example ②]**, measuring at multiple points throughout the listening environment results in more effective correction.

[Example ①]

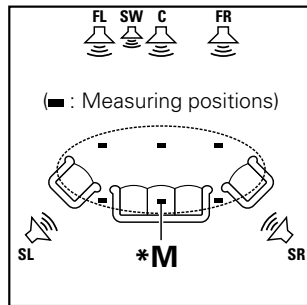

[Example ②]

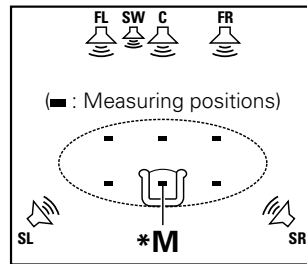

FL Front speaker (L)
FR Front speaker (R)
C Center speaker

SW Subwoofer
SL Surround speaker (L)
SR Surround speaker (R)

■ About the main listening position (*M)

The main listening position is the position where listeners would normally sit or where one would normally sit alone within the listening environment. Before starting Audyssey® Setup, place the Setup and measurement microphone in the main listening position. Audyssey MultEQ® XT uses the measurements from this position to calculate speaker distance, level, polarity, and the optimum crossover value for the subwoofer.



Procedure for speaker settings (Audyssey® Setup)

Preparation



Measurement



Calculation



Check



Store



Finish

1 Mount the Setup and measurement microphone on a tripod or stand and place it in the main listening position.

When you set the setup microphone, point the tip of it toward the ceiling, at the height of your ears in your listening position.

2 If using a subwoofer capable of the following adjustments, set up the subwoofer as shown below.

- When using a subwoofer with a direct mode
Set the direct mode to "On" and disable the volume adjustment and crossover frequency setting.
- When using a subwoofer without a direct mode
Make the following settings:
 - Volume : "12 o'clock position"
 - Crossover frequency : "Maximum/Highest Frequency"
 - Low pass filter : "Off"
 - Standby mode : "Off"



3 Connect the Setup and measurement microphone to the SETUP MIC jack of this unit.

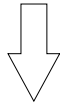
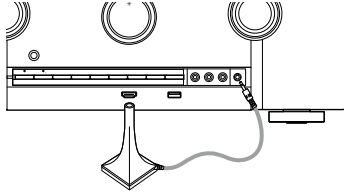

When the Setup and measurement microphone is connected, the following screen is displayed.



4 Select "Start" and then press ENTER.

Audyssey® Setup can also make the following settings.

- **Amp Assign**

The signal output from the SURROUND BACK speaker terminals of this unit can be switched to match your speaker environment. Refer to "Amp Assign" ([page 167](#)).

- **Channel Select**

If channels that are not to be used are set in advance, measurement for the set channels is skipped, and measuring time can be reduced. You can also change the number of surround back speakers.

5 Select "Next" and then press ENTER.

6 Select "Begin Test" and then press ENTER.

- Measurement requires several minutes.

NOTE

- **If "Caution!" is displayed on TV screen:**

Go to "Error messages" ([page 165](#)). Check any related items, and perform the necessary procedures.

When measuring has stopped

① Press BACK to display the popup screen.

② Press < to select "Yes", and then press ENTER.



7 The detected speakers are displayed.



8 Select "Next" and then press ENTER.

9 Move the Setup and measurement microphone to position 2, select "Continue", and then press ENTER.

The measurement of the second position starts. Measurements can be made in up to eight positions.



- To skip measuring the second and subsequent listening position, use ∇ to select "Calculation" and press ENTER to proceed to step 12.



10 Repeat step 9, measuring positions 3 to 8.

11 Select "Calculation" and then press ENTER.

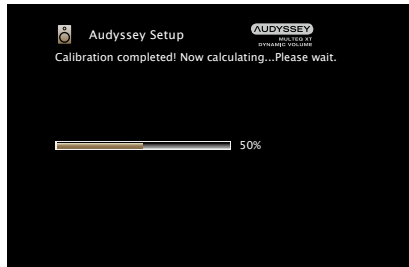

- Analysis takes several minutes to complete. The more speakers and measurement positions that there are, the more time it takes to perform the analysis.

12 Use Δ / ∇ to select the item you want to check, and then press ENTER.



- Subwoofers may measure a greater reported distance than the actual distance due to added electrical delay common in subwoofers.



13 Select "Store" and then press ENTER.

Save the measurement results.



- Saving the results requires about 20 seconds.

NOTE

- During saving of measurement results, be sure not to turn off the power.

14 Unplug the Setup and measurement microphone from the unit's SETUP MIC jack.

15 Set Audyssey Dynamic Volume®.

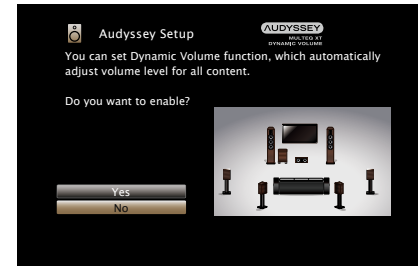

- This feature adjusts the output volume to the optimal level while constantly monitoring the level of the audio input to the unit. Optimal volume control is performed automatically without any loss in the dynamism and clarity of the sound when, for example, the volume suddenly increases for commercials shown during television programs.

NOTE

- After performing Audyssey® Setup, do not change the speaker connections or subwoofer volume. In event of a change, perform Audyssey® Setup again.



Error messages

An error message is displayed if Audyssey® Setup could not be completed due to speaker placement, the measurement environment, etc. If an error message is displayed, check the relevant items and perform the necessary measures. Be sure to turn off the power before checking speaker connections.

Examples	Error details	Measures
Microphone or Speaker is None	<ul style="list-style-type: none"> • Setup and measurement microphone is not detected. • Not all speakers could be detected. 	<ul style="list-style-type: none"> • Connect the included Setup and measurement microphone to the SETUP MIC jack of this unit. • Check the speaker connections.
Ambient noise is too high or level is too low	<ul style="list-style-type: none"> • There is too much noise in the room. • Speaker or subwoofer sound is too low. 	<ul style="list-style-type: none"> • Either turn off any device generating noise or move it away. • Perform again when the surroundings are quieter. • Check the speaker installation and the direction in which the speakers are facing. • Adjust the subwoofer's volume.
Front R : None	<ul style="list-style-type: none"> • The displayed speaker could not be detected. 	<ul style="list-style-type: none"> • Check the connections of the displayed speaker.
Front R : Phase	<ul style="list-style-type: none"> • The displayed speaker is connected with the polarity reversed. 	<ul style="list-style-type: none"> • Check the polarity of the displayed speaker. • For some speakers, this error message may be displayed even if the speaker is properly connected. If you are sure the connection is correct, use \triangleright to select "Skip Error", then press ENTER.



Retrieving Audyssey® Setup settings

If you set “Restore...” to “Restore”, you can return to Audyssey® Setup measurement result (value calculated at the start by MultEQ® XT) even when you have changed each setting manually.

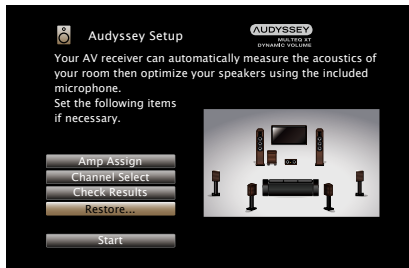

Manual Setup

Perform when setting the speakers manually or when changing settings made in Audyssey® Setup.

- If you change the speaker settings after performing Audyssey® Setup, it will not be possible to select Audyssey MultEQ® XT, Audyssey Dynamic EQ® and Audyssey Dynamic Volume® (🔍 page 145, 146).
- “Manual Setup” can be used without changing the settings. Please set if necessary.

Amp Assign

Select power amplifier usage method to match your speaker system.

■ Assign Mode

Set the assignment mode.

Surround Back (Default) : Setting for 7.1-channel playback using surround back speakers.

ZONE2 : Setting to assign the unit’s built-in power amplifier for ZONE2 and output the audio in stereo.

Bi-AMP : Setting to use the front speakers via the bi-amp connection.

Front B : Setting to use the second set of front speakers for playback. You can switch the speaker to be used as the “Front Speaker” (🔍 page 172) between Front speaker A and B.

Front Height : Setting for 7.1-channel playback using front height speakers.



Speaker Config.

Indicate speaker presence and select speaker size categories based on bass reproduction capability.

■ Front

Set the front speaker size.

Large : Use a large speaker that can adequately play back very low bass frequencies.

Small (Default) : Use a small speaker that has inadequate playback capacity for very low bass frequencies. Note that for most multi-channel speakers, this is the best choice.



- When "Subwoofer" is set to "No", "Front" is automatically set to "Large".
- When "Front" is set to "Small", "Center", "Surround", "Surr. Back" and "Front Height" can not be set to "Large".

■ Center

Set the presence and size of the center speaker.

Large : Use a large speaker that can adequately play back very low bass frequencies.

Small (Default) : Use a small speaker that has inadequate playback capacity for very low bass frequencies. Note that this is almost always the best choice.

None : Select when a center speaker is not connected.

■ Subwoofer

Set the presence of a subwoofer.

Yes (Default) : Use a subwoofer.

No : Select when a subwoofer is not connected.

■ Surround

Set the presence and size of the surround speakers.

Large : Use a large speaker that can adequately play back very low bass frequencies.

Small (Default) : Use a small speaker that has inadequate playback capacity for very low bass frequencies. Note that this is almost always the best choice.

None : Select when the surround speakers are not connected.



- When "Surround" is set to "None", "Surr. Back" and "Front Height" are automatically set to "None".



■ Surr. Back

Set the presence, size and number of surround back speakers.

Large : Use a large speaker that can adequately play back very low bass frequencies.

Small (Default) : Use a small speaker that has inadequate playback capacity for very low bass frequencies. Note that this is almost always the best choice.

None : Select when the surround back speakers are not connected.

2spkrs (Default) : Use two surround back speakers.

1spkr : Use only one surround back speaker. When you select this setting, connect the surround back speaker to the left (L) channel.



- When “Assign Mode” ([see page 167](#)) setting is “Surround Back”, you can make the “Surr. Back” setting.

■ Front Height

Set the presence and size of the front height speakers.

Large : Use a large speaker that can adequately play back very low bass frequencies.

Small (Default) : Use a small speaker that has inadequate playback capacity for very low bass frequencies. Note that this is almost always the best choice.

None : Select when the front height speakers are not connected.



- When “Assign Mode” ([see page 167](#)) setting is “Front Height”, you can make the “Front Height” setting.



Distances

Set distance from listening position to speakers.
Measure beforehand the distance from the listening position to each speaker.

■ Unit

Set the unit of distance.

Feet (Default)

Meters

■ Step

Set the minimum variable width of the distance.

1ft (Default) / **0.1ft**

0.1m / **0.01m**

■ Set Defaults

The “Distances” settings are returned to the default settings.

■ Set the distance

0.0ft – 60.0ft / 0.00m – 18.00m



- The speakers that can be selected differ depending on the “Amp Assign” ([page 167](#)) and “Speaker Config.” ([page 168](#)) settings.
- Default settings :
Front L / Front R / F. Height L / F. Height R / Center / Subwoofer : 12.0 ft (3.60 m)
Surround L / Surround R / Surr. Back L / Surr. Back R : 10.0 ft (3.00 m)
- Set the difference in the distance between the speakers to less than 20.0 ft (6.00 m).

Levels

Set the volume of the test tone to be the same when it is output from each speaker.

■ Test Tone Start

Output test tone. A test tone is output from the selected speaker. While listening to the test tone, adjust the volume output from the selected speaker.

-12.0dB – +12.0dB (Default : 0.0dB)



- When “Levels” is adjusted, the adjusted values are set for all the sound modes.
- When headphones are connected to the PHONES connector on this unit, you cannot set “Levels”.

■ Set Defaults

The “Levels” settings are returned to the default settings.



Crossovers

Set the maximum frequency of the bass signal output from each channel to the subwoofer. Set the Crossover Frequency to suit the bass reproduction capability of the speaker being used.

■ Speaker Selection

Selects how to set the crossover frequency. See the speaker manual for information concerning speaker crossover frequency.

All (Default) : Selects the crossover point of all speakers at the same time.

Individual : Selects the crossover points for each speaker individually.

■ Set the crossover frequency

40Hz / 60Hz / 80Hz (Default) / **90Hz / 100Hz / 110Hz / 120Hz / 150Hz / 200Hz / 250Hz**



- “Crossovers” can be set when the “Subwoofer Mode” ([page 172](#)) setting is “LFE+Main”, or when you have a speaker that is set to “Small”.
- The default crossover frequency is “80Hz”, which will work best with the widest variety of speakers. When using very small speakers, however, you can choose a higher setting based on the specified frequency response of the speakers. If the speaker has a specified frequency response of 120 Hz – 20 kHz (as an example), then choose the 120 Hz crossover frequency.
- For speakers set to “Small”, low frequency content below the crossover frequency is attenuated to the speakers and the low bass content is then re-delivered to the subwoofer, or the front (L/R) speakers if they have been set to Large.
- The speakers that can be set when “Individual” is selected differ depending on to the “Subwoofer Mode” ([page 172](#)) setting.
 - When “LFE” is selected, speakers set to “Small” at “Speaker Config.” ([page 168](#)) can be set. If the speakers are set to “Large”, “Full Band” is displayed and the setting cannot be made.
 - When “LFE+Main” is selected, speakers can be set regardless of the “Speaker Config.” ([page 168](#)) setting.



Bass

Set subwoofer and LFE signal range playback.

■ Subwoofer Mode

Select low range signals to be reproduced by subwoofer.

LFE (Default) : The low range signal of the channel set to "Small" speaker size is added to the LFE signal output from the subwoofer.

LFE+Main : The low range signal of all channels is added to the LFE signal output from the subwoofer. This is usually the best setting for most systems.



- "Subwoofer Mode" can be set when "Speaker Config." – "Subwoofer" ([page 168](#)) is set to other than "No".
- Play music or a movie source and select the mode offering the strongest bass.
- If "Front" and "Center" for "Speaker Config." ([page 168](#)) are set to "Large", and "Subwoofer Mode" is set to "LFE", no sound may be output from the subwoofers, depending on the input signal or selected sound mode. Select "LFE+Main" if you want the bass signals to always be produced from the subwoofer.

■ LPF for LFE

Set LFE signal playback range. Set this when you want to change the playback frequency (low pass filter point) of the subwoofer.

80Hz / 90Hz / 100Hz / 110Hz / 120Hz (Default) / **150Hz / 200Hz / 250Hz**

Front Speaker

Set the front speakers to use.



- This can be set when "Assign Mode" ([page 167](#)) is set to "Front B".

A (Default) : Front speaker A is used.

B : Front speaker B is used.

A+B : Both front speakers A and B are used.



Network

To use this unit by connecting it to a home network (LAN), you must configure network settings.

If you set up your home network (LAN) via DHCP, set “DHCP” to “On” (use the default setting). This allows this unit to use your home network (LAN).

If you assign an IP address for each device, you must use the “IP Address” setting to assign an IP address to this unit and enter the information about your home network (LAN) such as the gateway address and subnet mask.

Information

Display network information.

Friendly Name / DHCP On or Off / IP Address / MAC Address



- MAC Address is required to make a vTuner account.

IP Control

Enables network communication in standby power mode.

Off In Standby : Suspend network function during standby.

Always On (Default) : Network is on during standby. Main unit operable with a network compatible controller.



- Set to “Always On” when using the web control function.

NOTE

- When “IP Control” is set to “Always On”, it consumes more standby power.

Friendly Name

The Friendly Name is the name of this unit displayed on the network. You can change the Friendly Name according to your preferences.

■ Edit Name

Edits Friendly Name.



- The default Friendly Name on first use is “Marantz SR5008”.
- Up to 63 characters can be input.
- For character input, see [page 138](#).

■ Set Defaults

Restores Friendly Name, which you had changed, to the default setting.



Settings

Make settings for wired LAN.

- If you are using a broadband router (DHCP function), there is no need to make the settings at “IP Address” and “Proxy”, since the DHCP function is set to “On” in this unit’s default settings.
- Only set “Settings” when connecting to a network without a DHCP function.

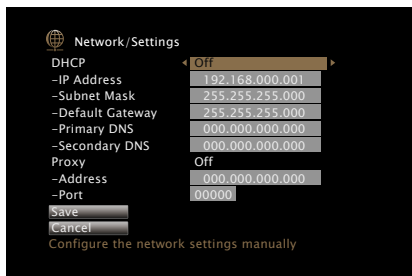

■ DHCP

Selects how to connect to the network.

On (Default) : Configure the network settings automatically from your router.

Off : Configure the network settings manually.

■ IP Address

Set the IP address within the ranges shown below.

- The Network Audio function cannot be used if other IP addresses are set.

CLASS A: 10.0.0.1 – 10.255.255.254

CLASS B: 172.16.0.1 – 172.31.255.254

CLASS C: 192.168.0.1 – 192.168.255.254

■ Subnet Mask

When connecting an xDSL modem or connector adapter directly to this unit, input the subnet mask indicated in the documentation supplied by your provider. Normally input 255.255.255.0.

■ Default Gateway

When connected to a gateway (router), input its IP address.

■ Primary DNS, Secondary DNS

If there is only one DNS address indicated in the documentation supplied by your provider, input it at “Primary DNS”. If two or more DNS are provided by your provider, enter both “Primary DNS” and “Secondary DNS”.



■ Proxy

Make this setting when connecting to the Internet via a proxy server. Make the proxy settings only when you connect to the Internet via a proxy server that is on your internal network or provided by your provider, etc.

On(Address) : Select when inputting by address.

On(Name) : Select when inputting by domain name. Up to 38 characters can be input.

Off (Default) : Disables the proxy server.

■ Port

Enter port number.



- If you cannot connect to the Internet, recheck the connections and settings ( page 45).
- If you do not understand about Internet connection, contact your ISP (Internet Service Provider) or the store from which you purchased your computer.

Diagnostics

Used to check the network connection.

■ Physical Connection

Checks the physical LAN port connection.

OK

Error : The LAN cable is not connected. Check the connection.

■ Router Access

Checks the connection from this unit to the router.

OK

Error : Failed to communicate with the router. Check the router settings.

■ Internet Access

Checks whether this unit has access to the Internet (WAN).

OK

Error : Failed to connect to the Internet. Check the Internet connection environment or router settings.



Maintenance Mode

Use when receiving maintenance from a Marantz service engineer or custom installer. Ordinarily, this mode isn't suitable for use by the end user, only by a trained service technician or custom installation professional.

NOTE

- Only use this function if so instructed by a Marantz serviceperson or installer.



General

Make various other settings.

Language

Set the language for display on the menu screen.

English (Default) / **Français** / **Español**



- “Language” can also be set by the following procedure. However, the menu screen is not displayed.

Following the display content to make the setting.

1. Press and hold the main unit’s ZONE2 SOURCE and STATUS for at least 3 seconds.
“Video Format <NTSC>” appears on the display.
2. Press the main unit’s DISPLAY.
“GUI Language ENGLISH” appears on the display.
3. Use the main unit’s PRESET CH +, – and set the language.
4. Press the main unit’s STATUS to complete the setting.

ZONE2 Setup

Set the audio to play back with multi-zone (ZONE2).



- The setting values (dB) for “Volume Limit” and “Power On Volume” are what is displayed when “Scale” (🔍 page 144) in the menu is set to “–79.5dB – 18.0dB”.

■ Lch Level

Adjust the left channel output level.

–12dB – +12dB (Default : 0dB)

■ Rch Level

Adjust the right channel output level.

–12dB – +12dB (Default : 0dB)

■ Volume Level

Set the volume output level.

Variable (Default) : Volume adjustment is enabled by main unit and remote control unit.

1 – 98 (–79dB – 18dB) : The volume is adjusted to the set level.



■ Volume Limit

Make a setting for maximum volume.

60 (-20dB) / 70 (-10dB) / 80 (0dB) (Default : 70 (-10dB))

Off : Do not set a maximum volume.

■ Power On Volume

Define the volume setting that is active when the power is turned on.

Last (Default) : Use the memorized setting from the last session.

Mute : Always mute when power is turned on.

1 - 98 (-79dB - 18dB) : The volume is adjusted to the set level.

■ Mute Level

Set the amount of attenuation when muting is on.

Full (Default) : The sound is muted entirely.

-40dB : The sound is attenuated by 40 dB down.

-20dB : The sound is attenuated by 20 dB down.



- This can be set when “Volume Level” ( page 177) is set to “Variable”.

Zone Rename

Change the display title of each zone to one you prefer.

MAIN ZONE / ZONE2

Set Defaults : The input source name is returned to the default setting.



- Up to 10 characters can be input.
- For character input, see [page 138](#).

Trigger Out

Selects when to activate trigger out.

For details about how to connect the DC OUT jacks, see “DC OUT jack” ( page 49).

- When setting for zone (MAIN ZONE / ZONE2)
Trigger out is activated through linkage to the power of the zone set to “On”.
- When setting for input source
Activate trigger out when the input source set to “On” is selected.

On : Activate trigger on this mode.

--- : Do not activate trigger on this mode.



Auto Standby

When you do not perform any operation on this unit with no audio or video input for a specified time, this unit automatically enters the standby mode. Before it enters the standby mode, "Auto Standby" is displayed on the display of this unit and the menu screen.

60 min : The unit goes into standby after 60 minutes.

30 min : The unit goes into standby after 30 minutes.

Off (Default) : The unit does not go into standby automatically.

Front Display

Makes settings related to the display on this unit.

■ Display

Select the front display mode.

On (Default) : Display is always on.

Auto Off : Display is off except when showing the status display.

Off : Display is always off.



- This can also be set by pressing DISPLAY on the main unit.

Information

Show information about receiver settings, input signals, etc.

■ Audio

Show the audio information for MAIN ZONE.

Sound Mode : The currently set sound mode.

Input Signal : The input signal type.

Format : The number of input signal channels (presence of front, surround, LFE).

Sample Rate : The input signal's sampling frequency.

Offset : The dialogue normalization correction value.

Flag : This is displayed when inputting signals including a surround back channel. "MATRIX" is displayed with Dolby Digital EX and DTS-ES Matrix signals, "DISCRETE" with DTS-ES Discrete signals.

Dialogue normalization function

This function is automatically activated when playing Dolby Digital, Dolby Digital Plus, Dolby TrueHD, DTS and DTS-HD sources. It automatically corrects the standard signal level for individual program sources.

The correction value can be checked using the STATUS on the main unit.

Offset
- 4dB

The figure is the corrected value. This cannot be changed.



Video

Show the HDMI input/output signals and HDMI monitor information for MAIN ZONE.

HDMI Signal Info.

Resolution / Color Space / Pixel Depth

HDMI Monitor

Interface / Resolutions

ZONE

Show information about current settings.

MAIN ZONE : This item shows information about settings for MAIN ZONE. The information displayed differs according to the input source.

ZONE2 : This item shows information about settings for ZONE2.

Firmware

Version : Displays information for the current firmware.

Notifications

Selects notification message preferences.

Notification Alerts

On (Default) : Displays notification messages from Marantz in the popup menu.

Off : Does not display notification messages from Marantz in the popup menu.



- Press INFO to display current source name, volume, sound mode name, and other information at the bottom of the screen.

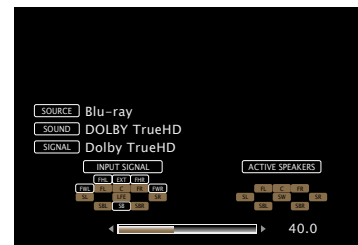

NOTE

- The status display screen cannot be displayed at a computer's resolution (e.g. VGA) is being played.



Usage Data

To help us improve our products and customer service, Marantz collects anonymous information about how you use your AV receiver (such as frequently used input sources and sound modes and speaker settings). Marantz will never provide any information we collect to third parties.

Yes : Provide Marantz with information about how you use this unit via the network.

No : Do not provide Marantz with information about how you use this unit via the network.

Firmware

Set whether or not to check for firmware update, update the firmware, and display update and upgrade notifications.

■ Update

Update the firmware of the receiver.

Check for Update : Check for firmware updates. You can also check approximately how long it will take to complete an update.

Update Start : Execute the update process. When the update starts, the menu screen is shut down. During the update, the progress is shown on the display.



- If updating fails, the set automatically retries, but if updating is still not possible, one of the messages shown below is displayed. If the display reads as shown below, check the settings and network environment, then update again.

Display	Description
Updating fail	Updating failed.
Login failed	Failure to log into server.
Server is busy	Server is busy. Wait a while then try again.
Connection fail	Failure in connecting to server.
Download fail	Downloading of the firmware has failed.



■ Notifications

When the latest firmware is available, a notification message is displayed on the TV screen at power on.

The notification message is displayed for about 20 seconds when the power is turned on. Connect to broadband Internet ( page 45) when using this function.

Update

On (Default) : Display update message.

Off : Do not display update message.

Upgrade

On (Default) : Display upgrade message.

Off : Do not display upgrade message.

■ Add New Feature

Display new features that can be downloaded to this unit and perform an upgrade.

Upgrade Package : Display the items to be upgraded.

Upgrade Status : Display a list of the additional functions provided by the upgrade.



Upgrade Start : Execute the upgrade process. When the upgrade starts, the menu screen is shut down. During the upgrade, the amount of upgrade time which has elapsed is displayed.



- See the Marantz website for details about upgrades.
- When the procedure is complete, "Registered" is displayed in this menu and upgrades can be carried out. If the procedure has not been carried out, "Not Registered" is displayed.
The ID number shown on this screen is needed when carrying out the procedure.
The ID number can also be displayed by pressing and holding the main unit's SOUND MODE and STATUS for at least 3 seconds.
- If the upgrade is not successful, an error message identical to those in "Update" will appear on the display. Check the settings and network environment and then perform the upgrade again.



Notes concerning use of "Update" and "Add New Feature"

- In order to use these functions, you must have the correct system requirements and settings for a broadband Internet connection ( page 45).
- Do not turn off the power until updating or upgrading is completed.
- Even with a broadband connection to the Internet, approximately 1 hour is required for the updating/upgrading procedure to be completed.
- Once updating/upgrade starts, normal operations on this unit cannot be performed until updating/upgrading is completed. Furthermore, there may be cases where backup data is reset for the parameters, etc., set on this unit.
- If the update or upgrade fails, press and hold the  on the main unit for more than 5 seconds, or remove and re-insert the power cord. "Update retry" appears on the display and update restarts from the point at which update failed. If the error continues despite this, check the network environment.



- Information regarding the "Update" function and "Add New Feature" will be announced on the Marantz web site each time related plans are defined.

Setup Lock

Protect settings from inadvertent changes.

■ Lock

On : Turn protection on.

Off (Default) : Turn protection off.



- When cancelling the setting, set "Lock" to "Off".

NOTE

- When "Lock" is set to "On", no setting items are displayed except for "Setup Lock".



Specifying the zone used with the remote control unit

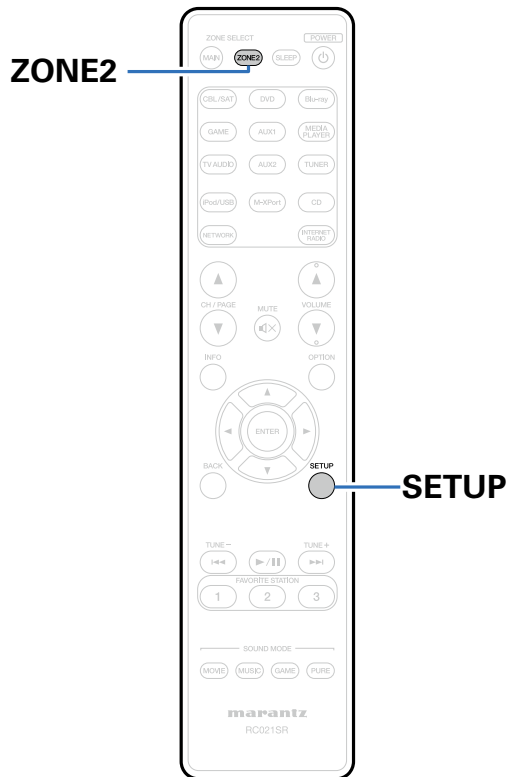

When the ZONE2 button is pressed, only the MAIN ZONE can be operated with the remote control unit.

This is useful for preventing mistaken operation.

- 1 Press and hold ZONE2 and SETUP.**
MAIN and ZONE2 button blink.

■ To cancel

- 1 Press and hold ZONE2 and SETUP.**
MAIN and ZONE2 button blink.



Tips

Contents

■ Tips	(186)	■ Troubleshooting	(188)
I want the volume not to become too loud by mistake.....	(186)	Power does not turn on/Power is turned off	(188)
I want to keep the volume at the same level when I turn the power on	(186)	Operations cannot be performed through the remote control unit.....	(189)
I want to have the subwoofer always output audio	(186)	Display on this unit shows nothing	(189)
I want to make human voices in the movies clearer	(186)	No sound comes out	(190)
I want to keep bass and clarity during playback at a lower volume level	(186)	Desired sound does not come out	(191)
I want to automatically adjust the volume level difference in content such as TV and movies	(186)	Sound is interrupted or noise occurs.....	(193)
I want to set the optimized listening environment after changing the configuration/position of the speakers or changing a speaker to a new one	(186)	No video is shown on the TV	(193)
I want to combine a desired video with the current music	(187)	The menu screen is not displayed on the TV	(194)
I want to play back photos from Flickr at the same time while listening to the Internet radio	(187)	iPod cannot be played back.....	(195)
I want to delete unused input sources	(187)	USB memory devices cannot be played back	(196)
I want to enjoy the same music in all zones at the home party, etc.	(187)	File names on the iPod/USB memory device are not displayed properly	(197)
I want to minimize the delay in video signals when I'm playing a game on my game console	(187)	The Internet radio cannot be played back	(197)
How to add Wi-Fi to the AV receiver?	(187)	Music files on PC or NAS cannot be played back.....	(198)
		The HDMI control function does not work.....	(199)
		When using ZONE2, no sound comes out.....	(199)



Tips

I want the volume not to become too loud by mistake.

- Set the volume upper limit for “Volume Limit” in the menu beforehand. This prevents children or others from increasing the volume too much by mistake. You can set this for each zone ( [page 144, 178](#)).

I want to keep the volume at the same level when I turn the power on.

- By default, the volume setting when power was previously set to standby is applied at next power on. To use a fixed volume level, set the volume level at power on for “Volume Limit” in the menu. You can set this for each zone ( [page 144, 178](#)).

I want to have the subwoofer always output audio.

- Depending on the input signals and sound mode, the subwoofer may not output audio. When “Subwoofer Mode” in the menu is set to “LFE+Main”, you can have the subwoofer always output audio ( [page 172](#)).

I want to make human voices in the movies clearer.

- Use “Dialog Level” in the menu to adjust the level ( [page 139](#)).

I want to keep bass and clarity during playback at a lower volume level.

- Set “Dynamic EQ” in the menu to “On”. This setting corrects the frequency characteristics to allow you to enjoy clear sound without the bass being lost even during playback at a lower volume level ( [page 145](#)).

I want to automatically adjust the volume level difference in content such as TV and movies.

- Set “Dynamic Volume” in the menu. Volume level changes (between quiet scenes and loud scenes) in TV shows or movies are automatically adjusted to your desired level ( [page 146](#)).

I want to set the optimized listening environment after changing the configuration/position of the speakers or changing a speaker to a new one.

- Perform Audyssey® Setup. This automatically makes the optimized speaker settings for the new listening environment ( [page 158](#)).



I want to combine a desired video with the current music.

- Set “Video Select” in the option menu to “On”. You can combine the current music with your desired video source from Set-top Box or DVD, etc. while listening to music from Tuner, CD, M-XPort or the Internet radio ( [page 104](#)).

I want to play back photos from Flickr at the same time while listening to the Internet radio.

- After playing back photos from Flickr, start the slide show on the Internet radio playback screen ( [page 103](#)).

I want to delete unused input sources.

- Set unused input sources for “Hide Sources” in the menu. This allows you to skip unused input sources when rotating the INPUT SELECTOR knob on this unit ( [page 156](#)).

I want to enjoy the same music in all zones at the home party, etc.

- Set “All Zone Stereo” in the option menu to “On”. This allows you to simultaneously play back in ZONE2 the music that is played back in MAIN ZONE ( [page 106](#)).

I want to minimize the delay in video signals when I’m playing a game on my game console.

- When the video is delayed against button operations with the controller on the game console, set “Video Mode” in the menu to “Game” ( [page 151](#)).

How to add Wi-Fi to the AV receiver?

- Connect a wireless LAN converter (sold separately) to the NETWORK connector on this unit.



Troubleshooting

If a problem should arise, first check the following:

1. Are the connections correct?
2. Is the set being operated as described in the owner's manual?
3. Are the other devices operating properly?

If this unit does not operate properly, check the items listed in the table below. Should the problem persist, there may be a malfunction. In this case, disconnect the power immediately and contact your store of purchase.

■ Power does not turn on / Power is turned off

Symptom	Cause / Solution	Page
Power does not turn on.	<ul style="list-style-type: none"> • Check whether the power plug is correctly inserted into the power outlet. 	<u>50</u>
Power automatically turns off.	<ul style="list-style-type: none"> • The sleep timer is set. Turn on the power again. • "Auto Standby" is set. "Auto Standby" is triggered when there is no operation for a set amount of time. To disable "Auto Standby", set "Auto Standby" on the menu to "Off". 	<u>120</u> <u>179</u>
Power turns off and the power indicator flashes in red approx. every 2 seconds.	<ul style="list-style-type: none"> • Due to the temperature rise within this unit, the protection circuit is working. Turn off the power and wait about an hour until this unit sufficiently cools down. Then, turn on the power again. • Please re-install this unit in a place having good ventilation. 	<u>221</u> -
Power turns off and the power indicator flashes in red approx. every 0.5 seconds.	<ul style="list-style-type: none"> • Check the speaker connection. The protection circuit may have been activated because speaker cable core wires came in contact with each other or a core wire was disconnected from the connector and came in contact with the rear panel of this unit. After unplugging the power cord, take corrective action such as firmly re-twisting the core wire or taking care of the connector, and then reconnect the wire. • Turn down the volume and turn on the power again. • This unit's amplifier circuit has failed. Turn off the power and please contact the Marantz service adviser. 	<u>25</u> <u>52, 53</u> -



■ Operations cannot be performed through the remote control unit

Symptom	Cause / Solution	Page
Operations cannot be performed through the remote control unit.	• Batteries are worn out. Replace with new batteries.	8
	• Operate the remote control unit within a distance of about 23 ft/7 m from this unit and at an angle of within 30°.	8
	• Remove any obstacle between this unit and the remote control unit.	–
	• Insert the batteries in the proper direction, checking the ⊕ and ⊖ marks.	8
	• The set's remote control sensor is exposed to strong light (direct sunlight, inverter type fluorescent bulb light, etc.). Move the set to a place in which the remote control sensor will not be exposed to strong light.	–
	• The operation target zone does not correspond to the zone setting specified on the remote control unit. Press MAIN or ZONE2 to select the zone to operate.	129 , 137
	• When using a 3D video device, the remote control unit of this unit may not function due to effects of infrared communications between units (such as TV and glasses for 3D viewing). In this case, adjust the direction of units with the 3D communications function and their distance to ensure they do not affect operations from the remote control unit of this unit.	–

■ Display on this unit shows nothing

Symptom	Cause / Solution	Page
Display is off.	• Set "Display" on the menu to something other than "Off".	179
	• When the sound mode is set to PURE DIRECT, the display is off.	109



■ No sound comes out

Symptom	Cause / Solution	Page
No sound comes out of speakers.	<ul style="list-style-type: none"> • Check the connections for all devices. • Insert connection cables all the way in. • Check that input connectors and output connectors are not reversely connected. • Check cables for damage. • Check that speaker cables are properly connected. Check that cable core wires come in contact with the metal part on speaker terminals. Also, securely tighten speaker terminals. Check speaker terminals for looseness. • Check that a proper input source is selected. • Adjust the master volume. • Cancel the mute mode. • Check the digital input connector setting. • Check the digital audio output setting on the connected device. On some devices, the digital audio output is set to off by default. • No sound is output from the speakers when headphones are connected. 	25 , 33 , 34 , 35 , 37 , 38 , 39 , 40 , 41 , 43 , 45 , 47 , 48 , 49 – – – 25 52 , 129 53 , 129 53 , 130 34 , 35 , 37 , 38 – 12
No sound comes out when using the DVI-D connection.	<ul style="list-style-type: none"> • When this unit is connected to a device equipped with a DVI-D connector, no sound is output. Make a separate audio connection. 	–
No sound comes out of a TV that is connected via HDMI.	<ul style="list-style-type: none"> • Audio signals input to 7.1CH IN connectors on this unit cannot be output to the TV. 	–



■ Desired sound does not come out

Symptom	Cause / Solution	Page
The volume does not increase.	<ul style="list-style-type: none"> • The maximum volume is set too low. Set the maximum volume using "Limit" on the menu. • Appropriate volume correction processing is performed according to the input audio format and settings, so the volume may not reach the upper limit. 	144 , 178 –
No sound comes out with the HDMI connection.	<ul style="list-style-type: none"> • Check the connection of the HDMI connectors. • When outputting HDMI audio from the speakers, set "HDMI Audio Out" on the menu to "AVR". To output from the TV, set "TV". • When using the HDMI control function, check that the audio output is set to the AV amplifier on the TV. 	33 , 34 , 37 , 38 , 39 149 119
No sound comes out of a specific speaker.	<ul style="list-style-type: none"> • Check that the speaker cable is properly connected. • Check that a selection other than "None" is set for the "Speaker Config." setting in menu. • Check the "Assign Mode" setting in the menu. • When the sound mode is "STEREO" and "VIRTUAL", audio is only output from the front speakers and subwoofer. 	25 168 , 169 167 –
No sound is produced from subwoofer.	<ul style="list-style-type: none"> • Check the subwoofer connections. • Turn on the subwoofer's power. • Set "Speaker Config." – "Subwoofer" on the menu to "Yes". • When "Speaker Config." – "Front" in the menu is set to "Large", depending on the input signal and the sound mode, no sound may be output from the subwoofer. • When no subwoofer audio signal (LFE) is included in the input signals, no sound may be output from the subwoofer. • You can make the subwoofer always output sound by setting the subwoofer mode to "LFE+Main". 	26 – 168 168 172 172



Symptom	Cause / Solution	Page
DTS sound is not output.	<ul style="list-style-type: none"> • Check that the digital audio output setting on the connected device is set to "DTS". • Set "Decode Mode" on the menu to "Auto" or "DTS". 	– <u>157</u>
Dolby TrueHD, DTS-HD, Dolby Digital Plus audio is not output.	<ul style="list-style-type: none"> • Make HDMI connections. • Check the digital audio output setting on the connected device. On some devices, "PCM" is set by default. 	<u>37, 38, 39</u> –
Dolby PLII mode or DTS NEO:6 mode cannot be selected.	<ul style="list-style-type: none"> • It cannot be selected when "None" is set for "Speaker Config." – "Center" and "Surround". • These cannot be selected when using the headphones. 	<u>168</u> –
Audyssey MultEQ® XT, Audyssey Dynamic EQ® and Audyssey Dynamic Volume® cannot be selected.	<ul style="list-style-type: none"> • These cannot be selected when you have not performed Audyssey® Setup. • Switch the sound mode to other than "DIRECT" or "PURE DIRECT". • These cannot be selected when using the headphones. • These cannot be selected when an HD audio format with a sampling frequency of over 96 kHz is input (such as may be found on select Dolby TrueHD and DTS-HD discs). 	<u>158</u> <u>109</u> – –
"M-DAX" cannot be selected.	<ul style="list-style-type: none"> • Check that an analog signal or PCM signal (Sample Rate=44.1/48 kHz) is input. For playback of multichannel signals such as Dolby Digital or DTS surround, "M-DAX" cannot be used. • Switch the sound mode to other than "DIRECT" or "PURE DIRECT". 	<u>143</u> <u>109</u>



■ Sound is interrupted or noise occurs

Symptom	Cause / Solution	Page
During playback from the Internet radio or USB memory device, sound is occasionally interrupted.	<ul style="list-style-type: none"> When the transfer speed of the USB memory device is slow, sound may occasionally be interrupted. The network communication speed is slow or the radio station is busy. 	–
When making a call on iPhone, noise occurs in audio output on this unit.	<ul style="list-style-type: none"> When making a call, keep a distance of 20 cm or longer between iPhone and this unit. 	–
Noise often occurs in FM/AM broadcasting.	<ul style="list-style-type: none"> Change the antenna orientation or position. Separate the AM loop antenna from the unit. Use an FM outdoor antenna. Separate the antenna from other connection cables. 	43 43 43 43

■ No video is shown on the TV

Symptom	Cause / Solution	Page
No picture appears.	<ul style="list-style-type: none"> Check the connections for all devices. Insert connection cables all the way in. Check that input connectors and output connectors are not reversely connected. Check cables for damage. Match the input settings to the input connector of the TV connected to this unit. Check that the proper input source is selected. Check the video input connector setting. Check that the resolution of the player corresponds to that of the TV. Check whether the TV is compatible with copyright protection (HDCP). If connected to a device not compatible with HDCP, video will not be output correctly. The HDMI signal cannot be converted to an analog signal. Use analog connections. 	33 , 34 , 35 , 37 , 38 , 39 , 40 , 41 , 43 , 45 , 47 , 48 , 49 – – – 154 52 , 129 154 180 203 204





Symptom	Cause / Solution	Page
No video is shown on the TV with the DVI-D connection.	<ul style="list-style-type: none"> With the DVI-D connection, on some device combinations, devices may not function properly due to the copy guard copyright protection (HDCP). 	203
No video from an input source such as a game console is shown on the TV.	<ul style="list-style-type: none"> When special video signals are input from a game console, etc., the video conversion function may not function. Connect the input connector to the monitor output connector of the same type. 	–
While the menu is being displayed, no video is shown on the TV.	<ul style="list-style-type: none"> When the menu is operated during playback of some 3D video contents or of video at some computer resolutions (such as VGA), no playback video is shown in the background of the menu. 	–

■ The menu screen is not displayed on the TV

Symptom	Cause / Solution	Page
The menu screen or status information screen is not displayed on the TV.	<ul style="list-style-type: none"> The menu screen is only displayed on this unit and a TV connected by HDMI cable. If this unit is connected to a TV using a different video output connector, operate while watching the display on this unit. 	–
	<ul style="list-style-type: none"> No status information is displayed for some 3D videos or videos with a computer resolution such as VGA. 	180
	<ul style="list-style-type: none"> When a 2D video is converted to a 3D video on the TV, the menu screen or status information is not properly displayed. 	–
	<ul style="list-style-type: none"> In the pure direct playback mode, the menu screen or status information is not displayed. Switch to a sound mode other than the pure direct mode. 	108 , 109
	<ul style="list-style-type: none"> Set the “TV Format” setting in the menu to a selection that is appropriate for the TV. 	153



■ iPod cannot be played back

Symptom	Cause / Solution	Page
iPod cannot be connected.	<ul style="list-style-type: none"> When using iPod by connecting it to the USB port, some iPod variations are not supported. When iPod is connected by using a USB cable other than the genuine cable, iPod may not be recognized. Use a genuine USB cable. 	42 –
The AirPlay icon  is not displayed on iTunes / iPhone / iPod touch / iPad.	<ul style="list-style-type: none"> This unit and PC / iPhone / iPod touch / iPad are not connected to the same network (LAN). Connect it to the same LAN as this unit. The firmware on iTunes / iPhone / iPod touch / iPad is not compatible with AirPlay. Update the firmware to the latest version. 	45 –
Audio is not output.	<ul style="list-style-type: none"> The volume on iTunes / iPhone / iPod touch / iPad is set to the minimum level. The volume on iTunes / iPhone / iPod touch / iPad is linked with the volume on this unit. Set a proper volume level. The AirPlay playback is not performed, or this unit is not selected. Click the AirPlay icon  on the iTunes / iPhone / iPod touch / iPad screen and select this unit. 	– 96
Audio is interrupted during the AirPlay playback on iPhone / iPod touch / iPad.	<ul style="list-style-type: none"> Quit the application running in the background of the iPhone/iPod touch/iPad, and then play using AirPlay. Some external factors may be affecting the wireless connection. Modify the network environment by taking measures such as shortening the distance from the wireless LAN access point. 	– –
iTunes cannot be played back through the remote control unit.	<ul style="list-style-type: none"> Enable the “Allow iTunes control from remote speakers” setting on iTunes. Then, you can perform playback, pause, and skip operations through the remote control unit. 	–



■ USB memory devices cannot be played back

Symptom	Cause / Solution	Page
"No Connection" is displayed.	<ul style="list-style-type: none"> • The set cannot recognize a USB memory device. Disconnect and reconnect the USB memory device. • USB memory devices of a mass storage class or those compatible with MTP are supported. • This unit does not support a connection through a USB hub. Connect the USB memory device directly to the USB port. • The USB memory device must be formatted to FAT16 or FAT32. • Not all USB memory devices are guaranteed to work. Some USB memory devices are not recognized. When using a type of portable hard disc drive compatible with the USB connection that requires power from an AC adapter, use the AC adapter that came with the drive. 	<p>41</p> <p>–</p> <p>–</p> <p>–</p> <p>–</p>
Files on the USB memory device are not displayed.	<ul style="list-style-type: none"> • Files of a type not supported by this unit are not displayed. • This unit can display a file structure with up to 8 levels and up to 5000 subfolders and files in total. Modify the folder structure of the USB memory device. • When multiple partitions exist on the USB memory device, only files on the first partition are displayed. 	<p>58</p> <p>–</p> <p>–</p>
Files on a USB memory device cannot be played.	<ul style="list-style-type: none"> • Files are created in a format that is not supported by this unit. Check the formats supported by this unit. • You are attempting to play a file that is copyright protected. Files that are copyright protected cannot be played on this unit. 	<p>206</p> <p>–</p>



■ File names on the iPod/USB memory device are not displayed properly

Symptom	Cause / Solution	Page
The file names are not displayed properly ("...", etc.).	<ul style="list-style-type: none"> Characters that cannot be displayed are used. This is not a malfunction. On this unit, characters that cannot be displayed are replaced with a "." (period). 	–

■ The Internet radio cannot be played back

Symptom	Cause / Solution	Page
A list of broadcasting stations is not displayed.	<ul style="list-style-type: none"> The LAN cable is not properly connected, or the network is disconnected. Check the connection status. Perform the network diagnostic mode. 	45 –
Internet Radio cannot be played.	<ul style="list-style-type: none"> The selected radio station is broadcasting in a format that is not supported by this unit. Formats that can be played back in this unit are MP3, WMA and AAC. The firewall function is enabled on the router. Check the firewall setting. The IP address is not properly set. Check the power of the router is on. To obtain the IP address automatically, enable the DHCP server function on the router. Also, set the DHCP setting to "On" on this unit. To obtain the IP address manually, set the IP address and proxy on this unit. Some radio stations broadcast silently during some time period. In this case, no audio is output. Wait for a while and select the same radio station, or select another radio station. 	208 – 174 – 174 174 , 175 69
Cannot connect to favorite radio stations.	<ul style="list-style-type: none"> Radio station is not currently in service. Register radio stations in service. 	–
For some radio stations, "Connection down" is displayed and station cannot be connected to.	<ul style="list-style-type: none"> The selected radio station is not in service. Select a radio station in service. 	–



■ Music files on PC or NAS cannot be played back

Symptom	Cause / Solution	Page
Files stored on a computer cannot be played.	<ul style="list-style-type: none"> Files are stored in a non-compatible format. Record in a compatible format. You are attempting to play a file that is copyright protected. Files that are copyright protected cannot be played on this unit. Set and computer are connected by USB cable. The set's USB port cannot be used for connection to a computer. Media sharing settings are not correct. Change media sharing settings so that the unit can access the folders on your computer. 	<p>207</p> <p>–</p> <p>–</p> <p>73</p>
Server is not found, or it is not possible to connect to the server.	<ul style="list-style-type: none"> The computer's or router's firewall is activated. Check the computer's or router's firewall settings. Computer's power is not turned on. Turn on the power. Server is not running. Launch the server. Set's IP address is wrong. Check the set's IP address. 	<p>–</p> <p>–</p> <p>–</p> <p>173</p>
Music files on PC cannot be played back.	<ul style="list-style-type: none"> Even if PC is connected to the USB connector on this unit, music files on it cannot be played back. Connect PC or NAS to this unit through the network. 	45
Files on PC or NAS are not displayed.	<ul style="list-style-type: none"> Files of a type not supported by this unit are not displayed. 	207
Music stored on a NAS cannot be played.	<ul style="list-style-type: none"> If you use a NAS in conformity with the DLNA standard, enable the DLNA server function in the NAS setting. If you use a NAS that does not conform with the DLNA standard, play the music via a PC. Set Windows Media Player's media sharing function and add NAS to the selected play folder. If connection is restricted, set audio equipment as the connection target. 	<p>–</p> <p>73</p> <p>–</p>



■ The HDMI control function does not work

Symptom	Cause / Solution	Page
The HDMI control function does not work.	<ul style="list-style-type: none"> • Check that "HDMI Control" in the menu is set to "On". • You cannot operate devices that are not compatible with the HDMI control function. In addition, depending on the connected device or the settings, the HDMI control function may not work. In this case, operate the external device directly. • Check that the HDMI control function setting is enabled on all devices connected to this unit. • When you make connection related changes such as connecting an additional HDMI device, the link operation settings may be initialized. Turn off this unit and devices connected via HDMI, and turn them on again. 	150 119 119 119

■ When using ZONE2, no sound comes out

Symptom	Cause / Solution	Page
When using ZONE2, no sound comes out.	<ul style="list-style-type: none"> • In ZONE2, you can select iPod/USB, TUNER, NETWORK, M-XPort or an input source with an analog audio input connector. 	129



Resetting factory settings

Perform this procedure if the display is abnormal or if operations cannot be performed.

Note that when you perform this operation, various settings are reset to their default values and setup will need to be performed again.

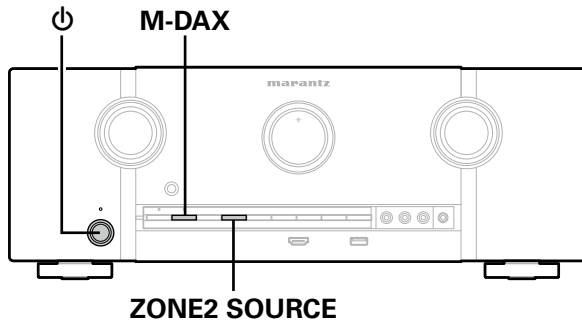

- 1 Turn off the power using ⏻.**
- 2 Press ⏻ while simultaneously pressing M-DAX and ZONE2 SOURCE.**
- 3 Once the display starts flashing at intervals of about 1 second, release the two buttons.**



- If in step 3 the display does not flash at intervals of about 1 second, start over from step 1.



Appendix

About HDMI

HDMI is an abbreviation of High-Definition Multimedia Interface, which is an AV digital interface that can be connected to a TV or amplifier.

With the HDMI connection, high definition video and high quality audio formats adopted by Blu-ray disc players (Dolby Digital Plus, Dolby TrueHD, DTS-HD, DTS-HD Master Audio) can be transmitted, which is not possible with the analog video transmission.

Furthermore, in the HDMI connection, audio and video signals can be transmitted through a single HDMI cable, while in conventional connections it is necessary to provide audio and video cables separately for connection between devices.

This allows you to simplify the wiring configuration that tends to be quite complex in a home theater system.

This unit supports the following HDMI functions.

- **Deep Color**

An imaging technology supported by HDMI. Unlike RGB or YCbCr, which uses 8 bits (256 shades) per color, it can use 10 bits (1024 shades), 12 bits (4096 shades), or 16 bits (65536 shades) to produce colors in higher definition. Both devices linked via HDMI must support Deep Color.

- **“x.v.Color”**

This function lets HDTVs display colors more accurately. It enables display with natural, vivid colors.

“x.v.Color” is trademark of Sony Corporation.

- **3D**

This unit supports input and output of 3D (3 dimensional) video signals of HDMI.

To play back 3D video, you need a TV and player that provide support for the HDMI 3D function and a pair of 3D glasses.

- **4K**

This unit supports input and output of 4K Ultra HD (3840 x 2160 pixels) video signals of HDMI.

- **Content Type**

It automatically makes settings suitable for the video output type (content information).

- **Adobe RGB color, Adobe YCC601 color**

The color space defined by Adobe Systems Inc. Because it is a wider color space than RGB, it can produce more vivid and natural images.

- **sYCC601 color**

Each of these color spaces defines a palette of available colors that is larger than the traditional RGB color model.

- **Auto Lip Sync**

This function can automatically correct delay between the audio and video.

Use a TV that is compatible with the Auto Lip Sync function.

- **HDMI pass through**

Even when the power to this unit is set to standby, signals input from the HDMI input connector are output to a TV or other device that is connected to the HDMI output connector.



• HDMI control

If you connect the unit and an HDMI control function compatible TV or player with an HDMI cable and then enable the HDMI control function setting on each device, the devices will be able to control each other.

• Power off link

This unit power off can be linked to the TV power off step.

• Audio output destination switching

From the TV, you can switch whether to output audio from the TV or the AV amplifier.

• Volume adjustment

You can adjust this unit's volume in the TV volume adjustment operation.

• Input source switching

You can switch this unit input sources through linkage to TV input switching.

When playing the player, this unit input source switches to the source for that player.

• ARC (Audio Return Channel)

This function transmits audio signals from the TV to this unit through the HDMI cable and plays back the audio from the TV on this unit based on the HDMI control function.

If a TV without the ARC function is connected via HDMI connections, video signals of the playback device connected to this unit are transmitted to the TV, but this unit can not play back the audio from the TV. If you want to enjoy surround audio for TV program, a separate audio cable connection is required. In contrast, if a TV with the ARC function is connected via HDMI connections, no audio cable connection is required. Audio signals from the TV can be input to this unit through the HDMI cable between this unit and the TV. This function allows you to enjoy surround playback on this unit for the TV.



■ Supported audio formats

2-channel Linear PCM	2-channel, 32 kHz – 192 kHz, 16/20/24 bit
Multi-channel Linear PCM	7.1-channel, 32 kHz – 192 kHz, 16/20/24 bit
Bitstream	Dolby Digital / DTS / Dolby TrueHD / Dolby Digital Plus / DTS-HD Master Audio / DTS-HD High Resolution Audio / DTS Express

■ Supported video signals

- 480i
- 480p
- 576p
- 720p 60/50Hz
- 1080p 60/50/24Hz
- 4K 30/25/24Hz
- 576i
- 1080i 60/50Hz

Copyright protection system

In order to play back digital video and audio such as BD-Video (Blu-ray Disc) or DVD-Video via HDMI connection, both this unit and TV and the player need to support the copyright protection system known as HDCP (High-bandwidth Digital Content Protection System). HDCP is copyright protection technology comprised of data encryption and authentication of the connected AV devices. This unit supports HDCP.

- If a device that does not support HDCP is connected, video and audio are not output correctly. Read the owner's manual of your television or player for more information.



- When connecting this unit to a device that is compatible with the Deep Color, 4K, ARC function, use a "High Speed HDMI cable with Ethernet".



Video conversion function

This unit automatically converts the input video signals as shown in the diagram below before outputting them to the TV.

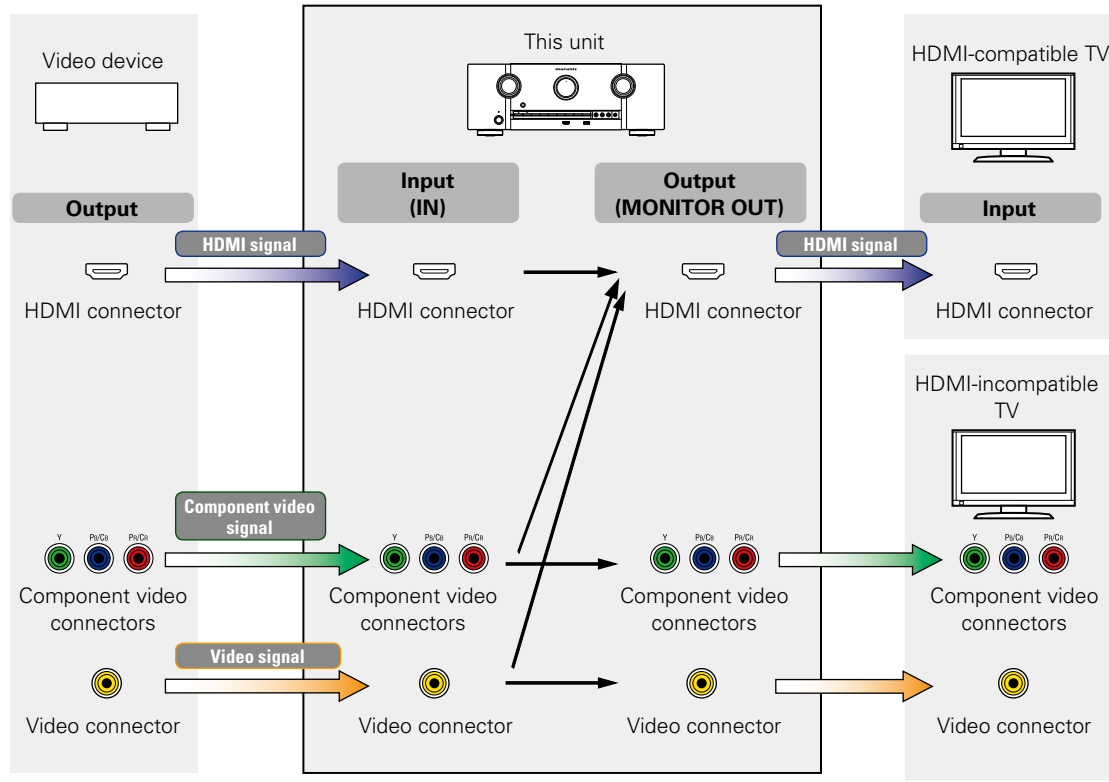

- The main zone video conversion function is compatible with the following formats: NTSC, PAL, SECAM, NTSC4.43, PAL-N, PAL-M and PAL-60.



This unit can convert the input video signals to the resolution that is set for "Resolution" (see page 152) in the menu before outputting them to the TV.

Input signal \ Output signal		HDMI						
		480i/576i	480p/576p	720p	1080i	1080p	1080p 24Hz	4K 30/25/24Hz
HDMI	480i/576i	✓	✓	✓	✓	✓	✓	✓
	480p/576p		✓	✓	✓	✓	✓	✓
	720p			✓	✓	✓	✓	✓
	1080i			✓	✓	✓	✓	✓
	1080p 24Hz					✓	✓	✓
	1080p					✓	✓	✓
	4K 30/25/24Hz							✓
Component Video	480i/576i	✓	✓	✓	✓	✓	✓	✓
	480p/576p		✓	✓	✓	✓	✓	✓
	720p			✓	✓	✓	✓	✓
	1080i			✓	✓	✓	✓	✓
	1080p					✓	✓	✓
Video	480i/576i	✓	✓	✓	✓	✓	✓	✓



Playing back USB memory devices

- This unit is compatible with MP3 ID3-Tag (Ver. 2) standard.
- This unit can show the artwork that was embedded by using MP3 ID3-Tag Ver. 2.3 or 2.4.
- This unit is compatible with WMA META tags.
- If the image size (pixels) of an album artwork exceeds 500 × 500 (WMA/MP3/WAV/FLAC) or 349 × 349 (MPEG-4 AAC), then music may not be played back properly.

Compatible formats

	Sampling frequency	Bit rate	Extension
WMA (Windows Media Audio)*1	32/44.1/48 kHz	48 – 192 kbps	.wma
MP3 (MPEG-1 Audio Layer-3)	32/44.1/48 kHz	32 – 320 kbps	.mp3
WAV	32/44.1/48/88.2/96/ 176.4/192 kHz	–	.wav
MPEG-4 AAC *2	32/44.1/48 kHz	16 – 320 kbps	.aac/ .m4a/ .mp4
FLAC (Free Lossless Audio Codec)	32/44.1/48/88.2/96/ 176.4/192 kHz	–	.flac
ALAC (Apple Lossless Audio Codec)*3	32/44.1/48/88.2/96 kHz	–	.m4a

- *1 Copyright-protected files can be played on certain portable players compatible with MTP.
- *2 Only files that are not protected by copyright can be played on this unit. Content downloaded from pay sites on the Internet are copyright protected. Also, files encoded in WMA format when ripped from a CD, etc. on a computer may be copyright protected, depending on the computer's settings.
- *3 Copyright [2012] [D&M Holdings, Inc.]
Licensed under the Apache License, Version 2.0 (the "License"); you may not use this file except in compliance with the License. You may obtain a copy of the License at <http://www.apache.org/licenses/LICENSE-2.0>.

Maximum Number of Playable Files and Folder

The limits on the number of folders and files that can be displayed by this unit are as follows.

Item	Media	USB memory devices
Memory capacity		FAT16 : 2 GB, FAT32 : 2 TB
Number of folder directory levels*1		8 levels
Number of folders		500
Number of files*2		5000

*1 The limited number includes the root folder.

*2 The allowable number of files may differ according to the USB memory device capacity and the file size.



Playing back files stored on PC or NAS

- This unit is compatible with MP3 ID3-Tag (Ver. 2) standard.
- This unit can show the artwork that was embedded by using MP3 ID3-Tag Ver. 2.3 or 2.4.
- This unit is compatible with WMA META tags.
- If the image size (pixels) of an album artwork exceeds 500 × 500 (WMA/MP3/WAV/FLAC) or 349 × 349 (MPEG-4 AAC), then music may not be played back properly.
- A server or server software compatible with distribution in the corresponding formats is required to play music files via a network.

■ Specifications of supported files

	Sampling frequency	Bit rate	Extension
WMA (Windows Media Audio)	32/44.1/48 kHz	48 – 192 kbps	.wma
MP3 (MPEG-1 Audio Layer-3)	32/44.1/48 kHz	32 – 320 kbps	.mp3
WAV	32/44.1/48/88.2/96/ 176.4/192 kHz	–	.wav
MPEG-4 AAC*1	32/44.1/48 kHz	16 – 320 kbps	.aac/ .m4a/ .mp4
FLAC (Free Lossless Audio Codec)	32/44.1/48/88.2/96/ 176.4/192 kHz	–	.flac
ALAC (Apple Lossless Audio Codec)*2	32/44.1/48/88.2/96 kHz	–	.m4a

*1 Only files that are not protected by copyright can be played on this unit. Content downloaded from pay sites on the Internet are copyright protected. Also, files encoded in WMA format when ripped from a CD, etc. on a computer may be copyright protected, depending on the computer's settings.

*2 Copyright [2012] [D&M Holdings, Inc.]
Licensed under the Apache License, Version 2.0 (the "License"); you may not use this file except in compliance with the License. You may obtain a copy of the License at <http://www.apache.org/licenses/LICENSE-2.0>.



Playing back Internet Radio

■ Playable broadcast station specifications

	Sampling frequency	Bit rate	Extension
WMA (Windows Media Audio)	32/44.1/48 kHz	48 – 192 kbps	.wma
MP3 (MPEG-1 Audio Layer-3)	32/44.1/48 kHz	32 – 320 kbps	.mp3
MPEG-4 AAC	32/44.1/48 kHz	16 – 320 kbps	.aac/ .m4a/ .mp4

Personal memory plus function

This function sets the settings (input mode, sound mode, HDMI output mode, MultEQ® XT, Dynamic EQ, audio delay etc.) last selected for the individual input sources.



- The surround parameters, tone control settings are stored for the individual sound modes.

Last function memory

This function stores the settings which were made before going into the standby mode.

When the power is turned back on, the settings are restored.



Sound modes and channel output

- This indicates the audio output channels or surround parameters that can be set.
 ◎ This indicates the audio output channels. The output channels depend on the settings of “Speaker Config.” (☞ [page 168](#)).

Sound mode (☞ page 107)	Channel output					
	Front L/R	Center	Surround L/R	Surround back L/R	Front height L/R	Subwoofer
DIRECT/PURE DIRECT (2-channel)	○					◎*3
DIRECT/PURE DIRECT (Multi-channel)	○	◎	◎	◎*1	◎*1	◎
STEREO	○					◎
MULTI CH IN	○	◎	◎	◎*1		◎
DOLBY PRO LOGIC IIz	○	◎	◎		◎*2	◎
DOLBY PRO LOGIC IIx	○	◎	◎	◎		◎
DOLBY PRO LOGIC II	○	◎	◎			◎
DTS NEO:6	○	◎	◎	◎		◎
DOLBY DIGITAL	○	◎	◎	◎	◎*2	◎
DOLBY DIGITAL Plus	○	◎	◎	◎*1	◎*1	◎
DOLBY TrueHD	○	◎	◎	◎*1	◎*1	◎
DTS SURROUND	○	◎	◎	◎	◎*2	◎
DTS 96/24	○	◎	◎	◎	◎*2	◎
DTS-HD	○	◎	◎	◎*1	◎*1	◎
DTS Express	○	◎	◎	◎	◎*2	◎
MULTI CH STEREO	○	◎	◎	◎	◎	◎
VIRTUAL	○					◎

- *1 A signal for each channel contained in an input signal is output as audio.
 *2 Audio is output when the set surround mode name contains “+PLIIz”.
 *3 Audio is output when “Subwoofer Mode” (☞ [page 172](#)) in the menu is set to “LFE+Main”.



Sound modes and surround parameters

Sound mode (☞ page 107)	Surround Parameter (☞ page 140)						
	Dialog Level (☞ page 139)	Subwoofer Level (☞ page 139)	Home Theater EQ (☞ page 140)	Loudness Management *1 (☞ page 140)	Dynamic Compression *2 (☞ page 140)	Low Frequency Effects *3 (☞ page 141)	Height Gain *4 (☞ page 142)
DIRECT/PURE DIRECT (2-channel)*5		○*6		○	○		
DIRECT/PURE DIRECT (Multi-channel)*5	○	○		○	○		
STEREO		○		○	○	○	
MULTI CH IN	○	○	○			○	○
DOLBY PRO LOGIC IIz	○	○	○	○	○		○
DOLBY PRO LOGIC IIx	○	○	○	○	○		
DOLBY PRO LOGIC II	○	○	○	○	○		
DTS NEO:6	○	○	○	○	○		
DOLBY DIGITAL	○	○	○		○	○	○
DOLBY DIGITAL Plus	○	○	○		○	○	○
DOLBY TrueHD	○	○	○	○	○	○	○
DTS SURROUND	○	○	○		○	○	○
DTS 96/24	○	○	○			○	○
DTS-HD	○	○	○			○	○
DTS Express	○	○	○			○	○
MULTI CH STEREO	○	○	○	○	○	○	
VIRTUAL		○		○	○	○	

*1 - *6 : ☞ page 212



Sound mode (🔗 page 107)	Surround Parameter (🔗 page 140)				Tone *7 (🔗 page 143)	Audyssey (🔗 page 145)			M-DAX *10 (🔗 page 143)
	PRO LOGIC II/IIx Music mode only			NEO:6 Music mode only		MultEQ® XT *8 (🔗 page 145)	Dynamic EQ *9 (🔗 page 145)	Dynamic Volume *9 (🔗 page 146)	
	Panorama (🔗 page 141)	Dimension (🔗 page 141)	Center Width (🔗 page 142)	Center Image (🔗 page 141)					
DIRECT/PURE DIRECT (2-channel)*5									
DIRECT/PURE DIRECT (Multi-channel)*5									
STEREO					○	○	○	○	○
MULTI CH IN					○	○	○	○	
DOLBY PRO LOGIC IIz					○	○	○	○	○
DOLBY PRO LOGIC IIx	○	○	○		○	○	○	○	○
DOLBY PRO LOGIC II	○	○	○		○	○	○	○	○
DTS NEO:6				○	○	○	○	○	○
DOLBY DIGITAL					○	○	○	○	
DOLBY DIGITAL Plus					○	○	○	○	
DOLBY TrueHD					○	○	○	○	
DTS SURROUND					○	○	○	○	
DTS 96/24					○	○	○	○	
DTS-HD					○	○	○	○	
DTS Express					○	○	○	○	
MULTI CH STEREO					○	○	○	○	○
VIRTUAL					○	○	○	○	○

*5, *7 – *10 : 🔗 page 212



- *1 This item can be selected when a Dolby TrueHD signal is played.
- *2 This item can be selected when a Dolby Digital or DTS signal is played.
- *3 This item can be selected when a Dolby Digital or DTS signal or DVD-Audio is played.
- *4 This setting is available when the set sound mode name contains "+PLIIz".
- *5 During playback in PURE DIRECT mode, the surround parameters are the same as in DIRECT mode.
- *6 Audio is output when "Subwoofer Mode" ([page 172](#)) in the menu is set to "LFE+Main".
- *7 This item cannot be set when "Dynamic EQ" ([page 145](#)) is set to "On".
- *8 This item cannot be set when Audyssey® Setup (Speaker Calibration) has not been performed.
- *9 This item cannot be set when "MultEQ® XT" ([page 145](#)) is set to "Off" or "Graphic EQ".
- *10 This item can be set when the input signal is analog, PCM 48 kHz or 44.1 kHz.



Types of input signals, and corresponding sound modes

- This indicates the default sound mode.
- This indicates the selectable sound mode.

Sound mode (☞ page 107)	NOTE	2-channel signal		Multi-channel signal									
		Analog / PCM	Dolby Digital (+/HD) / DTS (+HD)	PCM Multi	DTS-HD	DTS Express	DTS ES DSCRT 6.1	DTS ES MTRIX 6.1	DTS	DOLBY TrueHD	DOLBY DIGITAL Plus	DOLBY DIGITAL EX	DOLBY DIGITAL
DTS SURROUND													
DTS-HD MSTR					●*6								
DTS-HD HI RES					●*7								
DTS ES DSCRT6.1	*1						●						
DTS ES MTRX6.1	*1							●					
DTS SURROUND													
DTS 96/24												●*8	
DTS (-HD) + PLIIx	*1*2				○	○						○	
DTS (-HD) + PLIIz	*3				○	○	○	○				○	
DTS Express									●				
DTS NEO:6	*4	○	○										
DOLBY SURROUND													
DOLBY TrueHD												●	
DOLBY DIGITAL+												●	
DOLBY DIGITAL EX	*1											○	○
DOLBY (D+) (HD) +EX	*1									○	○		
DOLBY DIGITAL												●	●
DOLBY (D) (D+) (HD) + PLIIx	*1*2									○	○	○	○
DOLBY (D) (D+) (HD) + PLIIz	*3									○	○	○	○
DOLBY PRO LOGIC II/IIx	*5	○	○										
DOLBY PRO LOGIC IIz	*3	○	○										

*1 - *8 : ☞ page 215



Sound mode (☞ page 107)	NOTE	2-channel signal		Multi-channel signal									
		Analog / PCM	Dolby Digital (+/HD) / DTS (-HD)	PCM Multi	DTS-HD	DTS Express	DTS ES DSCRT 6.1	DTS ES MTRIX 6.1	DTS	DOLBY TrueHD	DOLBY DIGITAL Plus	DOLBY DIGITAL EX	DOLBY DIGITAL
MULTI CH IN													
MULTI CH IN				●									
MULTI CH IN + DOLBY EX	*1			○									
MULTI CH IN + PLIIx	*1*2			○									
MULTI CH IN + PLIIz	*3			○									
MULTI CH IN 7.1	*1			●*10									
DIRECT													
DIRECT		○*9	○	○	○	○	○	○	○	○	○	○	○
PURE DIRECT													
PURE DIRECT		○	○	○	○	○	○	○	○	○	○	○	○
DSP SIMULATION													
MULTI CH STEREO		○	○	○	○	○	○	○	○	○	○	○	○
VIRTUAL		○	○	○	○	○	○	○	○	○	○	○	○
STEREO													
STEREO		○	○	○	○	○	○	○	○	○	○	○	○

*1 - *3, *9, *10 : ☞ page 215



- *1 This item can be selected when surround back speakers are used.
- *2 The Movie mode or Music mode can be selected. When using a single surround back speaker, the Music mode is used.
- *3 This item can be selected when front height speakers are used.
- *4 The Cinema mode or Music mode can be selected.
- *5 The Movie mode, Music mode or Game mode can be selected.
- *6 This item can be selected when the input signal is DTS-HD MASTER AUDIO.
- *7 This item can be selected when the input signal is DTS-HD HI RESOLUTION.
- *8 This item can be selected when the input signal is DTS 96/24.
- *9 The default sound mode for the AirPlay playback is DIRECT. (Default)
- *10 This item can be selected when the input signals contain surround back signals.



Explanation of terms

A

A2DP

A2DP is one profile of Bluetooth defined for in-car devices or AV devices that use wireless communication instead of a cable.

AirPlay

AirPlay sends (plays) contents recorded in iTunes or on an iPhone/iPod touch/iPad to a compatible device via the network.

ALAC (Apple Lossless Audio Codec)

This is a codec for lossless audio compression method developed by Apple Inc. This codec can be played back on iTunes, iPod or iPhone. Data compressed to approximately 60 – 70 % can be decompressed to exactly the same original data.

App Store

App Store is a site that sells application software for such devices as the iPhone or iPod Touch, and is operated by Apple Inc.

Audyssey Dynamic EQ®

Dynamic EQ solves the problem of deteriorating sound quality as volume is decreased by taking into account human perception and room acoustics. Audyssey Dynamic EQ® works in tandem with Audyssey MultEQ® XT to provide well-balanced sound for every listener at any volume level.

Audyssey Dynamic Volume®

Dynamic Volume solves the problem of large variations in volume level between television programs, commercials, and between the soft and loud passages of movies. Audyssey Dynamic EQ® is integrated into Dynamic Volume so that as the playback volume is adjusted automatically, the perceived bass response, tonal balance, surround impression, and dialog clarity remain the same.

Audyssey MultEQ® XT

MultEQ® XT is a room equalization solution that calibrates any audio system so that it can achieve optimum performance for every listener in a large listening area. Based on several room measurements, MultEQ® XT calculates an equalization solution that corrects for both time and frequency response problems in the listening area and also performs a fully automated surround system setup.

B

Bluetooth

Bluetooth is a short-distance wireless communication technology used for connecting handheld devices several meters apart. This enables notebook computers, PDA s, mobile phones, etc. to connect without a cable for transmitting audio and data.



D

DLNA

DLNA and DLNA CERTIFIED are trademarks and/or service marks of Digital Living Network Alliance.

Some contents may not be compatible with other DLNA CERTIFIED® products.

Dolby Digital

Dolby Digital is a multi-channel digital signal format developed by Dolby Laboratories.

A total of 5.1-channels are played: 3 front channels (“FL”, “FR” and “C”), 2 surround channels (“SL” and “SR”) and the “LFE” channel for low frequency effects.

Because of this, there is no crosstalk between channels and a realistic sound field with a “three-dimensional” feeling (sense of distance, movement and positioning) is achieved. This delivers a thrilling surround sound experience in the home.

Dolby Digital EX

Dolby Digital EX is a 6.1-channel surround format from Dolby Laboratories that allows users to enjoy in their homes the “DOLBY DIGITAL SURROUND EX” audio format jointly developed by Dolby Laboratories and Lucasfilm. The 6.1-channels of sound, including surround back channel, provide improved sound positioning and expansion of the surround sound field.

Dolby Digital Plus

Dolby Digital Plus is an improved Dolby Digital signal format that is compatible with up to 7.1-channels of discrete digital sound and also improves sound quality thanks to extra data bit rate performance. It is upwardly compatible with conventional Dolby Digital, so it offers greater flexibility in response to the source signal and the conditions of the playback device.

Dolby Pro Logic II

Dolby Pro Logic II is a matrix decoding technology developed by Dolby Laboratories.

Regular music such as that on CDs is encoded into 5-channels to achieve an excellent surround effect.

The surround channel signals are converted into stereo and full band signals (with a frequency response of 20 Hz to 20 kHz or greater) to create a “three-dimensional” sound image offering a rich sense of presence for all stereo sources.

Dolby Pro Logic IIx

Dolby Pro Logic IIx is a further improved version of the Dolby Pro Logic II matrix decoding technology.

Audio signals recorded in 2-channels are decoded to achieve a natural sound with up to 7.1-channels.

There are three modes: “Music” suited for playing music, “Movie” suited for playing movies, and “Game” which is optimized for playing games.



Dolby Pro Logic IIz

Dolby Pro Logic IIz introduces a new dimension to Home Entertainment through the addition of a pair of front height channels. Compatible with stereo, 5.1-channel and 7.1-channel content, Dolby Pro Logic IIz provides enhanced spaciousness, depth and dimension to movies, concert video and video game playback while maintaining the full integrity of the source mix.

Dolby Pro Logic IIz identifies and decodes spatial cues that occur naturally in all content, directing this information to the front height channels, complementing the performance of left and right surround sound speakers. Content that is encoded with Dolby Pro Logic IIz height channel information can be even more revealing, with perceptually discrete height channel information bringing an exciting new dimension to home entertainment.

Dolby Pro Logic IIz, with front height channels is also an ideal alternative for households that cannot support the placement of back surround speakers of a typical 7.1-channel system but may have bookshelf space available to support the addition of height speakers.

Dolby TrueHD

Dolby TrueHD is a high definition audio technology developed by Dolby Laboratories, using lossless coding technology to faithfully reproduce the sound of the studio master.

This format provides the facility to support up to 8 audio channels with a sampling frequency of 96 kHz/24 bit resolution and up to 6 audio channels with a sampling frequency of 192 kHz/24 bit resolution. Dolby TrueHD is adopted for applications that put very high importance on sound quality.

Downmix

This function converts the number of channels of surround audio to a lower number of channels and plays back according to the system's configuration.

DTS

This is an abbreviation of Digital Theater System, which is a digital audio system developed by DTS.

DTS delivers a powerful and dynamic surround sound experience, and is found in the world's finest movie theaters and screening rooms.

DTS 96/24

DTS 96/24 is a digital audio format enabling high sound quality playback in 5.1-channels with a sampling frequency of 96 kHz and 24 bit quantization on DVD-Video.



DTS Digital Surround

DTS Digital Surround is the standard digital surround format of DTS, Inc., compatible with a sampling frequency of 44.1 or 48 kHz and up to 5.1-channels of digital discrete surround sound.

DTS-ES™ Discrete 6.1

DTS-ES™ Discrete 6.1 is a 6.1-channel discrete digital audio format adding a surround back (SB) channel to the DTS digital surround sound.

Decoding of conventional 5.1-channel audio signals is also possible according to the decoder.

DTS-ES™ Matrix 6.1

DTS-ES™ Matrix 6.1 is a 6.1-channel audio format that inserts a surround back (SB) channel to the DTS digital surround sound through matrix encoding. Decoding of conventional 5.1-channel audio signals is also possible according to the decoder.

DTS Express

DTS Express is an audio format supporting low bit rates (max. 5.1-channels, 24 to 256 kbps).

DTS-HD

This audio technology provides higher sound quality and enhanced functionality than the conventional DTS and is adopted as an optional audio for Blu-ray Disc. This technology supports multi-channel, high data transfer speed, high sampling frequency, and lossless audio playback. Maximum 7.1-channels are supported in Blu-ray Disc.

DTS-HD High Resolution Audio

DTS-HD High Resolution Audio is an improved version of the conventional DTS, DTS-ES and DTS 96/24 signals formats, compatible with sampling frequencies of 96 or 48 kHz and up to 7.1-channels of discrete digital sound. High data bit rate performance provides high quality sound. This format is fully compatible with conventional products, including conventional DTS digital surround 5.1-channel data.

DTS-HD Master Audio

DTS-HD Master Audio is a lossless audio format created by Digital Theater System (DTS). This format provides the facility to support up to 8 audio channels with a sampling frequency of 96 kHz/24 bit resolution and up to 6 audio channels with a sampling frequency of 192 kHz/24 bit resolution. It is fully compatible with conventional products, including conventional DTS digital surround 5.1-channel data.

DTS NEO:6™ Surround

DTS NEO:6™ is a matrix decoding technology for achieving 6.1-channel surround playback with 2-channel sources. It includes “DTS NEO:6 Cinema” suited for playing movies and “DTS NEO:6 Music” suited for playing music.

Dynamic range

The difference between the maximum undistorted sound level and the minimum discernible level above the noise emitted by the device.



F

FLAC

FLAC stands for Free lossless Audio Codec, and is a lossless free audio file format. Lossless means that the audio is compressed without any loss in quality.

The FLAC license is as shown below.

Copyright (C) 2000, 2001, 2002, 2003, 2004, 2005, 2006, 2007, 2008, 2009 Josh Coalson

Redistribution and use in source and binary forms, with or without modification, are permitted provided that the following conditions are met:

- Redistributions of source code must retain the above copyright notice, this list of conditions and the following disclaimer.
- Redistributions in binary form must reproduce the above copyright notice, this list of conditions and the following disclaimer in the documentation and/or other materials provided with the distribution.
- Neither the name of the Xiph.org Foundation nor the names of its contributors may be used to endorse or promote products derived from this software without specific prior written permission.

THIS SOFTWARE IS PROVIDED BY THE COPYRIGHT HOLDERS AND CONTRIBUTORS "AS IS" AND ANY EXPRESS OR IMPLIED WARRANTIES, INCLUDING, BUT NOT LIMITED TO, THE IMPLIED WARRANTIES OF MERCHANTABILITY AND FITNESS FOR A PARTICULAR PURPOSE ARE DISCLAIMED. IN NO EVENT SHALL THE FOUNDATION OR CONTRIBUTORS BE LIABLE FOR ANY DIRECT, INDIRECT, INCIDENTAL, SPECIAL, EXEMPLARY, OR CONSEQUENTIAL DAMAGES (INCLUDING, BUT NOT LIMITED TO, PROCUREMENT OF SUBSTITUTE GOODS OR SERVICES; LOSS OF USE, DATA, OR PROFITS; OR BUSINESS INTERRUPTION) HOWEVER CAUSED AND ON ANY THEORY OF LIABILITY, WHETHER IN CONTRACT, STRICT LIABILITY, OR TORT (INCLUDING NEGLIGENCE OR OTHERWISE) ARISING IN ANY WAY OUT OF THE USE OF THIS SOFTWARE, EVEN IF ADVISED OF THE POSSIBILITY OF SUCH DAMAGE.

H

HDCP

When transmitting digital signals between devices, this copyright protection technology encrypts the signals to prevent content from being copied without authorization.

I

iTunes

iTunes is the name of the multimedia player provided by Apple Inc. It enables management and playback of multimedia contents including music and movies. iTunes supports many main file formats including AAC, WAV, and MP3.



L

LFE

This is an abbreviation of Low Frequency Effect, which is an output channel that emphasizes low frequency effect sound. Surround audio is intensified by outputting 20 Hz to 120 Hz deep bass to the system subwoofer(s).

M

MAIN ZONE

The room where this unit is placed is called the MAIN ZONE.

Modem

Device that connects to your broadband internet provider, and is very often supplied with the service.

A type that is integrated with a router is also often available.

MP3 (MPEG Audio Layer-3)

This is an internationally standardized audio data compression scheme, using the "MPEG-1" video compression standard. It compresses the data volume to about one eleventh its original size while maintaining sound quality equivalent to a music CD.

MPEG (Moving Picture Experts Group),**MPEG-2, MPEG-4**

These are the names for digital compression format standards used for the encoding of video and audio. Video standards include "MPEG-1 Video", "MPEG-2 Video", "MPEG-4 Visual", "MPEG-4 AVC". Audio standards include "MPEG-1 Audio", "MPEG-2 Audio", "MPEG-4 AAC".

P

Pairing

Pairing is an operation required for settings to connect two Bluetooth devices. Pairing enables Bluetooth devices to access each other.

Progressive (sequential scanning)

This is a scanning system of the video signal that displays 1 frame of video as one image. Compared to the interlace system, this system provides images with less flickering and jagged edges.

Protection circuit

This is a function to prevent damage to devices within the power supply when an abnormality such as an overload, excess voltage occurs or over temperature for any reason.

In this unit, the power indicator blinks and the unit enters standby mode when an abnormality occurs.

S

Sampling frequency

Sampling involves taking a reading of a sound wave (analog signal) at regular intervals and expressing the height of the wave at each reading in digitized format (producing a digital signal).

The number of readings taken in one second is called the "sampling frequency". The larger the value, the closer the reproduced sound is to the original.

Speaker impedance

This is an AC resistance value, indicated in Ω (Ohms). Greater power can be obtained when this value is smaller.



V

vTuner

This is a free online content server for Internet Radio. Note that usage fees are included in upgrade costs.

For inquiries about this service, visit the vTuner site below.

vTuner website: <http://www.radiomartantz.com>

This product is protected by certain intellectual property rights of Nothing Else Matters Software and BridgeCo. Use or distribution of such technology outside of this product is prohibited without a license from Nothing Else Matters Software and BridgeCo or an authorized subsidiary.

W

Windows Media DRM

This is a copyright protection technology developed by Microsoft. Content providers are using the digital rights management technology for Windows Media contained in this device (WM-DRM) to protect the integrity of their content (Secure Content) so that their intellectual property, including copyright, in such content is not misappropriated. This device uses WM-DRM software to play Secure Content (WM-DRM Software). If the security of the WM-DRM Software in this device has been compromised, owners of Secure Content (Secure Content Owners) may request that Microsoft revoke the WM-DRM Software's right to acquire new licenses to copy, display and/or play Secure Content. Revocation does not alter the WM-DRM Software's ability to play unprotected content. A list of revoked WM-DRM Software is sent to your device whenever you download a license for Secure Content from the Internet or from a PC. Microsoft may, in conjunction with such license, also download revocation list onto your device on behalf of Secure Content Owners.

Windows Media Player Ver.11 or later

This is a media player distributed free of charge by Microsoft Corporation. It can play playlists created with Ver.11 or later of Windows Media Player, as well as WMA, DRM WMA, WAV, and other files.

WMA (Windows Media Audio)

This is audio compression technology developed by Microsoft Corporation. WMA data can be encoded using Windows Media® Player.

To encode WMA files, only use applications authorized by Microsoft Corporation. If you use an unauthorized application, the file may not work properly.

Z

ZONE2

This unit can operate in a room other than the room where this unit is placed (MAIN ZONE) (ZONE2 playback). The room for ZONE2 playback is called ZONE2.



Trademark information



Manufactured under license from Audyssey Laboratories™. U.S. and foreign patents pending. Audyssey MultEQ® XT, Audyssey Dynamic EQ® and Audyssey Dynamic Volume® are registered trademarks of Audyssey Laboratories.



Manufactured under license from Dolby Laboratories. “Dolby”, “Pro Logic” and the double-D symbol are trademarks of Dolby Laboratories.



Manufactured under license under U.S. Patent Nos: 5,956,674; 5,974,380; 6,226,616; 6,487,535; 7,212,872; 7,333,929; 7,392,195; 7,272,567 & other U.S. and worldwide patents issued & pending. DTS-HD, the Symbol, & DTS-HD and the Symbol together are registered trademarks & DTS-HD Master Audio is a trademark of DTS, Inc. Product includes software. © DTS, Inc. All Rights Reserved.

HDMI

The terms HDMI and HDMI High-Definition Multimedia Interface, and the HDMI Logo are trademarks or registered trademarks of HDMI Licensing LLC in the United States and other countries.



“Made for iPod” and “Made for iPhone” mean that an electronic accessory has been designed to connect specifically to iPod, or iPhone, respectively, and has been certified by the developer to meet Apple performance standards.

Apple is not responsible for the operation of this device or its compliance with safety and regulatory standards. Please note that the use of this accessory with iPod, or iPhone, may affect wireless performance.

AirPlay, the AirPlay logo, iPad, iPhone, iPod, iPod classic, iPod nano, iPod shuffle and iPod touch are trademarks of Apple Inc., registered in the U.S. and other countries.

- Individual users are permitted to use iPhone, iPod, iPod classic, iPod nano, iPod shuffle, and iPod touch for private copy and playback of non-copyrighted contents and contents whose copy and playback is permitted by law. Copyright infringement is prohibited by law.





Windows Media and the Windows logo are trademarks or registered trademarks of Microsoft Corporation in the United States and/or other countries.



Adobe, the Adobe logo and Reader are either registered trademarks or trademarks of Adobe Systems Incorporated in the United States and/or other countries.



Specifications

■ Audio section

• Power amplifier

Rated output:

Front:

100 W + 100 W (8 Ω /ohms, 20 Hz – 20 kHz with 0.08 % T.H.D.)

140 W + 140 W (6 Ω /ohms, 1 kHz with 0.7 % T.H.D.)

Center:

100 W (8 Ω /ohms, 20 Hz – 20 kHz with 0.08 % T.H.D.)

140 W (6 Ω /ohms, 1 kHz with 0.7 % T.H.D.)

Surround:

100 W + 100 W (8 Ω /ohms, 20 Hz – 20 kHz with 0.08 % T.H.D.)

140 W + 140 W (6 Ω /ohms, 1 kHz with 0.7 % T.H.D.)

Surround back:

100 W + 100 W (8 Ω /ohms, 20 Hz – 20 kHz with 0.08 % T.H.D.)

140 W + 140 W (6 Ω /ohms, 1 kHz with 0.7 % T.H.D.)

6 – 16 Ω /ohms

Output connectors:

• Analog

Input sensitivity/Input impedance:

200 mV/47 k Ω /kohms

Frequency response:

10 Hz – 100 kHz — +1, –3 dB (DIRECT mode)

S/N:

100 dB (IHF–A weighted, DIRECT mode)



■ Video section

• Standard video connectors

Input/output level and impedance:	1 V _{p-p} , 75 Ω/ohms
Frequency response:	5 Hz – 10 MHz — 0, –3 dB

• Color component video connector

Input/output level and impedance:	Y signal — 1 V _{p-p} , 75 Ω/ohms
	P _B / C _B signal — 0.7 V _{p-p} , 75 Ω/ohms
	P _R / C _R signal — 0.7 V _{p-p} , 75 Ω/ohms
Frequency response:	5 Hz – 60 MHz — 0, –3 dB

■ Tuner section

Receiving Range:

Usable Sensitivity:

50 dB Quieting Sensitivity:

S/N :

Total harmonic Distortion:

[FM]

(Note: μV at 75 Ω/ohms, 0 dBf = 1 x 10⁻¹⁵ W)

	87.5 MHz – 107.9 MHz
	1.2 μV (12.8 dBf)
MONO	2.8 μV (20.2 dBf)
MONO	70 dB (IHF–A weighted, DIRECT mode)
STEREO	67 dB (IHF–A weighted, DIRECT mode)
MONO	0.7 % (1 kHz)
STEREO	1.0 % (1 kHz)

[AM]

	520 kHz – 1710 kHz
	18 μV

■ General

Power supply:	AC 120 V, 60 Hz
Power consumption:	650 W
Power consumption in standby mode:	0.2 W
Power consumption in CEC standby mode:	0.5 W
Power consumption in network standby mode:	2.7 W

For purposes of improvement, specifications and design are subject to change without notice.



Index

Numerics

3D	201
4K	201
5.1-channel	24
6.1-channel	23
7.1-channel	23, 24, 28, 29

A

A2DP	47, 216
Accessories	7
Add New Feature	182
Adjusting the master volume	53
AirPlay	96, 216
ALAC	216
AM loop antenna	43
App Store	216
Audio settings	139
Audyssey Dynamic EQ®	216
Audyssey Dynamic Volume®	216
Audyssey MultEQ® XT	216
Audyssey settings	145, 160
Audyssey® Setup	158
Auto Standby	179

B

Bi-amp	30
Bluetooth	47, 216

C

Cables	21
Connection	
7.1CH IN	40
DC OUT	49
DVD player	38
FM/AM	43
Home network (LAN)	45
iPod (USB)	41
Power amplifier	31
Power cord	50
REMOTE CONTROL	48
Set-top box	37
Speaker	25
TV	33, 34, 35
USB memory device	41
Video camcorder	39
Wireless receiver	47
Content Type	201
Convenient function menu	
All Zone Stereo	106
Picture Mode	105
Random	100
Remove from Favorites	102
Repeat	100
Save to Favorites	101
Slideshow	103
Slideshow Interval	104
Text Search	102
Video Select	104

D

Deep Color	201
Display	14
DLNA	217

Dolby

Dolby Digital	111, 217
Dolby Digital EX	111, 217
Dolby Digital Plus	111, 217
Dolby Pro Logic II	111, 217
Dolby Pro Logic IIx	111, 217
Dolby Pro Logic IIz	111, 218
Dolby TrueHD	111, 218
Downmix	218
DTS	218
DTS 96/24	112, 218
DTS Digital Surround	219
DTS-ES Discrete 6.1	112, 219
DTS-ES Matrix 6.1	112, 219
DTS Express	112, 219
DTS-HD	112, 219
DTS-HD High Resolution Audio	219
DTS-HD Master Audio	219
DTS Neo:6	112
DTS NEO:6™ Surround	219
Dual backup memory function	123
Dynamic range	219









E

Error messages (Audyssey® Setup)	165
--	-----

F

Firmware update	181
FLAC	220
Flickr	76
FM/AM	61
FM indoor antenna	43
Front height speaker	23, 29
Front panel	11



 H		 N		 R	
HDCP.....	203, 220	Network settings.....	173	Random.....	57, 100
HDMI control.....	119, 150			Rear panel.....	16
Headphones.....	12	 P		Remote control unit.....	19
		Pairing.....	221	Inserting the batteries.....	8
 I		Pandora®.....	81	Remote lock function.....	126
Information.....	179	Panel lock function.....	124	Repeat.....	57, 100
Audio.....	179	Playback		Resetting factory settings.....	200
Firmware.....	180	ALAC.....	58, 72		
Notifications.....	180	Blu-ray Disc player.....	53	 S	
Video.....	180	DVD player.....	53	Sampling frequency.....	221
ZONE.....	180	FLAC.....	58, 72	Selecting the input source.....	52
Input signal.....	213	Flickr.....	76	SiriusXM.....	87
Inputting characters.....	138	FM/AM.....	62	Sleep timer.....	120
iPod Browse Mode.....	56	Internet Radio.....	68	Sound mode.....	107, 115, 210
iTunes.....	220	iPod (USB).....	54	AUTO.....	113
		JPEG.....	58, 72	DIRECT.....	109, 114
 L		MP3.....	58, 68, 72	Dolby.....	111
LFE.....	221	MPEG-4 AAC.....	58, 68, 72	DTS.....	112
Listening position.....	159	NAS.....	72	Original.....	113
		Pandora®.....	81	PCM multi-channel.....	112
 M		PC.....	72	PURE DIRECT.....	109, 114
MAIN ZONE.....	221	SiriusXM.....	87	STEREO.....	114
Menu map.....	131	Spotify.....	90	Speaker	
Audio.....	131, 139	USB memory device.....	58	Connect.....	25
General.....	135, 177	WAV.....	58, 72	Install.....	22
Inputs.....	134, 154	WMA.....	58, 68, 72	Set up.....	158
Network.....	135, 173	ZONE2.....	129	Speaker impedance.....	221
Setup Assistant.....	136	Protection circuit.....	221	Spotify.....	90
Speakers.....	134, 158			Surround back speaker.....	23, 28
Video.....	133, 148				
Modem.....	221				
MP3.....	221				
MPEG.....	221				



**T**

Tips	186
Troubleshooting	188
Tuner operation menu	
Auto Preset Memory.....	66
Direct Tune.....	63
Preset Memory	65
Preset Name	66
Preset Skip	67
Tune Mode.....	64
Turning off the sound temporarily.....	53
Turning the power on.....	52

**V**

Video conversion.....	204
Video settings	148
vTuner.....	71, 222

**W**

Web control.....	121
Windows Media DRM.....	222
Windows Media Player	222
WMA.....	222

**Z**

ZONE2.....	127, 222
------------	----------



License

This section describes software license used for this unit. To maintain the correct content, the original (English) is used.

□ Boost

<http://www.boost.org/>

Boost Software License - Version 1.0 - August 17th, 2003

Permission is hereby granted, free of charge, to any person or organization obtaining a copy of the software and accompanying documentation covered by this license (the "Software") to use, reproduce, display, distribute, execute, and transmit the Software, and to prepare derivative works of the Software, and to permit third-parties to whom the Software is furnished to do so, all subject to the following:

The copyright notices in the Software and this entire statement, including the above license grant, this restriction and the following disclaimer, must be included in all copies of the Software, in whole or in part, and all derivative works of the Software, unless such copies or derivative works are solely in the form of machine-executable object code generated by a source language processor.

THE SOFTWARE IS PROVIDED "AS IS", WITHOUT WARRANTY OF ANY KIND, EXPRESS OR IMPLIED, INCLUDING BUT NOT LIMITED TO THE WARRANTIES OF MERCHANTABILITY, FITNESS FOR A PARTICULAR PURPOSE, TITLE AND NON-INFRINGEMENT. IN NO EVENT SHALL THE COPYRIGHT HOLDERS OR ANYONE DISTRIBUTING THE SOFTWARE BE LIABLE FOR ANY DAMAGES OR OTHER LIABILITY, WHETHER IN CONTRACT, TORT OR OTHERWISE, ARISING FROM, OUT OF OR IN CONNECTION WITH THE SOFTWARE OR THE USE OR OTHER DEALINGS IN THE SOFTWARE.

□ Expat

<http://www.jclark.com/xml/expat.html>

Expat License. Copyright (c) 1998, 1999, 2000 Thai Open Source Software Center Ltd

Permission is hereby granted, free of charge, to any person obtaining a copy of this software and associated documentation files (the "Software"), to deal in the Software without restriction, including without limitation the rights to use, copy, modify, merge, publish, distribute, sublicense, and/or sell copies of the Software, and to permit persons to whom the Software is furnished to do so, subject to the following conditions:

The above copyright notice and this permission notice shall be included in all copies or substantial portions of the Software.

THE SOFTWARE IS PROVIDED "AS IS", WITHOUT WARRANTY OF ANY KIND, EXPRESS OR IMPLIED, INCLUDING BUT NOT LIMITED TO THE WARRANTIES OF MERCHANTABILITY, FITNESS FOR A PARTICULAR PURPOSE AND NON-INFRINGEMENT. IN NO EVENT SHALL THE AUTHORS OR COPYRIGHT HOLDERS BE LIABLE FOR ANY CLAIM, DAMAGES OR OTHER LIABILITY, WHETHER IN AN ACTION OF CONTRACT, TORT OR OTHERWISE, ARISING FROM, OUT OF OR IN CONNECTION WITH THE SOFTWARE OR THE USE OR OTHER DEALINGS IN THE SOFTWARE.

□ FastDelegate

<http://www.codeproject.com/KB/cpp/FastDelegate.asp>

THE WORK (AS DEFINED BELOW) IS PROVIDED UNDER THE TERMS OF THIS CODE PROJECT OPEN LICENSE ("LICENSE"). THE WORK IS PROTECTED BY COPYRIGHT AND/OR OTHER APPLICABLE LAW. ANY USE OF THE WORK OTHER THAN AS AUTHORIZED UNDER THIS LICENSE OR COPYRIGHT LAW IS PROHIBITED.

BY EXERCISING ANY RIGHTS TO THE WORK PROVIDED HEREIN, YOU ACCEPT AND AGREE TO BE BOUND BY THE TERMS OF THIS LICENSE. THE AUTHOR GRANTS YOU THE RIGHTS CONTAINED HEREIN IN CONSIDERATION OF YOUR ACCEPTANCE OF SUCH TERMS AND CONDITIONS. IF YOU DO NOT AGREE TO ACCEPT AND BE BOUND BY THE TERMS OF THIS LICENSE, YOU CANNOT MAKE ANY USE OF THE WORK.

1. Definitions.

- a. "Articles" means, collectively, all articles written by Author which describes how the Source Code and Executable Files for the Work may be used by a user.
- b. "Author" means the individual or entity that offers the Work under the terms of this License.
- c. "Derivative Work" means a work based upon the Work or upon the Work and other pre-existing works.
- d. "Executable Files" refer to the executables, binary files, configuration and any required data files included in the Work.
- e. "Publisher" means the provider of the website, magazine, CD-ROM, DVD or other medium from or by which the Work is obtained by You.
- f. "Source Code" refers to the collection of source code and configuration files used to create the Executable Files.



- g. "Standard Version" refers to such a Work if it has not been modified, or has been modified in accordance with the consent of the Author, such consent being in the full discretion of the Author.
- h. "Work" refers to the collection of files distributed by the Publisher, including the Source Code, Executable Files, binaries, data files, documentation, whitepapers and the Articles.
- i. "You" is you, an individual or entity wishing to use the Work and exercise your rights under this License.
2. Fair Use/Fair Use Rights. Nothing in this License is intended to reduce, limit, or restrict any rights arising from fair use, fair dealing, first sale or other limitations on the exclusive rights of the copyright owner under copyright law or other applicable laws.
3. License Grant. Subject to the terms and conditions of this License, the Author hereby grants You a worldwide, royalty-free, non-exclusive, perpetual (for the duration of the applicable copyright) license to exercise the rights in the Work as stated below:
- You may use the standard version of the Source Code or Executable Files in Your own applications.
 - You may apply bug fixes, portability fixes and other modifications obtained from the Public Domain or from the Author. A Work modified in such a way shall still be considered the standard version and will be subject to this License.
 - You may otherwise modify Your copy of this Work (excluding the Articles) in any way to create a Derivative Work, provided that You insert a prominent notice in each changed file stating how, when and where You changed that file.
 - You may distribute the standard version of the Executable Files and Source Code or Derivative Work in aggregate with other (possibly commercial) programs as part of a larger (possibly commercial) software distribution.
- e. The Articles discussing the Work published in any form by the author may not be distributed or republished without the Author's consent. The author retains copyright to any such Articles. You may use the Executable Files and Source Code pursuant to this License but you may not repost or republish or otherwise distribute or make available the Articles, without the prior written consent of the Author.
- Any subroutines or modules supplied by You and linked into the Source Code or Executable Files this Work shall not be considered part of this Work and will not be subject to the terms of this License.
4. Patent License. Subject to the terms and conditions of this License, each Author hereby grants to You a perpetual, worldwide, non-exclusive, no-charge, royalty-free, irrevocable (except as stated in this section) patent license to make, have made, use, import, and otherwise transfer the Work.
5. Restrictions. The license granted in Section 3 above is expressly made subject to and limited by the following restrictions:
- You agree not to remove any of the original copyright, patent, trademark, and attribution notices and associated disclaimers that may appear in the Source Code or Executable Files.
 - You agree not to advertise or in any way imply that this Work is a product of Your own.
 - The name of the Author may not be used to endorse or promote products derived from the Work without the prior written consent of the Author.
 - You agree not to sell, lease, or rent any part of the Work. This does not restrict you from including the Work or any part of the Work inside a larger software distribution that itself is being sold. The Work by itself, though, cannot be sold, leased or rented.
- e. You may distribute the Executable Files and Source Code only under the terms of this License, and You must include a copy of, or the Uniform Resource Identifier for, this License with every copy of the Executable Files or Source Code You distribute and ensure that anyone receiving such Executable Files and Source Code agrees that the terms of this License apply to such Executable Files and/or Source Code. You may not offer or impose any terms on the Work that alter or restrict the terms of this License or the recipients' exercise of the rights granted hereunder. You may not sublicense the Work. You must keep intact all notices that refer to this License and to the disclaimer of warranties. You may not distribute the Executable Files or Source Code with any technological measures that control access or use of the Work in a manner inconsistent with the terms of this License.
- f. You agree not to use the Work for illegal, immoral or improper purposes, or on pages containing illegal, immoral or improper material. The Work is subject to applicable export laws. You agree to comply with all such laws and regulations that may apply to the Work after Your receipt of the Work.



6. Representations, Warranties and Disclaimer. THIS WORK IS PROVIDED "AS IS", "WHERE IS" AND "AS AVAILABLE", WITHOUT ANY EXPRESS OR IMPLIED WARRANTIES OR CONDITIONS OR GUARANTEES. YOU, THE USER, ASSUME ALL RISK IN ITS USE, INCLUDING COPYRIGHT INFRINGEMENT, PATENT INFRINGEMENT, SUITABILITY, ETC. AUTHOR EXPRESSLY DISCLAIMS ALL EXPRESS, IMPLIED OR STATUTORY WARRANTIES OR CONDITIONS, INCLUDING WITHOUT LIMITATION, WARRANTIES OR CONDITIONS OF MERCHANTABILITY, MERCHANTABLE QUALITY OR FITNESS FOR A PARTICULAR PURPOSE, OR ANY WARRANTY OF TITLE OR NON-INFRINGEMENT, OR THAT THE WORK (OR ANY PORTION THEREOF) IS CORRECT, USEFUL, BUG-FREE OR FREE OF VIRUSES. YOU MUST PASS THIS DISCLAIMER ON WHENEVER YOU DISTRIBUTE THE WORK OR DERIVATIVE WORKS.
7. Indemnity. You agree to defend, indemnify and hold harmless the Author and the Publisher from and against any claims, suits, losses, damages, liabilities, costs, and expenses (including reasonable legal or attorneys' fees) resulting from or relating to any use of the Work by You.
8. Limitation on Liability. EXCEPT TO THE EXTENT REQUIRED BY APPLICABLE LAW, IN NO EVENT WILL THE AUTHOR OR THE PUBLISHER BE LIABLE TO YOU ON ANY LEGAL THEORY FOR ANY SPECIAL, INCIDENTAL, CONSEQUENTIAL, PUNITIVE OR EXEMPLARY DAMAGES ARISING OUT OF THIS LICENSE OR THE USE OF THE WORK OR OTHERWISE, EVEN IF THE AUTHOR OR THE PUBLISHER HAS BEEN ADVISED OF THE POSSIBILITY OF SUCH DAMAGES.
9. Termination.
- This License and the rights granted hereunder will terminate automatically upon any breach by You of any term of this License. Individuals or entities who have received Derivative Works from You under this License, however, will not have their licenses terminated provided such individuals or entities remain in full compliance with those licenses. Sections 1, 2, 6, 7, 8, 9, 10 and 11 will survive any termination of this License.
 - If You bring a copyright, trademark, patent or any other infringement claim against any contributor over infringements You claim are made by the Work, your License from such contributor to the Work ends automatically.
 - Subject to the above terms and conditions, this License is perpetual (for the duration of the applicable copyright in the Work). Notwithstanding the above, the Author reserves the right to release the Work under different license terms or to stop distributing the Work at any time; provided, however that any such election will not serve to withdraw this License (or any other license that has been, or is required to be, granted under the terms of this License), and this License will continue in full force and effect unless terminated as stated above.
10. Publisher. The parties hereby confirm that the Publisher shall not, under any circumstances, be responsible for and shall not have any liability in respect of the subject matter of this License. The Publisher makes no warranty whatsoever in connection with the Work and shall not be liable to You or any party on any legal theory for any damages whatsoever, including without limitation any general, special, incidental or consequential damages arising in connection to this license. The Publisher reserves the right to cease making the Work available to You at any time without notice
11. Miscellaneous
- This License shall be governed by the laws of the location of the head office of the Author or if the Author is an individual, the laws of location of the principal place of residence of the Author.
 - If any provision of this License is invalid or unenforceable under applicable law, it shall not affect the validity or enforceability of the remainder of the terms of this License, and without further action by the parties to this License, such provision shall be reformed to the minimum extent necessary to make such provision valid and enforceable.
 - No term or provision of this License shall be deemed waived and no breach consented to unless such waiver or consent shall be in writing and signed by the party to be charged with such waiver or consent.
 - This License constitutes the entire agreement between the parties with respect to the Work licensed herein. There are no understandings, agreements or representations with respect to the Work not specified herein. The Author shall not be bound by any additional provisions that may appear in any communication from You. This License may not be modified without the mutual written agreement of the Author and You.



<http://www.xiph.org/ogg/>

Copyright (c) 2002, Xiph.org Foundation

Redistribution and use in source and binary forms, with or without modification, are permitted provided that the following conditions are met:

- Redistributions of source code must retain the above copyright notice, this list of conditions and the following disclaimer.



- Redistributions in binary form must reproduce the above copyright notice, this list of conditions and the following disclaimer in the documentation and/or other materials provided with the distribution.
- Neither the name of the Xiph.org Foundation nor the names of its contributors may be used to endorse or promote products derived from this software without specific prior written permission.

THIS SOFTWARE IS PROVIDED BY THE COPYRIGHT HOLDERS AND CONTRIBUTORS "AS IS" AND ANY EXPRESS OR IMPLIED WARRANTIES, INCLUDING, BUT NOT LIMITED TO, THE IMPLIED WARRANTIES OF MERCHANTABILITY AND FITNESS FOR A PARTICULAR PURPOSE ARE DISCLAIMED. IN NO EVENT SHALL THE FOUNDATION OR CONTRIBUTORS BE LIABLE FOR ANY DIRECT, INDIRECT, INCIDENTAL, SPECIAL, EXEMPLARY, OR CONSEQUENTIAL DAMAGES (INCLUDING, BUT NOT LIMITED TO, PROCUREMENT OF SUBSTITUTE GOODS OR SERVICES; LOSS OF USE, DATA, OR PROFITS; OR BUSINESS INTERRUPTION) HOWEVER CAUSED AND ON ANY THEORY OF LIABILITY, WHETHER IN CONTRACT, STRICT LIABILITY, OR TORT (INCLUDING NEGLIGENCE OR OTHERWISE) ARISING IN ANY WAY OUT OF THE USE OF THIS SOFTWARE, EVEN IF ADVISED OF THE POSSIBILITY OF SUCH DAMAGE.

libvorbis

<http://www.xiph.org/vorbis/>

Copyright (c) 2002-2004 Xiph.org Foundation

Redistribution and use in source and binary forms, with or without modification, are permitted provided that the following conditions are met:

- Redistributions of source code must retain the above copyright notice, this list of conditions and the following disclaimer.
- Redistributions in binary form must reproduce the above copyright notice, this list of conditions and the following disclaimer in the documentation and/or other materials provided with the distribution.
- Neither the name of the Xiph.org Foundation nor the names of its contributors may be used to endorse or promote products derived from this software without specific prior written permission.

THIS SOFTWARE IS PROVIDED BY THE COPYRIGHT HOLDERS AND CONTRIBUTORS "AS IS" AND ANY EXPRESS OR IMPLIED WARRANTIES, INCLUDING, BUT NOT LIMITED TO, THE IMPLIED WARRANTIES OF MERCHANTABILITY AND FITNESS FOR A PARTICULAR PURPOSE ARE DISCLAIMED. IN NO EVENT SHALL THE FOUNDATION OR CONTRIBUTORS BE LIABLE FOR ANY DIRECT, INDIRECT, INCIDENTAL, SPECIAL, EXEMPLARY, OR CONSEQUENTIAL DAMAGES (INCLUDING, BUT NOT LIMITED TO, PROCUREMENT OF SUBSTITUTE GOODS OR SERVICES; LOSS OF USE, DATA, OR PROFITS; OR BUSINESS INTERRUPTION) HOWEVER CAUSED AND ON ANY THEORY OF LIABILITY, WHETHER IN CONTRACT, STRICT LIABILITY, OR TORT (INCLUDING NEGLIGENCE OR OTHERWISE) ARISING IN ANY WAY OUT OF THE USE OF THIS SOFTWARE, EVEN IF ADVISED OF THE POSSIBILITY OF SUCH DAMAGE.

Tremolo

<http://wss.co.uk/pinknoise/tremolo>

Copyright (C) 2002-2009 Xiph.org Foundation Changes
Copyright (C) 2009-2010 Robin Watts for Pinknoise Productions Ltd

Redistribution and use in source and binary forms, with or without modification, are permitted provided that the following conditions are met:

- Redistributions of source code must retain the above copyright notice, this list of conditions and the following disclaimer.
- Redistributions in binary form must reproduce the above copyright notice, this list of conditions and the following disclaimer in the documentation and/or other materials provided with the distribution.
- Neither the name of the Xiph.org Foundation nor the names of its contributors may be used to endorse or promote products derived from this software without specific prior written permission.

THIS SOFTWARE IS PROVIDED BY THE COPYRIGHT HOLDERS AND CONTRIBUTORS "AS IS" AND ANY EXPRESS OR IMPLIED WARRANTIES, INCLUDING, BUT NOT LIMITED TO, THE IMPLIED WARRANTIES OF MERCHANTABILITY AND FITNESS FOR A PARTICULAR PURPOSE ARE DISCLAIMED. IN NO EVENT SHALL THE FOUNDATION OR CONTRIBUTORS BE LIABLE FOR ANY DIRECT, INDIRECT, INCIDENTAL, SPECIAL, EXEMPLARY, OR CONSEQUENTIAL DAMAGES (INCLUDING, BUT NOT LIMITED TO, PROCUREMENT OF SUBSTITUTE GOODS OR SERVICES; LOSS OF USE, DATA, OR PROFITS; OR BUSINESS INTERRUPTION) HOWEVER CAUSED AND ON ANY THEORY OF LIABILITY, WHETHER IN CONTRACT, STRICT LIABILITY, OR TORT (INCLUDING NEGLIGENCE OR OTHERWISE) ARISING IN ANY WAY OUT OF THE USE OF THIS SOFTWARE, EVEN IF ADVISED OF THE POSSIBILITY OF SUCH DAMAGE.



❏ Tremor

<http://wiki.xiph.org/index.php/Tremor>

Copyright (c) 2002, Xiph.org Foundation

Redistribution and use in source and binary forms, with or without modification, are permitted provided that the following conditions are met:

- Redistributions of source code must retain the above copyright notice, this list of conditions and the following disclaimer.
- Redistributions in binary form must reproduce the above copyright notice, this list of conditions and the following disclaimer in the documentation and/or other materials provided with the distribution.
- Neither the name of the Xiph.org Foundation nor the names of its contributors may be used to endorse or promote products derived from this software without specific prior written permission.

THIS SOFTWARE IS PROVIDED BY THE COPYRIGHT HOLDERS AND CONTRIBUTORS "AS IS" AND ANY EXPRESS OR IMPLIED WARRANTIES, INCLUDING, BUT NOT LIMITED TO, THE IMPLIED WARRANTIES OF MERCHANTABILITY AND FITNESS FOR A PARTICULAR PURPOSE ARE DISCLAIMED. IN NO EVENT SHALL THE FOUNDATION OR CONTRIBUTORS BE LIABLE FOR ANY DIRECT, INDIRECT, INCIDENTAL, SPECIAL, EXEMPLARY, OR CONSEQUENTIAL DAMAGES (INCLUDING, BUT NOT LIMITED TO, PROCUREMENT OF SUBSTITUTE GOODS OR SERVICES; LOSS OF USE, DATA, OR PROFITS; OR BUSINESS INTERRUPTION) HOWEVER CAUSED AND ON ANY THEORY OF LIABILITY, WHETHER IN CONTRACT, STRICT LIABILITY, OR TORT (INCLUDING NEGLIGENCE OR OTHERWISE) ARISING IN ANY WAY OUT OF THE USE OF THIS SOFTWARE, EVEN IF ADVISED OF THE POSSIBILITY OF SUCH DAMAGE.

❏ Mersenne Twister

<http://www.math.sci.hiroshima-u.ac.jp/~m-mat/MT/MT2002/CODES/mt19937ar.c>

Copyright (C) 1997 - 2002, Makoto Matsumoto and Takuji Nishimura,
All rights reserved.

Redistribution and use in source and binary forms, with or without modification, are permitted provided that the following conditions are met:

1. Redistributions of source code must retain the above copyright notice, this list of conditions and the following disclaimer.

2. Redistributions in binary form must reproduce the above copyright notice, this list of conditions and the following disclaimer in the documentation and/or other materials provided with the distribution.
3. The names of its contributors may not be used to endorse or promote products derived from this software without specific prior written permission.

THIS SOFTWARE IS PROVIDED BY THE COPYRIGHT HOLDERS AND CONTRIBUTORS "AS IS" AND ANY EXPRESS OR IMPLIED WARRANTIES, INCLUDING, BUT NOT LIMITED TO, THE IMPLIED WARRANTIES OF MERCHANTABILITY AND FITNESS FOR A PARTICULAR PURPOSE ARE DISCLAIMED. IN NO EVENT SHALL THE COPYRIGHT OWNER OR CONTRIBUTORS BE LIABLE FOR ANY DIRECT, INDIRECT, INCIDENTAL, SPECIAL, EXEMPLARY, OR CONSEQUENTIAL DAMAGES (INCLUDING, BUT NOT LIMITED TO, PROCUREMENT OF SUBSTITUTE GOODS OR SERVICES; LOSS OF USE, DATA, OR PROFITS; OR BUSINESS INTERRUPTION) HOWEVER CAUSED AND ON ANY THEORY OF LIABILITY, WHETHER IN CONTRACT, STRICT LIABILITY, OR TORT (INCLUDING NEGLIGENCE OR OTHERWISE) ARISING IN ANY WAY OUT OF THE USE OF THIS SOFTWARE, EVEN IF ADVISED OF THE POSSIBILITY OF SUCH DAMAGE.



**zlib**

<http://www.zlib.net/>

zlib.h – interface of the ‘zlib’ general purpose compression library version 1.2.3, July 18th, 2005

Copyright (C) 1995-2004 Jean-loup Gailly and Mark Adler

This software is provided ‘as-is’, without any express or implied warranty. In no event will the authors be held liable for any damages arising from the use of this software.

Permission is granted to anyone to use this software for any purpose, including commercial applications, and to alter it and redistribute it freely, subject to the following restrictions:

1. The origin of this software must not be misrepresented; you must not claim that you wrote the original software. If you use this software in a product, an acknowledgment in the product documentation would be appreciated but is not required.
2. Altered source versions must be plainly marked as such, and must not be misrepresented as being the original software.
3. This notice may not be removed or altered from any source distribution.

Jean-loup Gailly jloup@gzip.org, Mark Adler madler@alumni.caltech.edu

**cURL**

<http://curl.haxx.se>

COPYRIGHT AND PERMISSION NOTICE

Copyright (c) 1996 - 2011, Daniel Stenberg, <daniel@haxx.se>.

All rights reserved.

Permission to use, copy, modify, and distribute this software for any purpose with or without fee is hereby granted, provided that the above copyright notice and this permission notice appear in all copies.

THE SOFTWARE IS PROVIDED “AS IS”, WITHOUT WARRANTY OF ANY KIND, EXPRESS OR IMPLIED, INCLUDING BUT NOT LIMITED TO THE WARRANTIES OF MERCHANTABILITY, FITNESS FOR A PARTICULAR PURPOSE AND NONINFRINGEMENT OF THIRD PARTY RIGHTS. IN NO EVENT SHALL THE AUTHORS OR COPYRIGHT HOLDERS BE LIABLE FOR ANY CLAIM, DAMAGES OR OTHER LIABILITY, WHETHER IN AN ACTION OF CONTRACT, TORT OR OTHERWISE, ARISING FROM, OUT OF OR IN CONNECTION WITH THE SOFTWARE OR THE USE OR OTHER DEALINGS IN THE SOFTWARE.

Except as contained in this notice, the name of a copyright holder shall not be used in advertising or otherwise to promote the sale, use or other dealings in this Software without prior written authorization of the copyright holder.

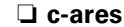
**c-ares**

<http://c-ares.haxx.se>

Copyright 1998 by the Massachusetts Institute of Technology.

Permission to use, copy, modify, and distribute this software and its documentation for any purpose and without fee is hereby granted, provided that the above copyright notice appear in all copies and that both that copyright notice and this permission notice appear in supporting documentation, and that the name of M.I.T. not be used in advertising or publicity pertaining to distribution of the software without specific, written prior permission. M.I.T. makes no representations about the suitability of this software for any purpose. It is provided “as is” without express or implied warranty.



■ License Information for the Software Used in the Unit

About GPL (GNU-General Public License), LGPL (GNU Lesser General Public License) License

This product uses GPL/LGPL software and software made by other companies.

After you purchase this product, you may procure, modify or distribute the source code of the GPL/LGPL software that is used in the product.

Marantz provides the source code based on the GPL and LGPL licenses at the actual cost upon your request to our customer service center. However, note that we make no guarantees concerning the source code. Please also understand that we do not offer support for the contents of the source code.



■ Dimensions

Unit : in. (mm)

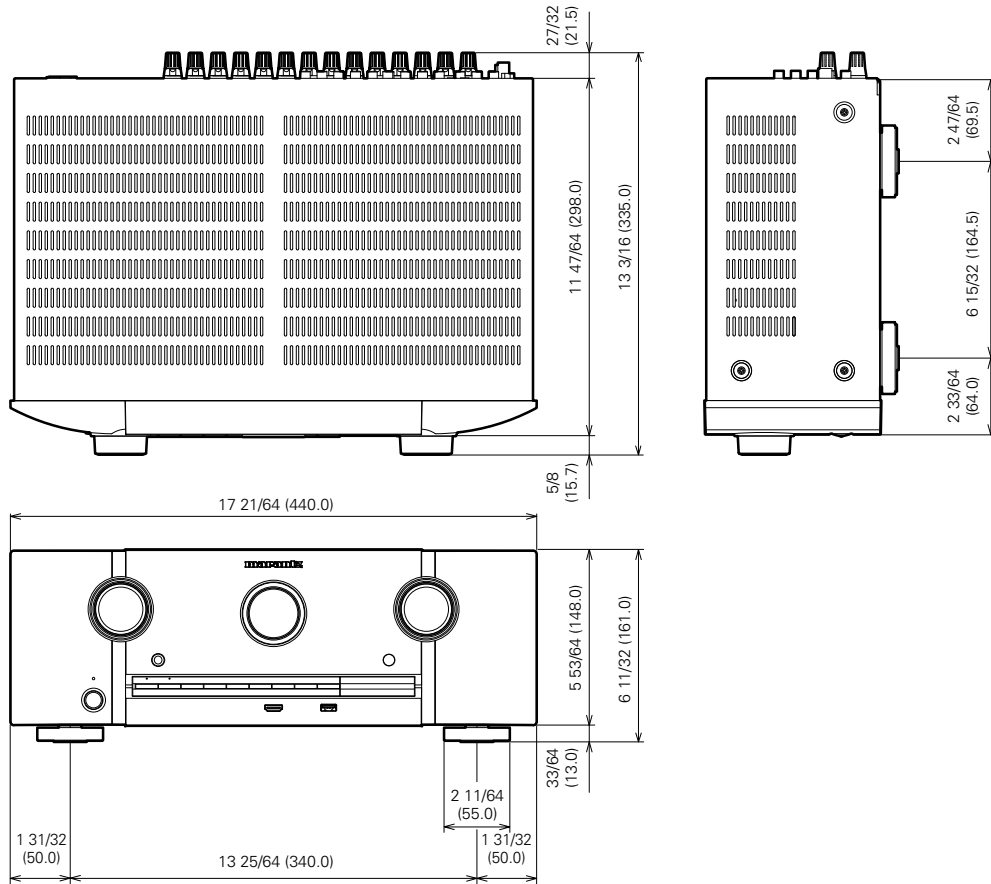

■ Weight : 22 lbs 4 oz (10.1 kg)



www.marantz.com

You can find your nearest authorized distributor or dealer on our website.

marantz[®] is a registered trademark.