

**marantz**<sup>®</sup>

AV Surround Receiver

**NR1504**

Owner's Manual

## SAFETY PRECAUTIONS



**CAUTION**  
**RISK OF ELECTRIC SHOCK**  
**DO NOT OPEN**



**CAUTION:**  
**TO REDUCE THE RISK OF ELECTRIC SHOCK, DO NOT REMOVE COVER (OR BACK). NO USER-SERVICEABLE PARTS INSIDE. REFER SERVICING TO QUALIFIED SERVICE PERSONNEL.**

The lightning flash with arrowhead symbol, within an equilateral triangle, is intended to alert the user to the presence of uninsulated "dangerous voltage" within the product's enclosure that may be of sufficient magnitude to constitute a risk of electric shock to persons.

The exclamation point within an equilateral triangle is intended to alert the user to the presence of important operating and maintenance (servicing) instructions in the literature accompanying the appliance.

**WARNING:**  
**TO REDUCE THE RISK OF FIRE OR ELECTRIC SHOCK, DO NOT EXPOSE THIS APPLIANCE TO RAIN OR MOISTURE.**



Hot surface mark

**CAUTION:**  
**HOT SURFACE. DO NOT TOUCH.**

The top surface over the internal heat sink may become hot when operating this product continuously. Do not touch hot areas, especially around the "Hot surface mark" and the top panel.

## IMPORTANT SAFETY INSTRUCTIONS

1. Read these instructions.
2. Keep these instructions.
3. Heed all warnings.
4. Follow all instructions.
5. Do not use this apparatus near water.
6. Clean only with dry cloth.
7. Do not block any ventilation openings. Install in accordance with the manufacturer's instructions.
8. Do not install near any heat sources such as radiators, heat registers, stoves, or other apparatus (including amplifiers) that produce heat.
9. Do not defeat the safety purpose of the polarized or grounding-type plug. A polarized plug has two blades with one wider than the other. A grounding type plug has two blades and a third grounding prong. The wide blade or the third prong are provided for your safety. If the provided plug does not fit into your outlet, consult an electrician for replacement of the obsolete outlet.
10. Protect the power cord from being walked on or pinched particularly at plugs, convenience receptacles, and the point where they exit from the apparatus.
11. Only use attachments/accessories specified by the manufacturer.
12. Use only with the cart, stand, tripod, bracket, or table specified by the manufacturer, or sold with the apparatus. When a cart is used, use caution when moving the cart/apparatus combination to avoid injury from tip-over.
13. Unplug this apparatus during lightning storms or when unused for long periods of time.
14. Refer all servicing to qualified service personnel. Servicing is required when the apparatus has been damaged in any way, such as power-supply cord or plug is damaged, liquid has been spilled or objects have fallen into the apparatus, the apparatus has been exposed to rain or moisture, does not operate normally, or has been dropped.
15. Batteries shall not be exposed to excessive heat such as sunshine, fire or the like.



### CAUTION:

To completely disconnect this product from the mains, disconnect the plug from the wall socket outlet. The mains plug is used to completely interrupt the power supply to the unit and must be within easy access by the user.

## FCC INFORMATION (For US customers)

### 1. COMPLIANCE INFORMATION

Product Name: AV Surround Receiver  
Model Number: NR1504  
This product complies with Part 15 of the FCC Rules. Operation is subject to the following two conditions: (1) this product may not cause harmful interference, and (2) this product must accept any interference received, including interference that may cause undesired operation.  
Marantz America, LLC.  
(a D&M Holdings Company)  
100 Corporate Drive,  
Mahwah, NJ, 07430, U.S.A.  
Tel. 201-762-6500

### 2. IMPORTANT NOTICE: DO NOT MODIFY THIS PRODUCT

This product, when installed as indicated in the instructions contained in this manual, meets FCC requirements. Modification not expressly approved by Marantz may void your authority, granted by the FCC, to use the product.

### 3. IMPORTANT

When connecting this product to network hub or router, use only a shielded STP or ScTP LAN cable which is available at retailer. Follow all installation instructions. Failure to follow instructions could void your authority, granted by the FCC, to use the product.

### 4. NOTE

This product has been tested and found to comply with the limits for a Class B digital device, pursuant to Part 15 of the FCC Rules. These limits are designed to provide reasonable protection against harmful interference in a residential installation.

This product generates, uses and can radiate radio frequency energy and, if not installed and used in accordance with the instructions, may cause harmful interference to radio communications. However, there is no guarantee that interference will not occur in a particular installation. If this product does cause harmful interference to radio or television reception, which can be determined by turning the product OFF and ON, the user is encouraged to try to correct the interference by one or more of the following measures:

- Reorient or relocate the receiving antenna.
- Increase the separation between the equipment and receiver.
- Connect the product into an outlet on a circuit different from that to which the receiver is connected.
- Consult the local retailer authorized to distribute this type of product or an experienced radio/TV technician for help.

### For Canadian customers:

This Class B digital apparatus complies with Canadian ICES-003.

## NOTES ON USE

### WARNINGS

- Avoid high temperatures.  
Allow for sufficient heat dispersion when installed in a rack.
- Handle the power cord carefully.  
Hold the plug when unplugging the cord.
- Keep the unit free from moisture, water, and dust.
- Unplug the power cord when not using the unit for long periods of time.
- Do not obstruct the ventilation holes.
- Do not let foreign objects into the unit.
- Do not let insecticides, benzene, and thinner come in contact with the unit.
- Never disassemble or modify the unit in any way.
- Ventilation should not be impeded by covering the ventilation openings with items, such as newspapers, tablecloths or curtains.
- Naked flame sources such as lighted candles should not be placed on the unit.
- Observe and follow local regulations regarding battery disposal.
- Do not expose the unit to dripping or splashing fluids.
- Do not place objects filled with liquids, such as vases, on the unit.
- Do not handle the mains cord with wet hands.
- When the switch is in the OFF (STANDBY) position, the equipment is not completely switched off from MAINS.
- The equipment shall be installed near the power supply so that the power supply is easily accessible.
- Do not keep the battery in a place exposed to direct sunlight or in places with extremely high temperatures, such as near a heater.

## CAUTIONS ON INSTALLATION

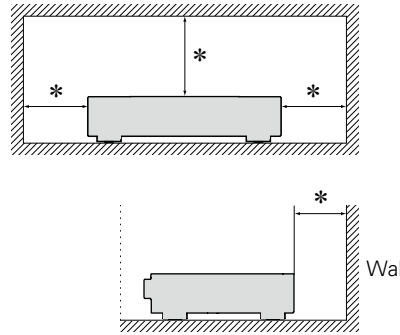

**\* For proper heat dispersal, do not install this unit in a confined space, such as a bookcase or similar enclosure.**

- More than 12 in. (0.3 m) is recommended.

# Getting started

Thank you for purchasing this Marantz product. To ensure proper operation, please read this owner's manual carefully before using the product. After reading this manual, be sure to keep it for future reference.

## Contents

<b>Getting started</b> .....	<a href="#">1</a>
Accessories .....	<a href="#">2</a>
Features .....	<a href="#">2</a>
Cautions on handling .....	<a href="#">3</a>

## Basic instructions .....

[4](#)

<b>Connections</b> .....	<a href="#">5</a>
Important information .....	<a href="#">5</a>
Connecting HDMI devices .....	<a href="#">7</a>
Connecting other devices .....	<a href="#">12</a>
Connecting to a home network (LAN) .....	<a href="#">21</a>
Connecting the power cord .....	<a href="#">22</a>
<b>Setup</b> .....	<a href="#">23</a>
Set up speakers (Audyssey® Setup) .....	<a href="#">23</a>
Making the network settings (Network) .....	<a href="#">29</a>
<b>Playback (Basic operation)</b> .....	<a href="#">30</a>
Important information .....	<a href="#">30</a>
Playing a Blu-ray Disc player/DVD player .....	<a href="#">31</a>
Playing a CD player .....	<a href="#">31</a>
Playing an iPod .....	<a href="#">32</a>
Playing a USB memory device .....	<a href="#">35</a>
Listening to FM/AM broadcasts .....	<a href="#">38</a>
<b>Network content</b> .....	<a href="#">47</a>
Listening to Internet Radio .....	<a href="#">47</a>
Playing back files stored on a PC and NAS .....	<a href="#">50</a>
Using online services .....	<a href="#">54</a>
Convenient functions .....	<a href="#">65</a>
AirPlay function .....	<a href="#">70</a>
<b>Selecting a listening mode (Sound Mode)</b> .....	<a href="#">72</a>
Selecting a listening mode .....	<a href="#">72</a>

## Advanced instructions .....

[77](#)

<b>Installation/connection/setup of speakers (Advanced)</b> .....	<a href="#">78</a>
Speaker installation .....	<a href="#">78</a>
Speaker connection .....	<a href="#">79</a>
<b>Connections (Advanced connection)</b> .....	<a href="#">82</a>
Connecting the REMOTE CONTROL connectors .....	<a href="#">82</a>
<b>Playback (Advanced operation)</b> .....	<a href="#">83</a>
HDMI control function .....	<a href="#">83</a>
Sleep timer function .....	<a href="#">84</a>
Web control function .....	<a href="#">85</a>
Dual backup memory function .....	<a href="#">86</a>
Panel lock function .....	<a href="#">87</a>
Remote lock function .....	<a href="#">88</a>
Various memory functions .....	<a href="#">88</a>
<b>How to make detailed settings</b> .....	<a href="#">89</a>
Menu map .....	<a href="#">89</a>
Examples of menu screen displays .....	<a href="#">90</a>
Examples of menu and front display .....	<a href="#">91</a>
Inputting characters .....	<a href="#">92</a>
Audio .....	<a href="#">93</a>
Video .....	<a href="#">99</a>
Inputs .....	<a href="#">102</a>
Speakers .....	<a href="#">106</a>
Network .....	<a href="#">110</a>
General .....	<a href="#">114</a>

## Information .....

[119](#)

<b>Part names and functions</b> .....	<a href="#">120</a>
Front panel .....	<a href="#">120</a>
Display .....	<a href="#">121</a>
Rear panel .....	<a href="#">122</a>
Remote control unit .....	<a href="#">123</a>
<b>Other information</b> .....	<a href="#">125</a>
Trademark information .....	<a href="#">125</a>
Surround .....	<a href="#">126</a>
Relationship between video signals and monitor output .....	<a href="#">129</a>
Explanation of terms .....	<a href="#">130</a>
<b>Troubleshooting</b> .....	<a href="#">132</a>
Resetting the microprocessor .....	<a href="#">136</a>
<b>Specifications</b> .....	<a href="#">136</a>

## Accessories

Check that the following parts are supplied with the product.

① Getting Started .....	1
② CD-ROM (Owner's Manual) .....	1
③ Safety Instructions .....	1
④ Warranty card (for USA) .....	1
⑤ Warranty card (for CANADA) .....	1
⑥ Power cord .....	1
⑦ Remote control unit (RC020SR) .....	1
⑧ R03/AAA batteries .....	2
⑨ AM loop antenna .....	1
⑩ FM indoor antenna .....	1
⑪ Setup and measurement microphone (ACM1HB) .....	1
⑫ Cable label .....	1

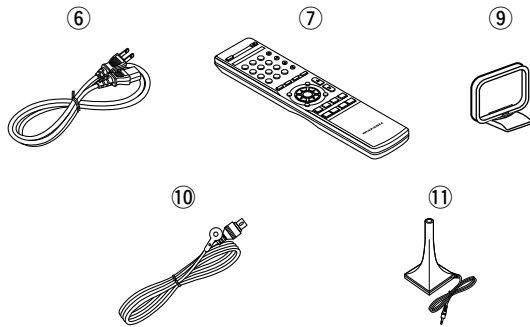

## Features

### With discrete circuit technology, the power amplifier provides identical quality for all 5 channels (50 Watts x 5 channels)

For optimum realism and stunning dynamic range, the power amplifier section features discrete power devices (not integrated circuitry).

By using high current, high power discrete power devices, the amplifier is able to easily drive high quality speakers.

### Supports Internet Radio, music, and photograph streaming

#### Supports AirPlay® (👉 page 70)

You can enjoy a wide variety of content, including listening to Internet Radio, playing audio files stored on your PC, and displaying photographs stored on your PC on our television.

This unit also supports Apple AirPlay which lets you stream your music library from an iPhone®, iPad®, iPod touch® or iTunes®.

### Compatible with “Marantz Remote App” for performing basic operations of the unit with an iPad, iPhone\* or Android smartphone

“Marantz Remote App” is application software that allows you to perform basic operations with an iPad, iPhone, Android smartphone or Android tablet such as turning the unit ON/OFF, controlling the volume, and switching the source.

\* Download the appropriate “Marantz Remote App” for iOS and Android devices. This unit needs to be connected to your LAN and the iPhone/iPod touch or other device needs to be connected to the same network by Wi-Fi (wireless LAN).

### “Setup Assistant” provides easy-to-follow setup instructions

First select the language when prompted. Then simply follow the instructions displayed on the TV screen to set up the speakers, network, etc.

### New easy setup

New, easy to connect speaker connectors with horizontal layout and new push-type speaker terminals.

### Easy to use Graphical User Interface

This unit is equipped with an easy to see Graphical User Interface that uses menu displays and features colorful icons and easy to understand controls for maximum ease of use.

### HDMI connections enable quick connection to various digital AV devices (6 inputs, 1 output)

The unit is equipped with 6 HDMI input connectors for connecting devices with HDMI connectors, such as a Blu-ray Disc player, game console, HD video camcorder, HDTVs, etc.

### Supports HDMI (3D, ARC, Deep Color, “x.v.Color”, Auto Lip Sync) and HDMI control function (👉 page 7)

Advanced HDMI features are supported, including 3D passthrough, Audio Return Channel, Auto Lip Sync, Deep Color and “x.v.Color”, and HDMI CEC control functions.

### Direct play for iPod and iPhone via USB (👉 page 17)

Music data from an iPod or iPhone can be played back if you connect the USB cable supplied with the iPod via the USB port of this unit, and also an iPod can be controlled with the remote control that comes with this unit.

### M-XPort (Marantz-eXtension Port) (👉 page 20)

This unit is equipped with the M-XPort, a Marantz original innovation that provides outstanding expandability. You can connect the Wireless Receiver RX101 (sold separately) to this port.

## Cautions on handling

- **Before turning the power on**

Check once again that all connections are correct and that there are no problems with the connection cables.

- Power is supplied to some of the circuitry even when the unit is set to the standby mode. When going on vacation or leaving home for long periods of time, be sure to unplug the power cord from the power outlet.

- **About condensation**

If there is a major difference in temperature between the inside of the unit and the surroundings, condensation (dew) may form on the operating parts inside the unit, causing the unit not to operate properly.

If this happens, let the unit sit for an hour or two with the power turned off and wait until there is little difference in temperature before using the unit.

- **Cautions on using mobile phones**

Using a mobile phone near this unit may result in noise. If that occurs, move the mobile phone away from this unit when it is in use.

- **Moving the unit**

Turn off the power and unplug the power cord from the power outlet. Next, disconnect the connection cables to other system units before moving the unit.





- **About care**

- Wipe the cabinet and control panel clean with a soft cloth.
- Follow the instructions when using a chemical cleaner.
- Benzene, paint thinner or other organic solvents as well as insecticide may cause material changes and discoloration if brought into contact with the unit, and should therefore not be used.

## Basic instructions

---

Here we explain the connections and basic operation methods for this unit.

- **Connections**  [page 5](#)
- **Setup**  [page 23](#)
- **Playback (Basic operation)**  [page 30](#)
- **Network content**  [page 47](#)
- **Selecting a listening mode (Sound Mode)**  [page 72](#)

For speaker connections, see [page 79](#).

















# Connections

## Important information

Make connections before using this unit.

























To create a home theater that can play back higher quality video and audio by fully utilizing the capabilities of this unit and your video devices, connect this unit to each of your video devices with HDMI cables.

### □ HDMI devices



 TV  <a href="#">page 9</a>	 CBL/SAT  <a href="#">page 10</a>	 DVD  <a href="#">page 10</a>
 Blu-ray  <a href="#">page 10</a>	 GAME  <a href="#">page 10</a>	 MEDIA PLAYER  <a href="#">page 10</a>
 CD  <a href="#">page 10</a>	 AUX  <a href="#">page 10</a>	

If your video device does not support HDMI connections, use the following connection.



### □ Other devices

 TV  <a href="#">page 13</a>	 CBL/SAT  <a href="#">page 14</a>	 DVD  <a href="#">page 15</a>
 Blu-ray  <a href="#">page 15</a>	 MEDIA PLAYER  <a href="#">page 16</a>	 iPod/USB  <a href="#">page 17</a>
 CD  <a href="#">page 18</a>	 TUNER  <a href="#">page 19</a>	 M-XPoort  <a href="#">page 20</a>
 NETWORK  <a href="#">page 21</a>	 SPEAKER  <a href="#">page 79</a>	 AC IN  <a href="#">page 22</a>

This unit can change the source that is assigned to the DIGITAL AUDIO IN, ANALOG AUDIO IN and VIDEO IN connectors.

For details on assigning a source to connectors, see “Changing the source assigned to connectors” ( [page 12](#)). For the setting method, see “Input Assign” ( [page 103](#)).

### NOTE

- The menu screen is only displayed on TV connected to this unit via HDMI. If your TV is connected to this unit via other video output connectors, perform menu operations while seeing the display on this unit.
- Do not plug in the power cord until all connections have been completed. However, when the “Setup Assistant” is running, follow the instructions in the “Setup Assistant” ( [page 7](#)) screen for making connections. (During “Setup Assistant” operation, the input/output connectors do not conduct current.)
- When running the “Setup Assistant” ( [page 7](#)), turn off the power supply of connected devices.
- When making connections, also refer to the operating instructions of the other devices being connected.
- Be sure to connect the left and right channels properly (left with left, right with right).
- Do not bundle power cords together with connection cables. Doing so can result in noise.



## Relationship between video signals and monitor output

This unit is equipped with two types of video input connectors (HDMI and composite video) and two type of video output connectors (HDMI and composite video).

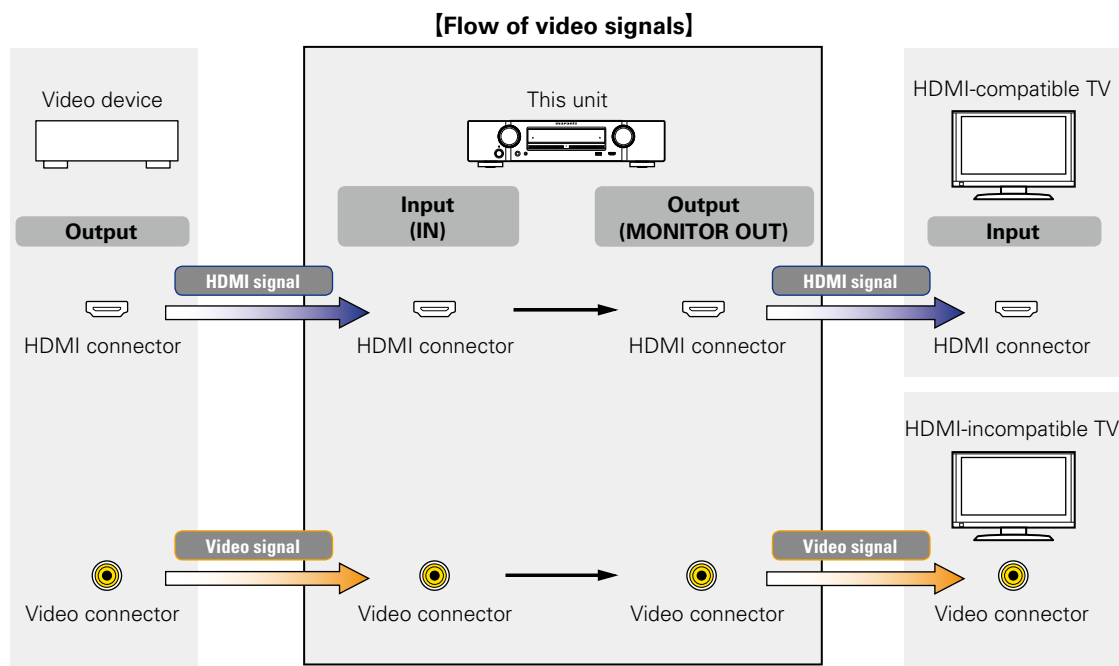

Resolutions of HDMI-compatible TVs can be checked at “Video” – “HDMI Monitor” ([page 116](#)).

### NOTE

- **The menu screen is only displayed on TV connected to this unit via HDMI. If your TV is connected to this unit via other video output connectors, perform menu operations while seeing the display on this unit.**
- HDMI signals are digital audio and digital video. HDMI signals cannot be converted into analog signals ([page 129](#)).
- Analog signals cannot be converted into HDMI signals ([page 129](#)).

## Connecting HDMI devices

You can connect up to seven HDMI-compatible devices (6-inputs/1-output) to the unit.

If the device connected to this unit is equipped with an HDMI connector, it is recommended to use HDMI connections. Connections with an HDMI cable offer the following benefits that can not be achieved with other connection methods.

- **High quality playback by transmitting audio and video via digital signals**

HDMI connections can transmit high definition video and high quality audio formats adopted by Blu-ray disc players (Dolby Digital Plus, Dolby TrueHD, dts-HD, dts-HD Master Audio).

HDMI connections also convey information required for playback between devices. The information is used for copyright protection and TV resolution recognition, the ARC function, the HDMI control function, etc.

- **Transmission of audio and video signals with a single HDMI cable**

Previous connections required multiple audio and video cables, but HDMI connections require only a single HDMI cable to transmit audio and video signals. This allows wires in a home theater system, which tend to be complicated, to be more easily organized.

- **Mutual control through the HDMI control function** (👉 [page 83](#))

This unit and the HDMI device connected via HDMI can be linked to perform operations such as power control, volume control, and input source switching.

- **Other video and audio functions, such as 3D video playback, Content Type, the ARC function, are supported** (👉 [page 11](#)).



- There is more than one version of the HDMI standard. The supported functions and the performance vary according to the version. This unit complies with the HDMI standard that supports the ARC and 3D playback functions. To enjoy these functions, the HDMI device connected to this unit also needs to use the same version of the standard. For the version of the HDMI standard on the device connected to this unit, see the device's manual.
- Some TVs do not support audio input via HDMI connections. For details, see your TV's manual.

❑ **Before connecting this unit to TV via HDMI connections** (👉 [page 8](#))

❑ **Connecting this unit to a TV via HDMI connections** (👉 [page 9](#))

❑ **Connecting this unit to video devices via HDMI connections** (👉 [page 10](#))

❑ **HDMI function** (👉 [page 11](#))

❑ **Settings related to HDMI connections** (👉 [page 11](#))

## Before connecting this unit to TV via HDMI connections

There are 2 methods to connect an HDMI-compatible TV to this unit.  
Use the connection method that suits your TV.

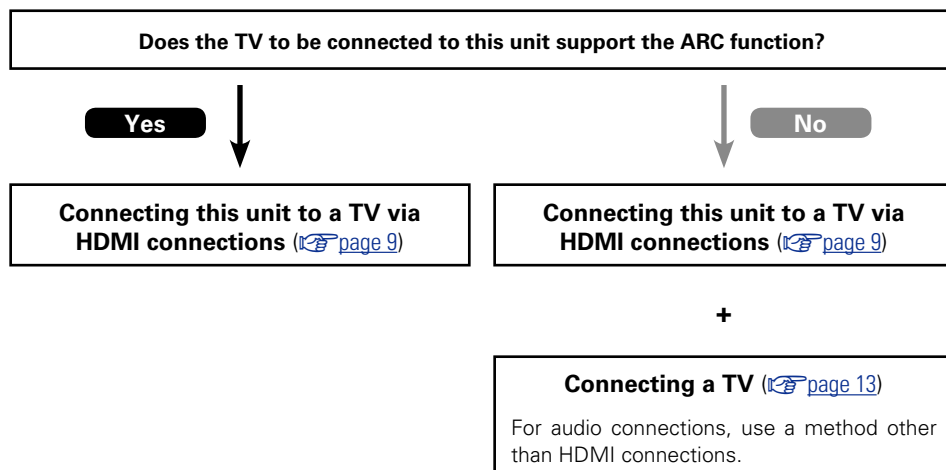

## About ARC (Audio Return Channel) function

This function plays TV audio on this unit by sending the TV audio signal to this unit via the HDMI cable. If a TV without the ARC function is connected via HDMI connections, video signals of the playback device connected to this unit are transmitted to the TV, but this unit can not play back the audio from the TV. If you want to enjoy surround audio for TV program, a separate audio cable connection is required.

In contrast, if a TV with the ARC function is connected via HDMI connections, no audio cable connection is required. Audio signals from the TV can be input to this unit through the HDMI cable between this unit and the TV. This function allows you to enjoy surround playback on this unit for the TV.



When the ARC function is used, connect a device with a "Standard HDMI cable with Ethernet" or "High Speed HDMI cable with Ethernet" for HDMI. Refer to the owner's manual for your TV for details about TV connection and settings.

### [Connection to a TV with the ARC function]

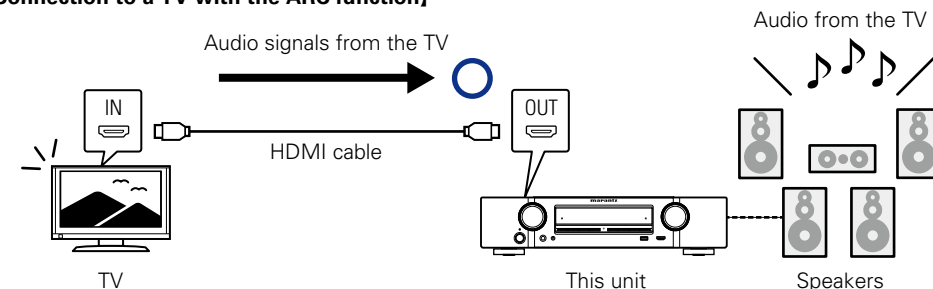

### [Connection to a TV without the ARC function]

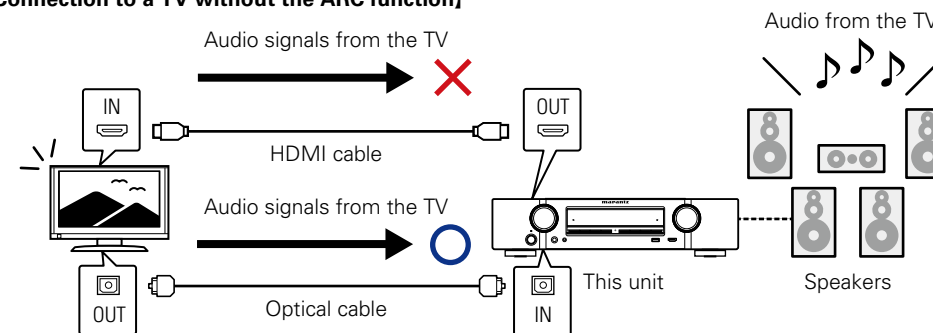

## Connecting this unit to a TV via HDMI connections

### Cables used for connections

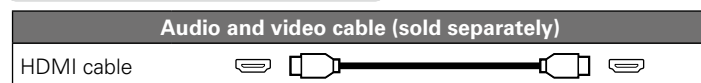

- This interface allows transfer of digital video signals and digital audio signals over a single HDMI cable.

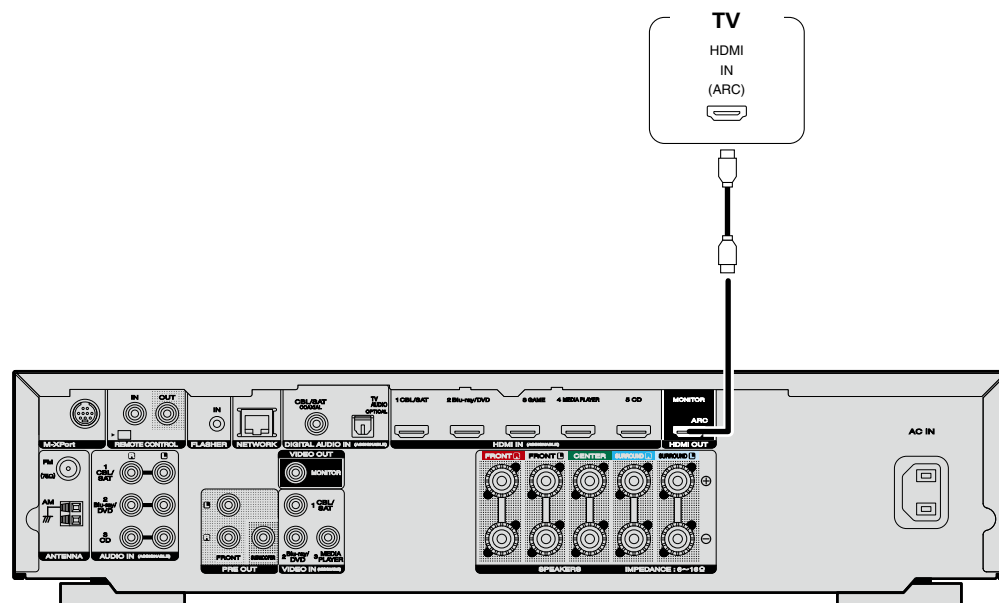

- Video signals are not output if the input video signals do not match the display's resolution. In this case, switch the Blu-ray Disc/DVD player's resolution to a resolution with which the display is compatible.
- When this unit and monitor are connected with an HDMI cable, if the display or monitor is not compatible with HDMI audio signal playback, only the video signals are sent to the display or monitor. Make audio connections ([page 13](#) "Connecting a TV").

### NOTE

- The audio signal from the HDMI output connector (sampling frequency, number of channels, etc.) may be limited by the HDMI audio specifications of the connected device regarding permissible inputs.
- When connecting a TV that does not support the ARC function, an audio cable connection is required in addition to the HDMI cable. In this case, refer to "Connecting a TV" ([page 13](#)) for the connection method.**

For the ARC function, see "About ARC (Audio Return Channel) function" ([page 8](#)).

### Connecting to a device equipped with a DVI-D connector

The DVI-D (Digital Visual Interface) method is also used for video transmission via digital signals. This is developed mainly for computers, and some displays such as projectors are equipped with this interface. To output HDMI video signals to a DVI-D video input compatible device, use an HDMI/DVI conversion cable or adapter.

The DVI-D connector can transmit high quality digital video signals, but copy guard and other issues may hinder normal operations for some device combinations.

### NOTE

- No sound is output when connected to a device equipped with a DVI-D connector. Make audio connections as described in "Connecting a TV" ([page 13](#)).
- Signals cannot be output to DVI-D devices that do not support HDCP.
- Depending on the combination of devices, the video signals may not be output.

### Settings required when using a TV that supports the ARC function

When using a TV that supports the ARC function, make the following settings.

- Set "HDMI Control" ([page 100](#)) to "On".

## Connecting this unit to video devices via HDMI connections

### Cables used for connections

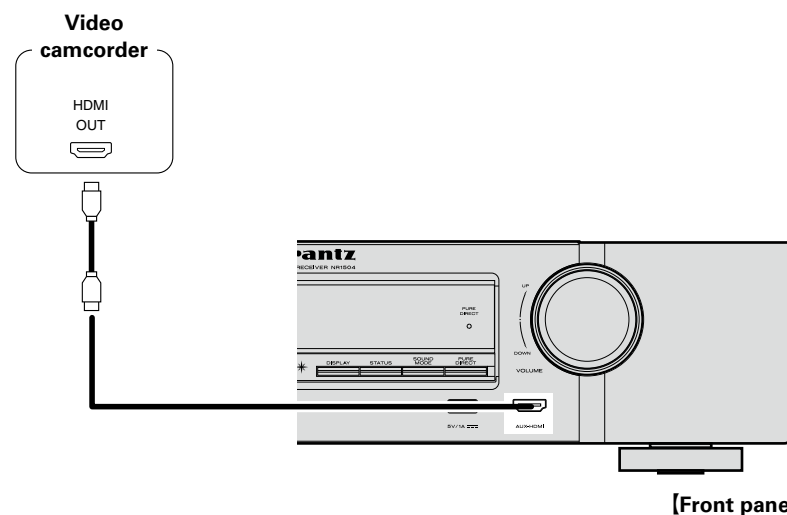
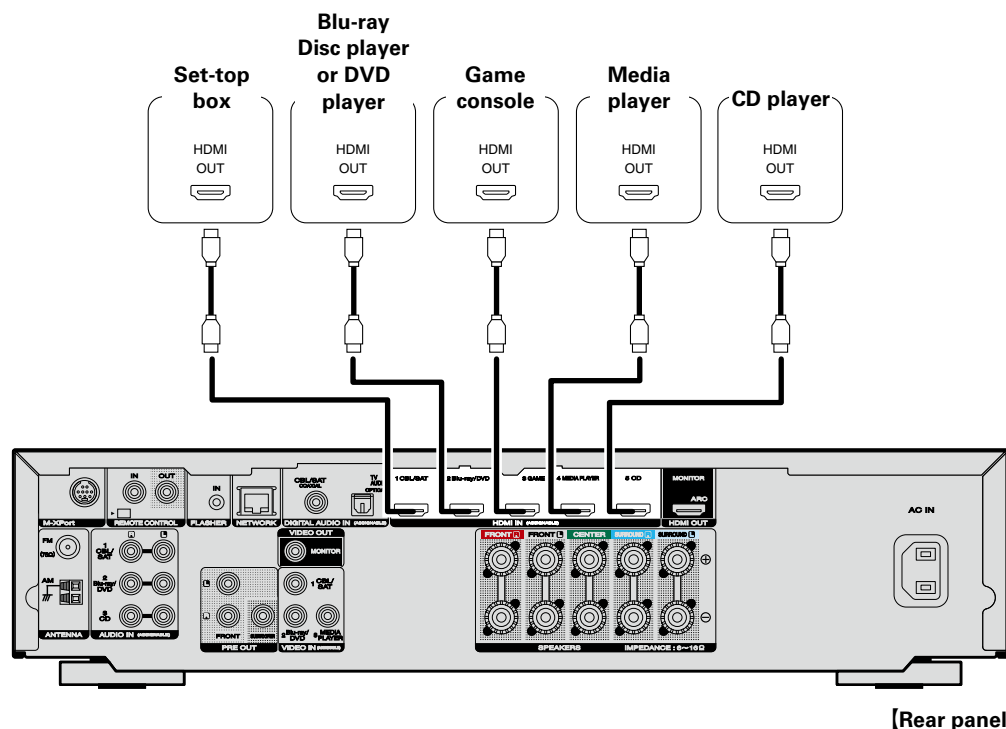
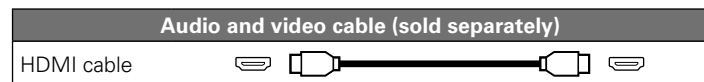

- When connecting a device that supports Deep Color, please use a “High Speed HDMI cable” or “High Speed HDMI cable with Ethernet”.
- Video signals are not output if the input video signals do not match the display’s resolution. In this case, switch the Blu-ray Disc/DVD player’s resolution to a resolution with which the display is compatible.

## HDMI function

This unit supports the following HDMI functions:

### □ About 3D function

This unit supports input and output of 3D (3 dimensional) video signals of HDMI.  
To play back 3D video, you need a TV and player that provide support for the HDMI 3D function and a pair of 3D glasses.

#### NOTE

- When playing back 3D video, refer to the instructions provided in the manual of your playback device together with this manual.
- If you operate the menu while playing back 3D video content, the playback video is replaced by the menu screen. The playback video is not displayed behind the menu screen.
- This unit does not show the status display while playing back 3D video content.
- If 3D video with no 3D information is input, the menu screen and status display on this unit are displayed over the playback video.
- If 2D video is converted to 3D video on the television, the menu screen and status display on this unit are not displayed correctly. To view the menu screen and status display on this unit correctly, turn the television setting that converts 2D video to 3D video off.

### □ HDMI pass through function (👉 page 100)

Signals input to the HDMI input connector are output to the television or other device connected to the HDMI output connector, even if the power of this unit is in standby.

### □ HDMI control function (👉 page 83)

This function allows you to operate external devices from the unit and operate the unit from external devices.

#### NOTE

- The HDMI control function may not work depending on the device it is connected to and its settings.
- You cannot operate a TV or Blu-ray Disc player/DVD player that is not compatible with the HDMI control function.

### □ About Content Type

This function was added with the HDMI standard. It automatically makes settings suitable for the video-output type (content information).

### □ Deep Color (👉 page 130)

When a device supporting Deep Color is connected (such as an HD camcorder), use a cable compatible with "High Speed HDMI cable" or "High Speed HDMI cable with Ethernet".

### □ Auto Lip Sync (👉 page 100, 130)

### □ "x.v.Color", sYCC601 color, Adobe RGB color, Adobe YCC601 color (👉 page 130, 131)

### □ High definition digital audio format

### □ ARC (Audio Return Channel) (👉 page 8)

#### Copyright protection system

In order to play back digital video and audio such as BD-Video or DVD-Video via HDMI connection, both this unit and TV or the player need to support the copyright protection system known as HDCP (High-bandwidth Digital Content Protection System). HDCP is copyright protection technology comprised of data encryption and authentication of the connected AV devices. This unit supports HDCP.

- If a device that does not support HDCP is connected, video and audio are not output correctly. Read the owner's manual of your television or player for more information.

## Settings related to HDMI connections

Set as necessary. For details, see the respective reference pages.

### □ HDMI Setup (👉 page 100)

Make settings for HDMI video/audio output.

- |                  |                     |                   |
|------------------|---------------------|-------------------|
| • Auto Lip Sync  | • HDMI Pass Through | • Pass Source     |
| • HDMI Audio Out | • HDMI Control      | • Pow.Off Control |

#### NOTE

To output audio signals that are input from the HDMI input connector to a TV connected via HDMI, set "HDMI Audio Out" (👉 page 100) to "TV".

## Connecting other devices





For highest quality video and surround playback, it is recommended to use an HDMI cable to connect this unit to TV and other video devices (see [page 7](#) "Connecting HDMI devices").

This section describes alternate connection methods when your device does not support HDMI connections.

### Connection methods for various devices

 TV	<a href="#">page 13</a>	 CBL/SAT	<a href="#">page 14</a>
 DVD	<a href="#">page 15</a>	 Blu-ray	<a href="#">page 15</a>
 MEDIA PLAYER	<a href="#">page 16</a>	 iPod/USB	<a href="#">page 17</a>
 CD	<a href="#">page 18</a>	 TUNER	<a href="#">page 19</a>
 Mi-XPoort	<a href="#">page 20</a>	 NETWORK	<a href="#">page 21</a>

### Cables used for connections

Video cable (sold separately)	
Video cable	
Audio cable (sold separately)	
Coaxial digital cable	
Optical cable	
Audio cable	
Cable (sold separately)	
LAN cable	

### Changing the source assigned to connectors

This unit can change the source that is assigned to the HDMI IN, DIGITAL AUDIO IN, VIDEO IN and AUDIO IN connectors.

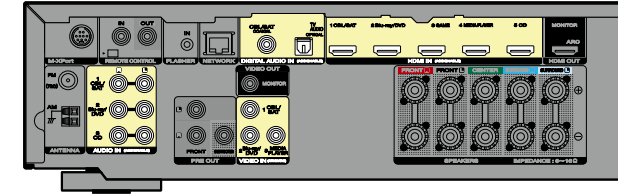

Let us take a digital audio connection for Blu-ray Disc players for an example. The rear panel digital audio input connectors do not have the input connector indication for Blu-ray disc players (Blu-ray). However, DIGITAL AUDIO IN connectors have the "ASSIGNABLE" indication, which means that you can change the source assigned to these connectors. You can assign Blu-ray disc players to these connectors. Select "Blu-ray" when switching functions on this unit to play back the source connected to these connectors.

#### How to change the source assigned to connectors ([page 103](#))

## Connecting a TV

- This section describes how to connect when your TV does not support ARC (Audio Return Channel). For instructions on HDMI connections, see “Connecting this unit to a TV via HDMI connections” ([page 9](#)).
- To listen to TV audio through this unit, use the optical digital connection.

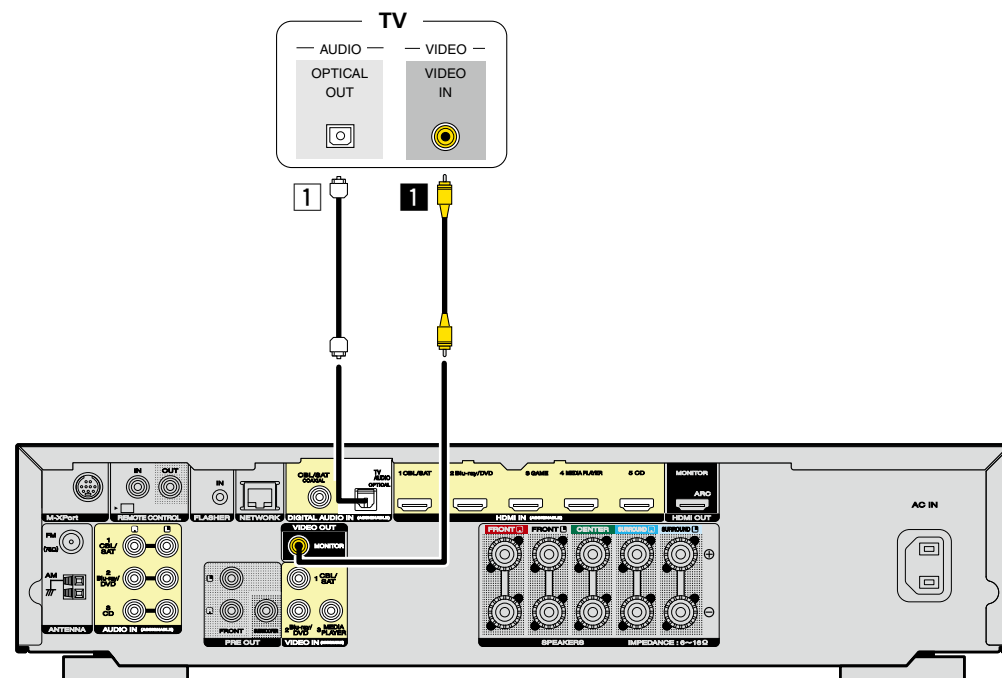

### NOTE

The menu screen is only displayed on TV connected to this unit via HDMI. If your TV is connected to this unit via other video output connectors, perform menu operations while seeing the display on this unit.

### Audio connection

The following methods are available for connecting to this unit.

#### 1 DIGITAL AUDIO OPTICAL connector

When a multichannel audio (digital bit stream audio) is input, this unit decodes the audio to play back surround sound.

### Video connection

The following methods are available for connecting to this unit.

#### 1 VIDEO OUT (MONITOR) connector

This makes an analog video connection.

The      sections in the connection diagram are also available for connections. To connect devices to these connectors, you must set up input connectors. For details, see “Input Assign” ([page 103](#)).



## Connecting a set-top box (Satellite tuner/cable TV)

This section describes how to connect when your satellite tuner or cable TV does not support HDMI connections.

For instructions on HDMI connections, see “Connecting HDMI devices” ([page 7](#)).

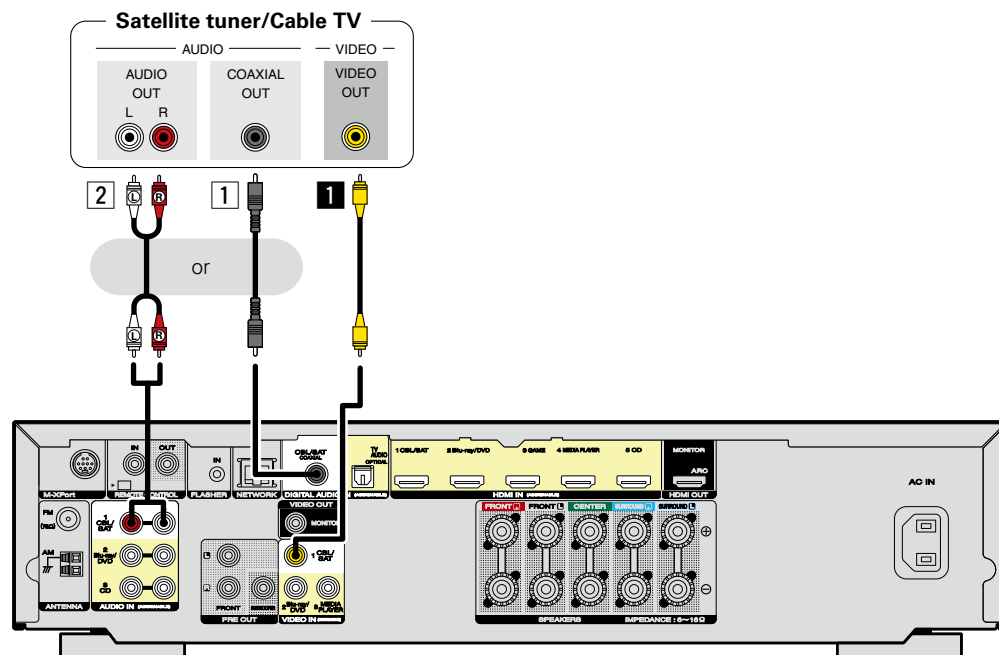

### Audio connection

The following methods are available for connecting to this unit. **Use either of the methods to make a connection.**

The numbers prefixed with connectors indicate the recommendation order. The smaller the number is, the higher playback quality is achieved.

#### 1 DIGITAL AUDIO COAXIAL connector

When a multichannel audio (digital bit stream audio) is input, this unit decodes the audio to play back surround sound.

#### 2 AUDIO IN (CBL/SAT) connector

This makes an analog audio connection.

### Video connection

The following methods are available for connecting to this unit.

#### 1 VIDEO IN (CBL/SAT) connector

This makes an analog video connection.

The      sections in the connection diagram are also available for connections. To connect devices to these connectors, you must set up input connectors. For details, see “Input Assign” ([page 103](#)).

## Connecting a Blu-ray Disc player or DVD player

This section describes how to connect when your Blu-ray disc player or DVD player that does not support HDMI connections.

For instructions on HDMI connections, see “Connecting HDMI devices” ([page 7](#)).

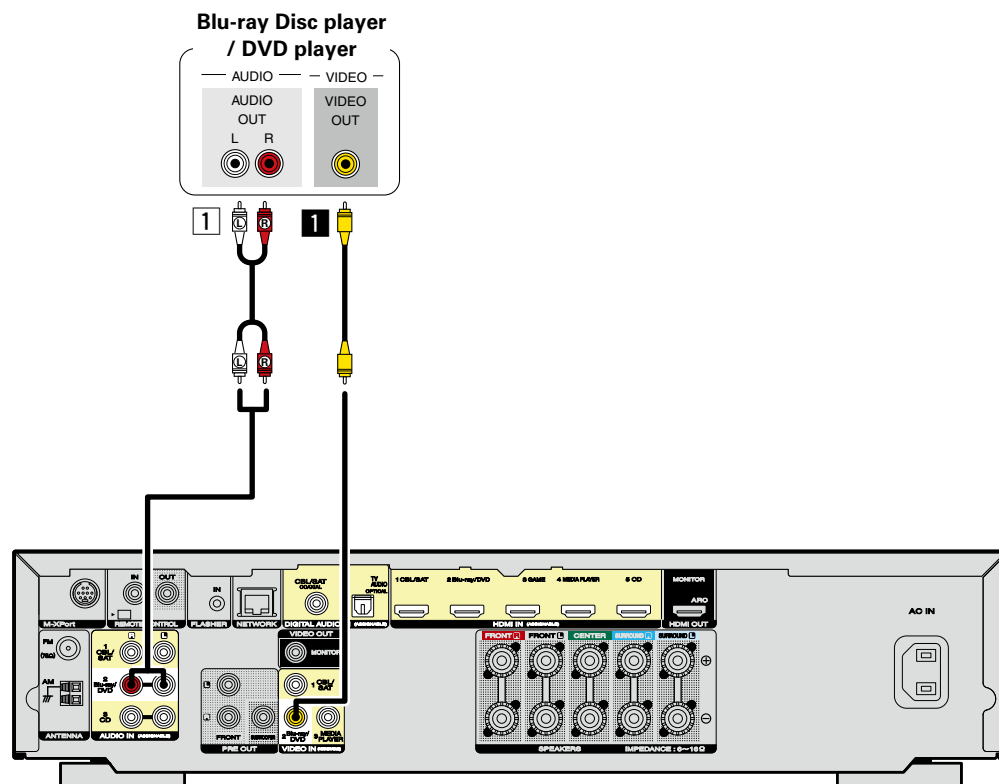

### Audio connection

The following methods are available for connecting to this unit.

#### 1 AUDIO IN (Blu-ray/DVD) connector

This makes an analog audio connection.

### Video connection

The following methods are available for connecting to this unit.

#### 1 VIDEO IN (Blu-ray/DVD) connector

This makes an analog video connection.

The        sections in the connection diagram are also available for connections. To connect devices to these connectors, you must set up input connectors. For details, see “Input Assign” ([page 103](#)).

## Connecting a media player

This section describes how to connect when your media player does not support HDMI connections. For instructions on HDMI connections, see “Connecting HDMI devices” ([page 7](#)).

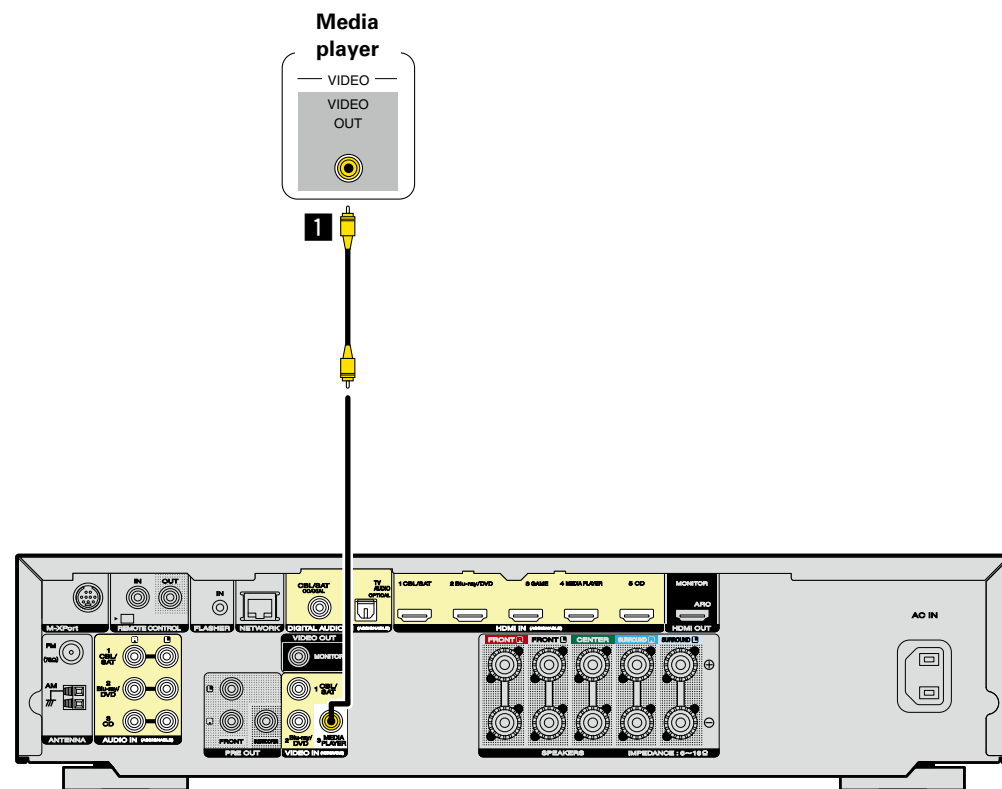

## Video connection

The following methods are available for connecting to this unit.

### 1 VIDEO IN (MEDIA PLAYER) connector

This makes an analog video connection.

The      sections in the connection diagram are also available for connections. To connect devices to these connectors, you must set up input connectors. For details, see “Input Assign” ([page 103](#)).

## Connecting an iPod or USB memory device to the USB port

- You can enjoy music stored on an iPod or USB memory device.
- For operating instructions see “Playing an iPod” ([page 32](#)) or “Playing a USB memory device” ([page 35](#)).

### Cables used for connections

To connect an iPod to this unit, use the USB adapter cable that was supplied with the iPod.

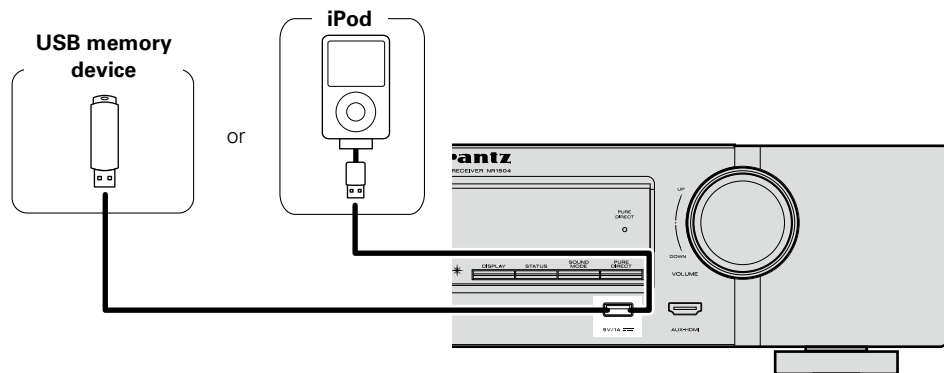

Marantz does not guarantee that all USB memory devices will operate or receive power. When using a portable USB hard disk drive (HDD) which came with an AC adapter, use that device's supplied AC adapter.

#### NOTE

- USB memory devices will not work via a USB hub.
- It is not possible to use this unit by connecting the unit's USB port to a PC via a USB cable.
- Do not use an extension cable when connecting a USB memory device. This may cause radio interference with other devices.
- When connecting an iPhone to this unit, keep the iPhone at least 20 cm (8 inches) away from this unit. If the iPhone is positioned close to this unit and a telephone call is received, noise may be output from this unit.
- If the iPod is connected using an iPod cable (commercially available) that is longer than 2 meters (6 feet) sound may not be played correctly. In this case, use a genuine iPod cable, or a cable that is shorter than 1 meter (3 feet).

### Supported iPod models

#### • iPod classic



iPod classic  
80GB



iPod classic  
160GB (2007)



iPod classic  
160GB (2009)

#### • iPod nano



iPod nano  
3rd generation  
(video)  
4GB 8GB



iPod nano  
4th generation (video)  
8GB 16GB



iPod nano  
5th generation (video camera)  
8GB 16GB



iPod nano  
6th generation  
8GB 16GB



iPod nano  
7th generation  
16GB

#### • iPod touch



iPod touch  
1st generation  
8GB 16GB 32GB



iPod touch  
2nd generation  
8GB 16GB 32GB



iPod touch  
3rd generation  
32GB 64GB



iPod touch  
4th generation  
8GB 32GB 64GB



iPod touch  
5th generation  
32GB 64GB

#### • iPhone



iPhone  
4GB 8GB 16GB



iPhone 3G  
8GB 16GB



iPhone 3GS  
8GB 16GB 32GB



iPhone 4  
8GB 16GB 32GB



iPhone 4S  
16GB 32GB 64GB



iPhone 5  
16GB 32GB 64GB

## Connecting a CD player

You can enjoy CD sound with the player connected by digital or analog cables.

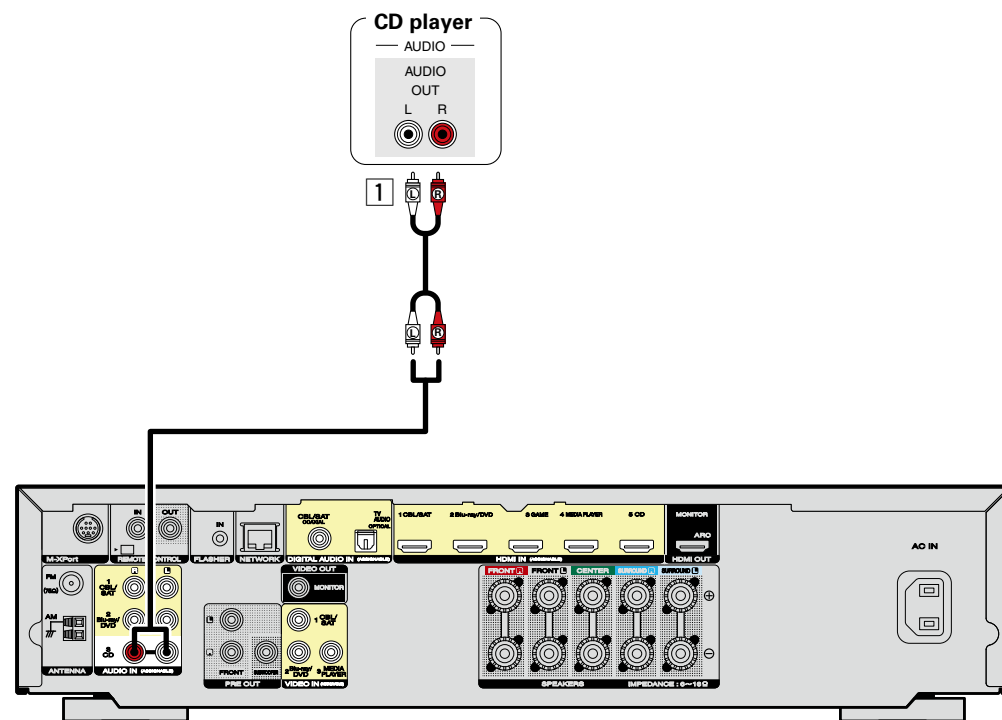

### Audio connection

The following methods are available for connecting to this unit.

#### 1 AUDIO IN (CD) connector

This makes an analog audio connection.

The        sections in the connection diagram are also available for connections. To connect devices to these connectors, you must set up input connectors. For details, see "Input Assign" ([page 103](#)).

## Connecting an FM/AM antenna

- Connect the FM antenna supplied with the unit to enjoy listening to radio broadcasts.
- After connecting the antenna and receiving a broadcast signal (see page 38 "Listening to FM/AM broadcasts"), fix the antenna with tape in a position where the noise level becomes minimal.

### AM loop antenna assembly

**1** Put the stand section through the bottom of the loop antenna from the rear and bend it forward.

**2** Insert the projecting part into the square hole in the stand.

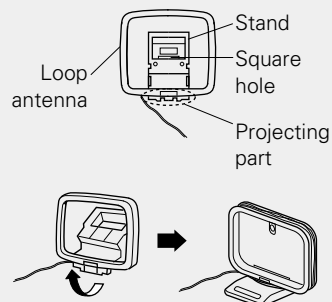

### Using the AM loop antenna

#### Suspending on a wall

Suspend directly on a wall without assembling.

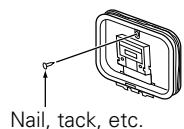

Nail, tack, etc.

#### Standing alone

Use the procedure shown above to assemble.

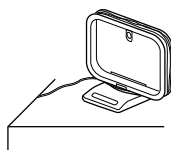

#### NOTE

- Do not connect two FM antennas simultaneously.
- Even if an external AM antenna is used, do not disconnect the AM loop antenna.
- Make sure the AM loop antenna lead terminals do not touch metal parts of the panel.
- If the signal has noise interference, connect the ground terminal (GND) to reduce noise.
- If you are unable to receive a good broadcast signal, we recommend installing an outdoor antenna. For details, inquire at the retail store where you purchased the unit.

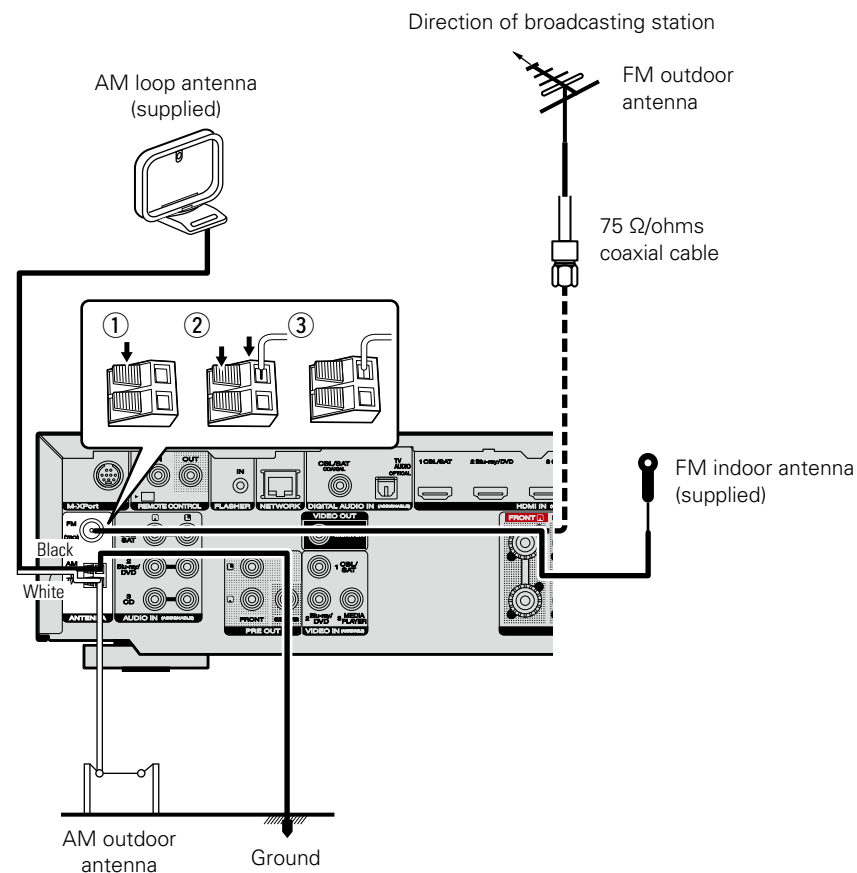

## Connecting a wireless receiver (RX101)

- You can connect a wireless receiver (RX101, sold separately) to play back music on your Bluetooth device with this unit.
- To do this, switch the input source to "M-XPort" ([page 30](#) "Selecting the input source").
- This unit supports the A2DP standard of the Bluetooth profile.
- See also the manuals for your wireless receiver and Bluetooth device.



- When connecting your Bluetooth device to the wireless receiver for the first time, pairing is necessary. Once pairing is completed, the communication between your Bluetooth device and the wireless receiver can be established just by connecting them. Pairing is necessary for each Bluetooth device.
- You can also use the wireless receiver as an IR receiver. In this case, disable the remote control signal receiving function ([page 88](#) "Remote lock function").

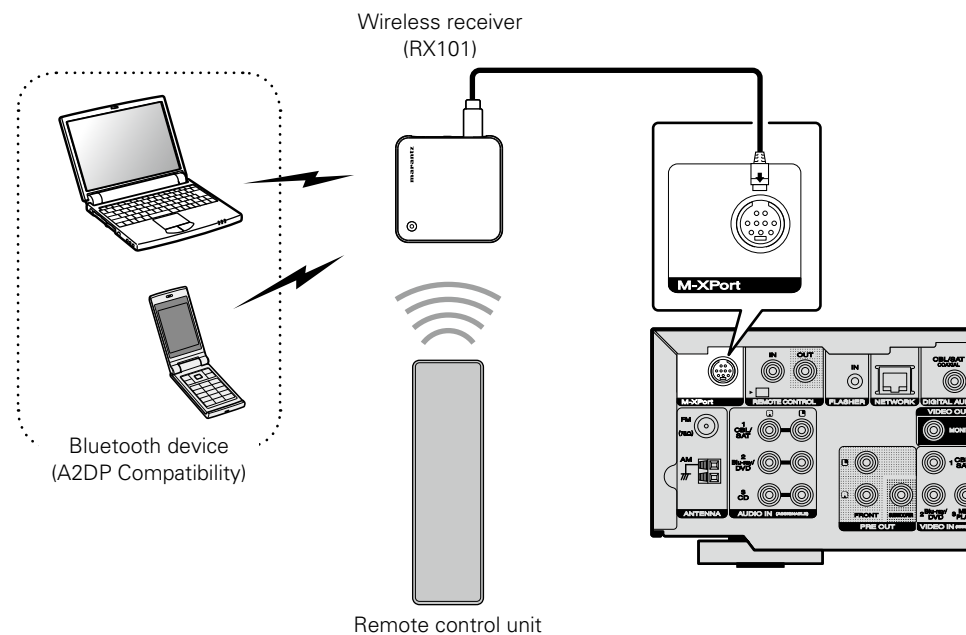

## Connecting to a home network (LAN)

You can connect this unit to your home network (LAN) to perform various types of playbacks and operations as follows. Make network connections for this unit by carefully reading information on this page.

- Playback of network audio such as Internet Radio and from your media server(s)
- Playback of music content from online streaming services
- Using the Apple AirPlay function
- Operation on this unit via the network

In addition, if updated firmware becomes available for this unit, the updated information is delivered from us to this unit over the internet via your home network. You can then download and install the latest firmware.

For more information, on the menu, select "Update" ([page 117](#)).

Network settings are necessary. See "Network" on the menu ([page 110](#)) for more information on network setting.

## Required system

### Broadband internet connection

### Modem

Device that connects to your broadband internet provider, and is very often supplied with the service. A type that is integrated with a router is also often available.

### Router

When using this unit, we recommend you use a router equipped with the following functions:

- Built-in DHCP server  
This function automatically assigns IP addresses on the LAN.
- Built-in 100BASE-TX switch  
When connecting multiple devices, we recommend a switching hub with a speed of 100 Mbps or greater.

### LAN cable (CAT-5 or greater recommended)

- Use only a shielded STP or ScTP LAN cable which is easily available at electronics stores.
- The normal shielded-type LAN cable is recommended. If a flat-type cable or unshielded-type cable is used, other devices could be affected by noise.



- If you have an Internet provider contract for a line on which network settings are made manually, make the settings at "Network" ([page 110](#)).
- With this unit, it is possible to use the DHCP and Auto IP functions to make the network settings automatically.
- When using this unit with the broadband router's DHCP function enabled, this unit automatically performs the IP address setting and other settings.  
When using this unit connected to a network with no DHCP function, make the settings for the IP address, etc., at "Network" ([page 110](#)).
- When setting manually, check the settings with the network administrator or internet service provider.

### NOTE

- A contract with an internet service provider (ISP) is usually required to connect to the Internet. No additional contract is needed if you already have a broadband connection to the Internet.
- The types of routers that can be used depend on the ISP. Contact your ISP or a computer shop for details.
- Marantz assumes no responsibility whatsoever for any communication errors or troubles resulting from the customer's network environment or connected devices.
- This unit is not compatible with PPPoE. A PPPoE-compatible router is required if you have a contract for a type of line set by PPPoE.
- Do not connect an NETWORK connector directly to the LAN port/ Ethernet connector on your computer.
- To listen to audio streaming, use a router that supports audio streaming.

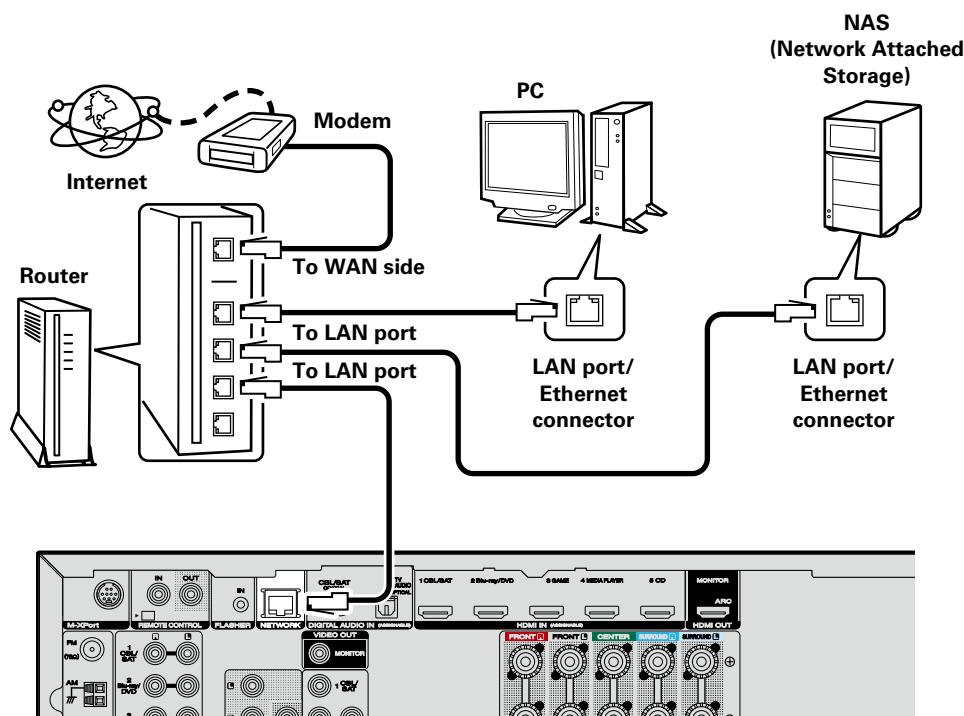

For connections to the Internet, contact an ISP (Internet Service Provider) or a computer shop.



## Connecting the power cord

After completing all the connections, insert the power plug into the power outlet.

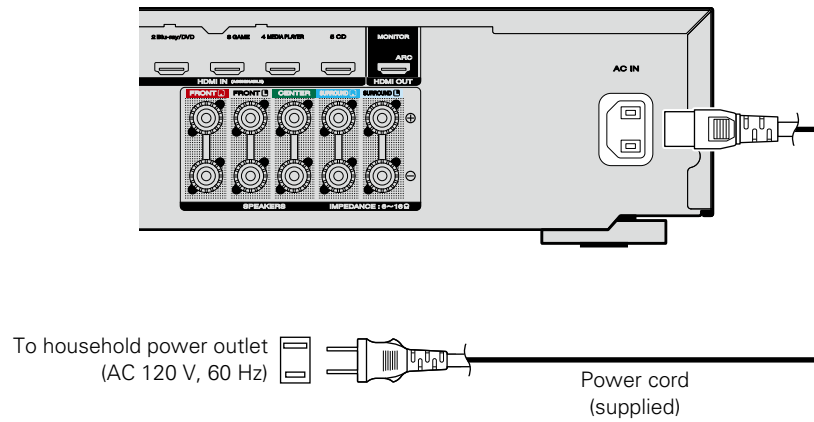

### NOTE

- Do not plug in the power cord until all connections have been completed. However, when the “Setup Assistant” is running, follow the instructions in the “Setup Assistant” (page 7) screen for making connections. (During “Setup Assistant” operation, the input/output connectors do not conduct current.)
- Do not bundle power cords together with connection cables. Doing so can result in humming or noise.

# Setup

Here, we explain “Audyssey® Setup”, which allows you to automatically make the optimal settings for your speakers, and “Network”, which allows you to connect this unit to a home network (LAN). This unit lets you play via your home network (LAN) music files stored on a computer and music content such as that from Internet Radio.

❑ **Speaker connection** (🔗 page 79)

❑ **Set up speakers (Audyssey® Setup)** (🔗 page 23)

❑ **Making the network settings (Network)**  
(🔗 page 29)

**Playback (Basic operation)** (🔗 page 30)

**Selecting a listening mode (Sound Mode)**  
(🔗 page 72)

**Playback (Advanced operation)** (🔗 page 83)



## Set up speakers (Audyssey® Setup)



The acoustic characteristics of the connected speakers and listening room are measured and the optimum settings are made automatically. This is called “Audyssey® Setup”.

To perform measurement, place the Setup and measurement microphone in multiple locations all around the listening area. For best results, we recommend you measure in six positions, as shown in the illustration (up to six positions).

- When performing Audyssey® Setup, Audyssey MultEQ®/Audyssey Dynamic EQ®/Audyssey Dynamic Volume® functions become active (🔗 page 97).
- To set up the speakers manually, use “Speakers” (🔗 page 106) on the menu.

### NOTE

- Make the room as quiet as possible. Background noise can disrupt the room measurements. Close windows and turn off the power on electronic devices (TVs, radios, air conditioners, fluorescent lights, etc.). The measurements could be affected by the sounds emitted by such devices.
- During the measurement process, place cell phones outside the listening room. Cell phone signals could disrupt the measurements.
- Do not unplug the Setup and measurement microphone from the main unit until Audyssey® Setup is completed.
- Do not stand between the speakers and Setup and measurement microphone or allow obstacles in the path while the measurements are being made. This will cause inaccurate readings.
- During the measurement process, audible test tones will come from the speakers and subwoofer(s), but this is part of normal operation. If there is background noise in the room, these test signals will increase in volume.
- Operating **VOLUME ▲▼** on the remote control unit or **VOLUME** on the main unit during the measurements will cancel the measurements.
- Measurement cannot be performed when headphones are connected. Unplug the headphones before performing Audyssey® Setup.

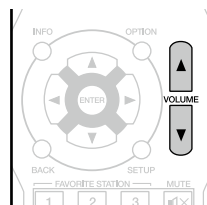

### About Setup and measurement microphone placement

- Measurements are performed by placing the Setup and measurement microphone successively at multiple positions throughout the entire listening area, as shown in [Example ①]. For best results, we recommend you measure in six positions, as shown in the illustration (up to six positions).
- Even if the listening environment is small as shown in [Example ②], measuring at multiple points throughout the listening environment results in more effective correction.

[Example ①]

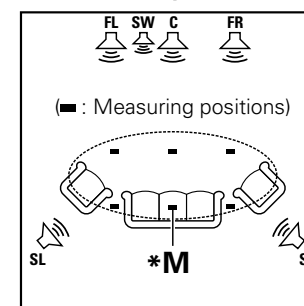

[Example ②]

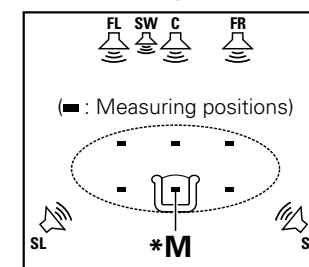

**FL** Front speaker (L)  
**FR** Front speaker (R)  
**C** Center speaker

**SW** Subwoofer  
**SL** Surround speaker (L)  
**SR** Surround speaker (R)

### About the main listening position (\*M)

The main listening position is the position where listeners would normally sit or where one would normally sit alone within the listening environment. Before starting Audyssey® Setup, place the Setup and measurement microphone in the main listening position. Audyssey MultEQ® uses the measurements from this position to calculate speaker distance, level, polarity, and the optimum crossover value for the subwoofer.

## 1 Prepare the included Setup and measurement microphone

Mount the Setup and measurement microphone on a tripod or stand and place it in the main listening position.

When placing the Setup and measurement microphone, adjust the height of the sound receptor to the level of the listener's ear.

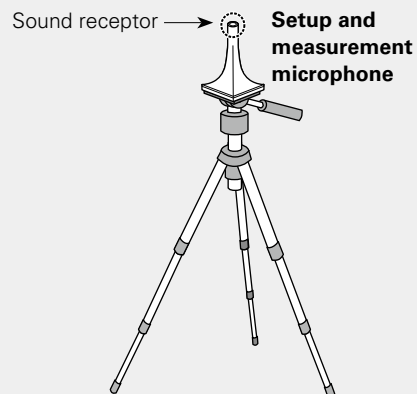

If you do not have a tripod or stand, set up the microphone on, for example, a seat without a back.

### NOTE

- Do not hold the Setup and measurement microphone in your hand during measurements.
- Avoid placing the Setup and measurement microphone close to a seat back or wall as sound reflections may give inaccurate results.

## 2 Set up the subwoofer

If using a subwoofer capable of the following adjustments, set up the subwoofer as shown below.

For details, see your subwoofer's manual.

### ❑ When using a subwoofer with a direct mode

Set the direct mode to "On" and disable the volume adjustment and crossover frequency setting.

### ❑ When using a subwoofer without a direct mode

Make the following settings:

- **Volume** : "12 o'clock position"
- **Crossover frequency** : "Maximum/Highest Frequency"
- **Low pass filter** : "Off"
- **Standby mode** : "Off"

## Preparation

### 3 Connect the Setup and measurement microphone to the SETUP MIC jack of this unit.

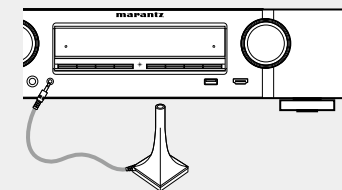

When the Setup and measurement microphone is connected, the following screen is displayed.

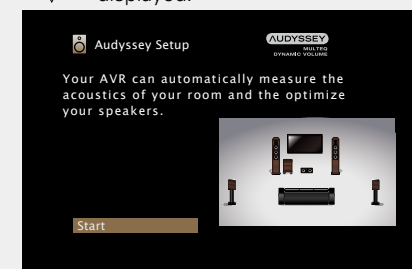

- For information about setting up and connecting the speakers, see "Installation/connection/setup of speakers (Advanced)" ([page 78](#)).
- For connection to a TV, see "Connecting this unit to a TV via HDMI connections" ([page 9](#)).

## Preparation (Continued)

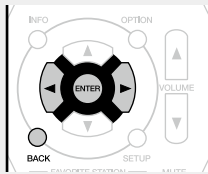
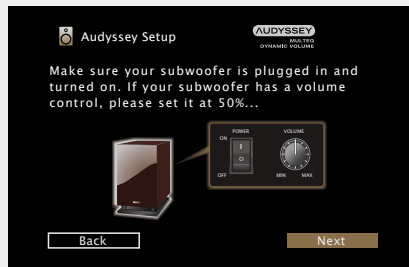
**4** Select “Start” and then press **ENTER**.**5** Select “Next” and then press **ENTER**.  
The subwoofer volume setting screen is displayed.

## Detection &amp; Measurement (Main)

This step automatically checks the speaker configuration and speaker size, and calculates the channel level, distance, and crossover frequency. It also corrects distortion in the listening area.

**6** Select “Begin Test” and then press **ENTER**.  
When measuring begins, a test tone is output from each speaker.

- Measurement requires several minutes.

**7** The detected speakers are displayed.

- The illustration below shows an example of when the front speakers, center speaker, subwoofer and surround speakers have been detected.

**NOTE**

If a connected speaker is not displayed, the speaker may not be connected correctly. Check the speaker connection.

**8** Select “Next” and then press **ENTER**.**NOTE**

If “Caution!” is displayed on TV screen:

Go to “Error messages” ([page 28](#)). Check any related items, and perform the necessary procedures.

If the problem is resolved, return and restart “Audyssey® Setup”.

**Going back to the previous screen**

Select “Back” and then press **ENTER**.

**When measuring has stopped**

- ① Press **BACK** to display the popup screen.
- ② Press **<** to select “Yes”, and then press **ENTER**.

**Setting up the speakers again**

Repeat the operation from step 4.

## Measurement (2nd – 6th)

- In this step, you will perform measurements at multiple positions (one to five additional positions) other than the main listening position.
- Just one listening position can be measured if you so choose, but measuring multiple positions increases the accuracy of the correction of acoustic distortion within the listening area.

### 9 Move the Setup and measurement microphone to position 2, select “Continue”, and then press ENTER.

The measurement of the second position starts. Measurements can be made in up to six positions.

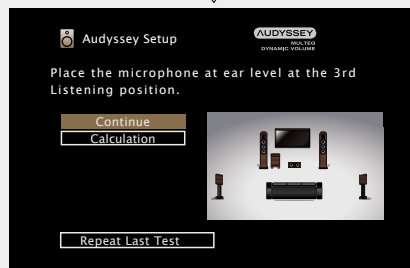
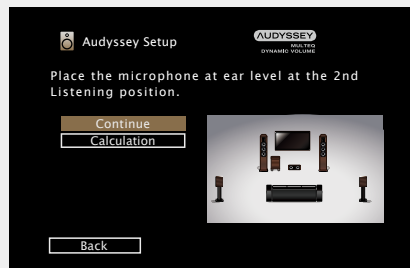
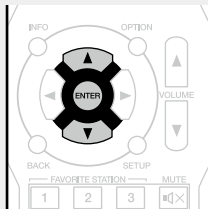

- To skip measuring the second and subsequent listening position, use ▾ to select “Calculation” and press **ENTER** to proceed to step 12.
- To measure the second position again, use ▾ to select “Repeat Last Test” and press **ENTER**.

## Calculation

- 10 Repeat step 9, measuring positions 3 to 6.**  
When measurement of position 6 is completed, a “Measurements Complete.” message is displayed.

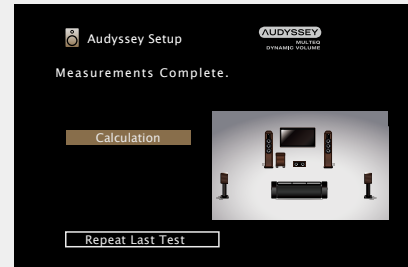

- 11 Select “Calculation” and then press ENTER.**  
Measuring results are analyzed, and the frequency response of each speaker in the listening room is determined.

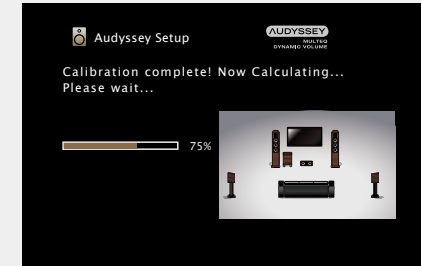

- Analysis takes several minutes to complete. The more speakers and measurement positions that there are, the more time it takes to perform the analysis.

## Check

**12** Use  $\Delta$ / $\nabla$  to select the item you want to check, and then press **ENTER**.

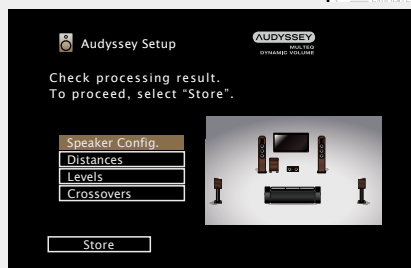
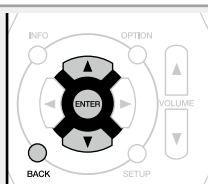

- Subwoofers may measure a greater reported distance than the actual distance due to added electrical delay common in subwoofers.
- If you want to check another item, press **BACK**.

**NOTE**

- If the result differs from the actual connection status, or if "Caution!" is displayed, see "Error messages" ([page 28](#)). Then carry out Audyssey® Setup again.
- If you change speaker positions or orientation, perform Audyssey® Setup again to find the optimal equalizer settings.

## Store

**13** Select "Store" and then press **ENTER**.  
Save the measurement results.

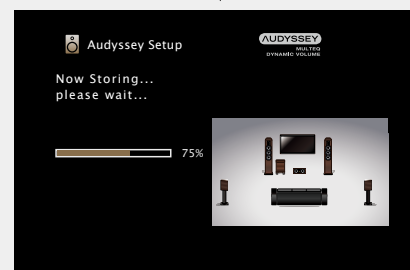
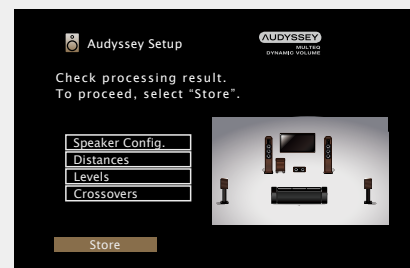

- Saving the results requires about 20 seconds.
- During saving of measurements results, "Now storing...Please wait..." is displayed. When saving is completed, "Storing complete. Audyssey® Setup is now finished. Please unplug microphone." is displayed.

**NOTE**

During saving of measurement results, be sure not to turn off the power.

## Finish

**14** Unplug the Setup and measurement microphone from the unit's SETUP MIC jack.

**15** Set Audyssey Dynamic Volume®.

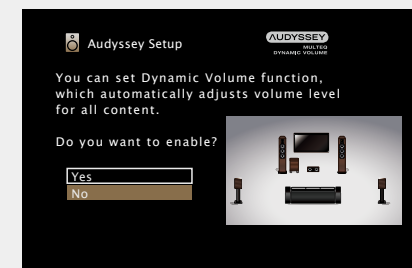

- This feature adjusts the output volume to the optimal level while constantly monitoring the level of the audio input to the unit. Optimal volume control is performed automatically without any loss in the dynamism and clarity of the sound when, for example, the volume suddenly increases for commercials shown during television programs.

**When turning Dynamic Volume on**

- Press  $\Delta$  to select "Yes", and then press **ENTER**.

The unit automatically enters "Medium" ([page 97](#)) mode.

**When turning Dynamic Volume off**

- Press  $\nabla$  to select "No", and then press **ENTER**.

**NOTE**

After performing Audyssey® Setup, do not change the speaker connections or subwoofer volume. In event of a change, perform Audyssey® Setup again.

## Error messages

### NOTE

- An error message is displayed if Audyssey® Setup could not be completed due to speaker placement, the measurement environment, etc. If an error message is displayed, check the relevant items and perform the necessary measures. Then perform Audyssey® Setup again.
- If the result still differs from the actual connection status after re-measurement or the error message still appears, it is possible that the speakers are not connected properly. Turn this unit off, check the speaker connections and repeat the measurement process from the beginning.
- Be sure to turn off the power before checking speaker connections.

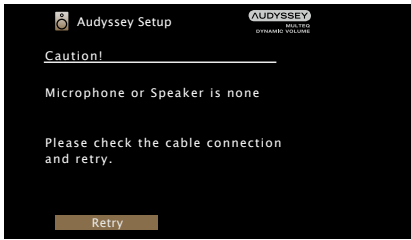
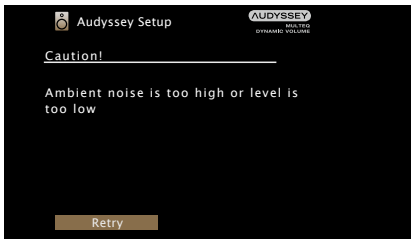
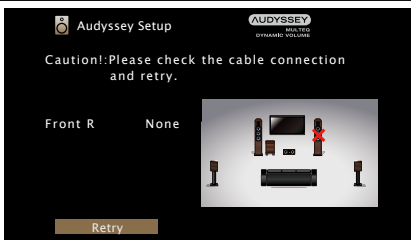
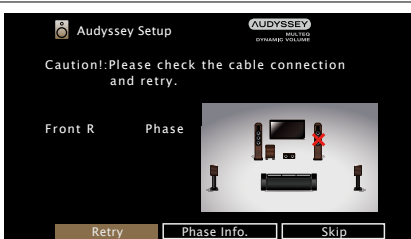
Examples	Error details	Measures
	<ul style="list-style-type: none"> <li>• The connected Setup and measurement microphone is broken, or a device other than the supplied Setup and measurement microphone is connected.</li> <li>• Not all speakers could be detected.</li> </ul>	<ul style="list-style-type: none"> <li>• Connect the included Setup and measurement microphone to the SETUP MIC jack of this unit.</li> <li>• Check the speaker connections.</li> </ul>
	<ul style="list-style-type: none"> <li>• There is too much noise in the room for accurate measurements to be made.</li> <li>• Speaker or subwoofer sound is too low for accurate measurements to be made.</li> </ul>	<ul style="list-style-type: none"> <li>• Either turn off any device generating noise or move it away.</li> <li>• Perform again when the surroundings are quieter.</li> <li>• Check the speaker installation and the direction in which the speakers are facing.</li> <li>• Adjust the subwoofer's volume.</li> </ul>
	<ul style="list-style-type: none"> <li>• The displayed speaker could not be detected. (The screen on the left indicates that the front right speaker cannot be detected.)</li> </ul>	<ul style="list-style-type: none"> <li>• Check the connections of the displayed speaker.</li> </ul>
	<ul style="list-style-type: none"> <li>• The displayed speaker is connected with the polarity reversed. (The screen on the left indicates that the polarity phases of the front right speakers are reversed.)</li> </ul>	<ul style="list-style-type: none"> <li>• Check the polarity of the displayed speaker.</li> <li>• For some speakers, this error message may be displayed even if the speaker is properly connected. If you are sure the connection is correct, use <b>▷</b> to select "Skip", then press <b>ENTER</b>.</li> </ul>

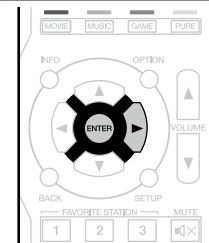

## Check Results

This function enables you to check the measurement results and equalizer characteristics after Audyssey® Setup.

- 1 Press **SETUP** to display the menu on the TV screen.
- 2 Use **△** to select “Speakers” – “Audyssey® Setup” and then press **ENTER** or **▷**.
- 3 Use **△** to select “Check Results” and then press **ENTER**.



- 4 Use **△**/**▽** to select the item you want to check, then press **ENTER**.  
Measurement results for each speaker are displayed.

<b>Speaker Config.</b>	Check the speaker configuration.
<b>Distances</b>	Check the speaker distance.
<b>Levels</b>	Check the speaker channel level.
<b>Crossovers</b>	Check the speaker crossover frequency.

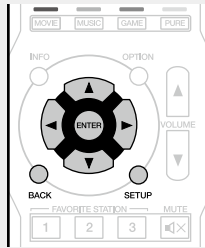

- 5 Press **◀** or **BACK**.  
The confirmation screen reappears. Repeat step 2.

## Retrieving Audyssey® Setup settings

If you set “Restore...” to “Restore”, you can return to Audyssey® Setup measurement result (value calculated at the start by MultEQ®) even when you have changed each setting manually.



## Making the network settings (Network)



This unit can be connected to a home network (LAN) to listen to Internet Radio or play back music files and still image (JPEG) files stored on a computer.

- 1 Connect the LAN cable (☞ [page 21](#) “Connecting to a home network (LAN)”).
- 2 Turn on this unit (☞ [page 30](#)).  
This unit performs automatic network setup due to the DHCP function.  
When connecting to a network that has no DHCP function, perform the setting in “Settings” (☞ [page 112](#)).



# Playback (Basic operation)

## Setup (👉 page 23)

- ❑ Turning the power on (👉 page 30)
- ❑ Selecting the input source (👉 page 30)
- ❑ Adjusting the master volume (👉 page 31)
- ❑ Turning off the sound temporarily (👉 page 31)

## ❑ Playing a Blu-ray Disc player/DVD player (👉 page 31)

- ❑ Playing a CD player (👉 page 31)
- ❑ Playing an iPod (👉 page 32)
- ❑ Playing a USB memory device (👉 page 35)
- ❑ Listening to FM/AM broadcasts (👉 page 38)

## ❑ Listening to Internet Radio (👉 page 47)

- ❑ Playing back files stored on a PC and NAS (👉 page 50)
- ❑ Using online services (👉 page 54)
- ❑ Convenient functions (👉 page 65)
- ❑ AirPlay function (👉 page 70)

## Selecting a listening mode (Sound Mode)

(👉 page 72)

## Playback (Advanced operation) (👉 page 83)

## Important information

Before starting playback, make the connections between the different devices and the settings on the unit.

### NOTE

Also refer to the operating instructions of the connected devices when playing them.

## Turning the power on

Press **POWER**  to turn on power to the unit.

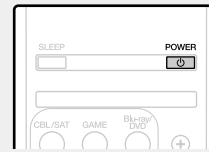

You can also switch the power to standby by pressing  on the main unit.

## ❑ When power is switched to standby

Press **POWER** .

### [Power indicator status in standby mode]

Normal standby : Red

- When "HDMI Pass Through" or "HDMI Control" (👉 page 100) is set to "On" : Orange
- When "IP Control" (👉 page 111) is set to "Always On" : Orange

## Selecting the input source

Press the input source select button (**CBL/SAT, GAME, Blu-ray/DVD, MEDIA PLAYER, AUX, TUNER, TV AUDIO, M-XPport, CD, NETWORK, iPod/USB or INTERNET RADIO**) to be played back.

The desired input source can be selected directly.

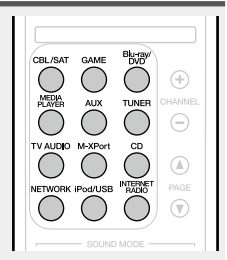

You can also use the following operation to select an input source.

## ❑ Select the input source using the main unit

Turn **INPUT SELECTOR**.

- Turning **INPUT SELECTOR** switches the input source, as shown below.

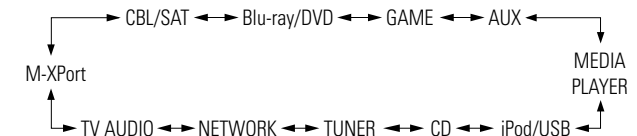

## Adjusting the master volume

Use **VOLUME ▲▼** to adjust the volume.

- The volume display method varies depending on the "Scale" setting (see page 96).

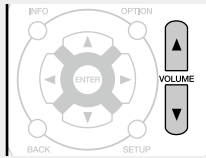

- When the "Scale" setting (see page 96) is "0 – 98"

[Adjustable range] 0.0 0.5 – 98.0

- When the "Scale" setting (see page 96) is "–79.5dB – 18.0dB"

[Adjustable range] --- -- –79.5dB – 18.0dB

- The variable range differs according to the input signal and channel level setting.



You can also adjust the master volume by turning **VOLUME** on the main unit.

## Turning off the sound temporarily

Press **MUTE** .

- "MUTE" indicator on the display flashes.
-  appears on the TV screen.



- The sound is reduced to the level set at "Mute Level" (see page 96).
- To cancel, press **MUTE**  again. Muting can also be cancelled by adjusting the master volume.

## Playing a Blu-ray Disc player/DVD player

The following describes the procedure for playing Blu-ray Disc player/DVD player.

### 1 Prepare for playback.

- Turn on the power of the TV, subwoofer and player.
- Change the TV input to the input of this unit.
- Load the disc in the player.

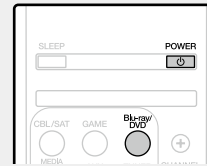

### 2 Press **POWER** to turn on power to the unit.

### 3 Press **Blu-ray/DVD** to switch an input source for a player used for playback.

### 4 Play the Blu-ray Disc player or DVD player.

- Make the necessary settings on the player (language setting, subtitles setting, etc.) beforehand.

## Playing a CD player

The following describes the procedure for playing CD player.

### 1 Prepare for playback.

- Turn on the power of the subwoofer and player.
- Load the disc in the player.

### 2 Press **POWER** to turn on power to the unit.

### 3 Press **CD** to switch the input source to "CD".

### 4 Play the CD player.

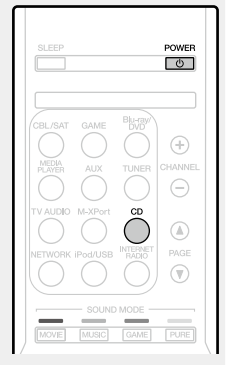

## Playing an iPod

You can use the USB cable provided with the iPod to connect the iPod with the unit's USB port and enjoy music stored on the iPod.

For information on the iPod models that can be played back with this unit, see "Connecting an iPod or USB memory device to the USB port" ([page 17](#)).

## Listening to music on an iPod

The iPod display modes include "From iPod" and "On-Screen". By default, "From iPod", where you directly operate the iPod itself while looking at the iPod screen, is set.

To change to "On-Screen", where you perform operations while having the iPod information displayed on the TV screen, see "Setting operation mode (iPod Browse Mode)" ([page 33](#)).

**1** Using the USB cable provided with the iPod, connect the iPod to the USB port ([page 17](#)).

**2** Press **POWER**  to turn on power to the unit.

**3** Press **iPod/USB** to switch the input source to "iPod/USB". "Browse From iPod" is displayed on the display of this unit.

- Nothing is displayed on the TV screen.

**4** Operate iPod itself directly while seeing the iPod screen to play back music.

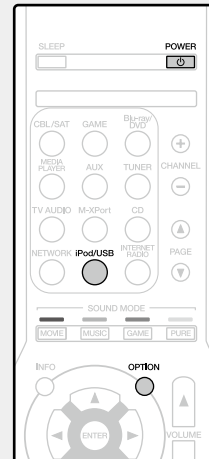

Streaming music stored in iPhone, iPod touch, or iPad directly to the unit ([page 70](#))

Playing iTunes music with this unit ([page 70](#))

## Operations available through the OPTION button

Press the **OPTION** button to display a menu of functions that can be used on the TV screen. Select the function you want to use from this menu. You can easily find and use the desired function.

Performing repeat playback (Repeat) ([page 34](#))

Performing random playback (Random) ([page 34](#))

Setting operation mode (iPod Browse Mode) ([page 33](#))

Displaying your desired video on the monitor during audio playback (Video Select) ([page 69](#))

**Setting operation mode (iPod Browse Mode)**

In this mode, various lists and screens during playback on the iPod are displayed on the TV screen. This section describes the steps up to playing back tracks on the iPod in "On-Screen".

**1 Press iPod/USB to switch the input source to "iPod/USB".**

**2 Press OPTION.**  
The option menu screen is displayed.

**3 Select "iPod Browse Mode", then press ENTER.**  
The "iPod Browse Mode" screen is displayed.

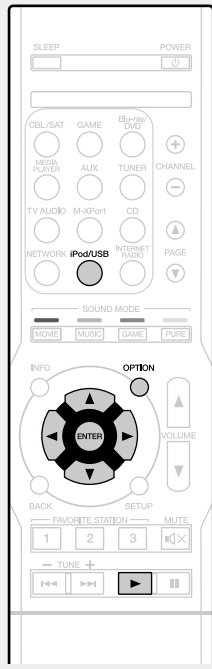
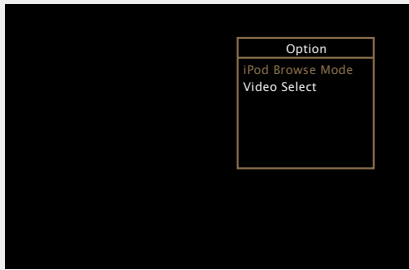

**4 Use < and > to select "On-Screen", then press ENTER.**  
The iPod screen is displayed.

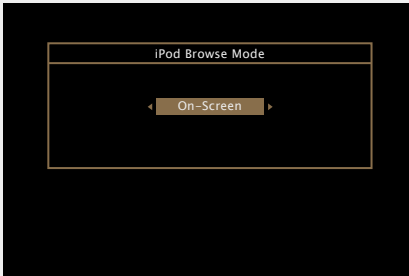

- English letters, numbers and certain symbols are displayed. Incompatible characters are displayed as "." (period).
- Operations available for "On-Screen" and "From iPod" are listed below.

Display mode		From iPod	On-Screen
Playable files	Music file	✓	✓
	Video file	*	
Active buttons	Remote control unit (This unit)	✓	✓
	iPod	✓	

\* Only the sound is played.

**5 Use Δ and ∇ to select the item, then press ENTER or > to select the file to be played.**

**6 Press ENTER, > or >>.**  
Playback starts.

**Adjusting the sound quality (M-DAX)**

Make this setting at "M-DAX" (page 96) in the menu. You can use the M-DAX function to improve the fidelity of compressed audio sources such as MP3 files. The M-DAX has selectable levels of restoration. The default setting is "Off".

**Changing the screen display duration**

Make this setting at "Now Playing" (page 101) in the menu. The default setting is "Always On". When "Auto Off" is set, the on-screen display is turned off 30 seconds after an operation. Press Δ∇< > while the display is off to return to the original screen.

**Switching the screen display**

Press **STATUS** on this unit during playback with "iPod Browse Mode" set to "On-Screen". The display switches between track title, artist name, and album title etc. each time the button is pressed.

**NOTE**

- Depending on the type of iPod and the software version, some functions may not operate.
- Note that Marantz will accept no responsibility whatsoever for any problems arising with the data on an iPod when using this unit in conjunction with the iPod.

**Performing repeat playback (Repeat)**

**1** Press **OPTION** with “iPod Browse Mode” set to “On-Screen”.  
The option menu screen is displayed.

**2** Use  $\Delta$ / $\nabla$  to select “Repeat”, then press **ENTER**.

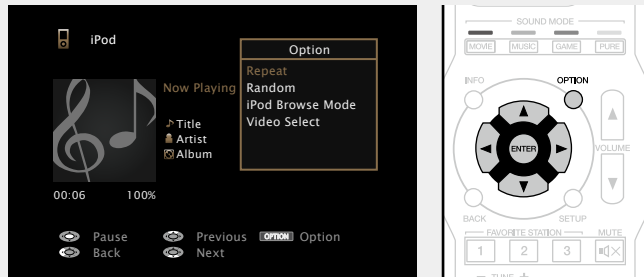

**3** Use  $\triangleleft$ / $\triangleright$  to select repeat playback mode.

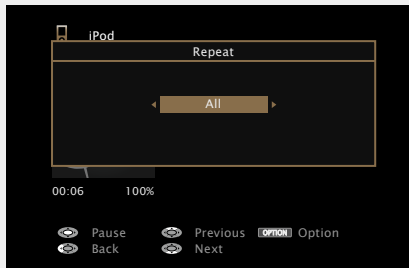

• Each time  $\triangleleft$ / $\triangleright$  is pressed, the setting is changed as shown below.



- Off** Repeat playback mode is canceled.
- One** A file being played is played repeatedly.
- All** All files in the folder currently being played are played repeatedly.

**4** Press **ENTER**.  
The display returns to the playback screen.

**Performing random playback (Random)**

**1** Press **OPTION** with “iPod Browse Mode” set to “On-Screen”.  
The option menu screen is displayed.

**2** Use  $\Delta$ / $\nabla$  to select “Random”, then press **ENTER**.

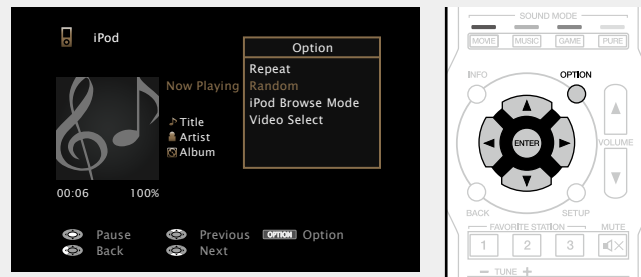

**3** Use  $\triangleleft$ / $\triangleright$  to select random playback mode.

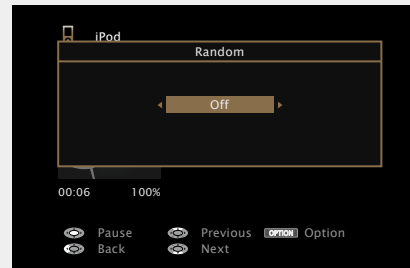

• Each time  $\triangleleft$ / $\triangleright$  is pressed, the setting is changed as shown below.



- Off** Disable random playback.
- On** Randomly play back all tracks in the current playback folder.

**4** Press **ENTER**.  
The display returns to the playback screen.



During random playback, each time playback of a track is completed, another track is randomly selected for playback from tracks in the folder. Therefore, it's possible that you may hear a track played back more than once during random playback.

**iPod operation buttons**

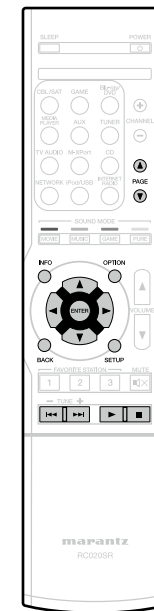

Operation buttons	Function
<b>PAGE</b> $\Delta$ / $\nabla$	Page search
<b>INFO</b>	Display of information such as the source name, volume, and sound mode name
<b>OPTION</b>	Repeat playback / Random playback / iPod Browse Mode switching / Video Select
$\Delta$ / $\nabla$ / $\triangleleft$ / $\triangleright$	Cursor operation / Next/Previous ( $\Delta$ / $\nabla$ ) / Fast-forward/Fast-reverse (Press and hold, $\Delta$ / $\nabla$ )
<b>ENTER</b> (Press and release)	Enter / Playback / Pause
<b>ENTER</b> (Press and hold)	Stop
<b>BACK</b>	Return
<b>SETUP</b>	Setup menu
$\lll$ $\ggg$ (Press and release)	Next/Previous
$\lll$ $\ggg$ (Press and hold)	Fast-forward/Fast-reverse
$\blacktriangleright$	Playback
<b>II</b>	Pause

# Playing a USB memory device

Playing back music or viewing still picture (JPEG) files stored on a USB memory device.

## Important information

- Only USB memory devices conforming to mass storage class and MTP (Media Transfer Protocol) standards can be played on this unit.
- This unit is compatible with USB memory devices in “FAT16” or “FAT32” format.
- This unit is compatible with MP3 files conforming to “MPEG-1 Audio Layer-3” standards.
- File types that this unit can play back and specifications are shown below.

### [Supported file types]

Supported file types	USB memory devices *1
<b>WMA</b> (Windows Media Audio)	✓*2
<b>MP3</b> (MPEG-1 Audio Layer-3)	✓
<b>WAV</b>	✓
<b>MPEG-4 AAC</b>	✓*3
<b>FLAC</b> (Free Lossless Audio Codec)	✓
<b>JPEG</b>	✓
<b>ALAC</b> (Apple Lossless Audio Codec)	✓

\*1 USB memory device

- This unit is compatible with MP3 ID3-Tag (Ver. 2) standard.
- This unit can show the artwork that was embedded by using MP3 ID3-Tag Ver. 2.3 or 2.4.
- This unit is compatible with WMA META tags.
- If the image size (pixels) of an album artwork exceeds 500 × 500 (WMA/MP3/WAV/FLAC) or 349 × 349 (MPEG-4 AAC), then music may not be played back properly.
- WAV format Quantization bit length: 16 or 24 bits.
- FLAC format Quantization bit length: 16 or 24 bits.

\*2 Copyright-protected files can be played on certain portable players compatible with MTP.

\*3 Only files that are not protected by copyright can be played on this unit.

Content downloaded from pay sites on the Internet are copyright protected. Also, files encoded in WMA format when ripped from a CD, etc. on a computer may be copyright protected, depending on the computer’s settings.

### NOTE

File types that this unit does not support are not displayed.

### [Compatible formats]

	Sampling frequency	Bit rate	Extension
<b>WMA</b> (Windows Media Audio)	32/44.1/48 kHz	48 – 192 kbps	.wma
<b>MP3</b> (MPEG-1 Audio Layer-3)	32/44.1/48 kHz	32 – 320 kbps	.mp3
<b>WAV</b>	32/44.1/48/88.2/96/ 176.4/192 kHz	–	.wav
<b>MPEG-4 AAC</b>	32/44.1/48 kHz	16 – 320 kbps	.aac/ .m4a/ .mp4
<b>FLAC</b> (Free Lossless Audio Codec)	32/44.1/48/88.2/96/ 176.4/192 kHz	–	.flac
<b>ALAC</b> (Apple Lossless Audio Codec)*	32/44.1/48/88.2/96 kHz	–	.m4a

\* Copyright [2012] [D&M Holdings. Inc.]

Licensed under the Apache License, Version 2.0 (the “License”); you may not use this file except in compliance with the License. You may obtain a copy of the License at <http://www.apache.org/licenses/LICENSE-2.0>

### □ Maximum Number of Playable Files and Folder

The limits on the number of folders and files that can be displayed by this unit are as follows.

Item	Media	USB memory devices
Memory capacity		FAT16 : 2 GB, FAT32 : 2 TB
Number of folder directory levels *1		8 levels
Number of folders		500
Number of files *2		5000

\*1 The limited number includes the root folder.

\*2 The allowable number of files may differ according to the USB memory device capacity and the file size.

## Playing files stored on USB memory devices

**1** Connect the USB memory device to the USB port (🔗 [page 17](#)).

**2** Press iPod/USB to switch the input source to “iPod/USB”.

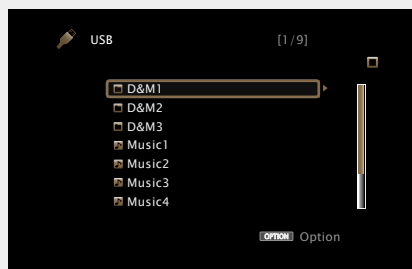

**3** Use  $\Delta$ / $\nabla$  to select the search item or folder, then press **ENTER** or  $\triangleright$ .

**4** Use  $\Delta$ / $\nabla$  to select the file, then press **ENTER**,  $\triangleright$  or  $\blacktriangleright$ . Playback starts.

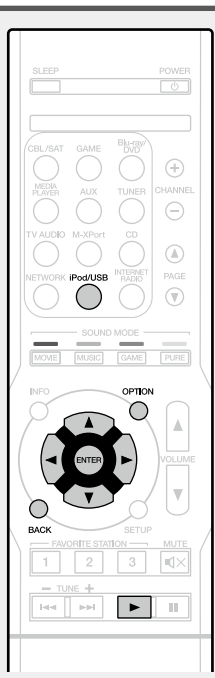

### ❑ Adjusting the sound quality (M-DAX)

Make this setting at “M-DAX” (🔗 [page 96](#)) in the menu. You can use the M-DAX function to improve the fidelity of compressed audio sources such as MP3 files. The M-DAX has selectable levels of restoration. The default setting is “Off”.

### ❑ Going back to the previous screen

Press  $\triangleleft$  or **BACK**.

### ❑ Changing the screen display duration

Make this setting at “Now Playing” (🔗 [page 101](#)) in the menu. The default setting is “Always On”. When “Auto Off” is set, the on-screen display is turned off 30 seconds after an operation. Press  $\Delta$ / $\nabla$ / $\triangleleft$   $\triangleright$  while the display is off to return to the original screen.



- When an MP3 music file includes album art data, the album art can be displayed while playing the file.
- If the USB memory device is divided into multiple partitions, only the first partition is played back.

### NOTE

- Note that Marantz will accept no responsibility whatsoever for any problems arising with the data on a USB memory device when using this unit in conjunction with the USB memory device.
- USB memory devices will not work via a USB hub.
- Marantz does not guarantee that all USB memory devices will operate or be supplied power. When using a USB portable hard disk that can draw power from an AC adapter, we recommend using the AC adapter.
- It is not possible to connect and use a computer via the USB port of this unit using a USB cable.

## Operations available through the OPTION button

Press the **OPTION** button to display a menu of functions that can be used on the TV screen. Select the function you want to use from this menu. You can easily find and use the desired function.

### ❑ Searching content with keywords (Text Search) (🔗 [page 65](#))

### ❑ Performing repeat playback (Repeat) (🔗 [page 65](#))

### ❑ Performing random playback (Random) (🔗 [page 66](#))

### ❑ Playing back still images in sequential order (Slideshow Time) (🔗 [page 68](#))

### ❑ Displaying your desired video on the monitor during audio playback (Video Select) (🔗 [page 69](#))

□ USB memory device operation buttons

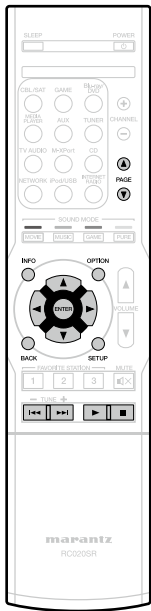

Operation buttons	Function
<b>PAGE ▲▼</b>	Page search
<b>INFO</b>	Display of information such as the source name, volume, and sound mode name etc.
<b>OPTION</b>	Text Search / Repeat playback / Random playback / Slideshow Time / Video Select
△▽◀▶	Cursor operation / Next/Previous (△▽) / Fast-forward/Fast-reverse (Press and hold, △▽)*
<b>ENTER</b> (Press and release)	Enter
<b>ENTER</b> (Press and hold)	Stop
<b>BACK</b>	Return
<b>SETUP</b>	Setup menu
<b>◀▶▶▶</b> (Press and release)	Next/Previous
<b>◀▶▶▶</b> (Press and hold)	Fast-forward/Fast-reverse*
<b>▶</b>	Playback
<b>  </b>	Pause

\* This function is available while an MP3 / WAV / AAC / FLAC file is being played back.



# Listening to FM/AM broadcasts

For antenna connections, see “Connecting an FM/AM antenna” (page 19).

## How to tune in

The modes for receiving FM broadcasts consists of “Auto” mode that automatically searches available broadcast stations and “Manual” mode that lets you tune in using buttons to change the frequency. The default setting is “Auto”. You can also use “Direct Tune” to tune in by entering the frequency directly.

In “Auto” mode, you cannot tune in to radio stations if the reception is not good. If this is the case, then use the “Manual” mode or “Direct Tune” to tune in.

## Listening to FM/AM broadcasts

**1** Press **TUNER** to switch the input source to “TUNER”.

[TV Screen]

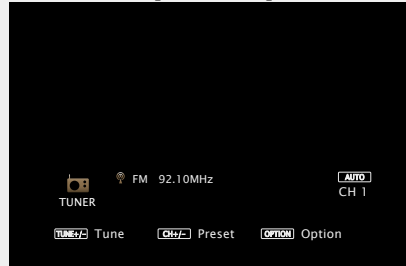

[Display of this unit]

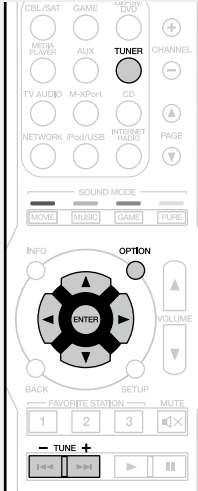
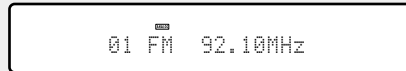

**2** Press **OPTION**.  
The option menu screen is displayed.

**3** Use  $\Delta$ / $\nabla$  to select “FM/AM”, then press **ENTER**.  
The Band screen is displayed.

[TV Screen]

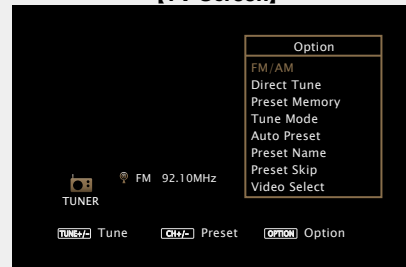

[Display of this unit]



**4** Use  $\triangleleft$ / $\triangleright$  to select “FM” or “AM”, then press **ENTER**.

[TV Screen]

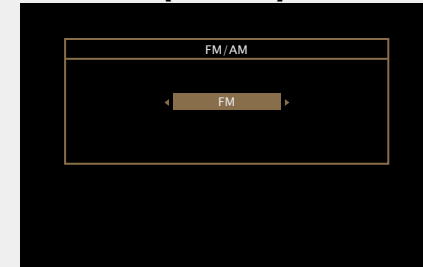

[Display of this unit]



**FM** When listening to an FM broadcast.

**AM** When listening to an AM broadcast.

**5** Press **TUNE +** or **TUNE -** to select the station you want to hear.

Scanning is performed until it finds an available radio station. When it finds a radio station, it stops the scan automatically and tunes in.



- If the desired station cannot be tuned in with auto tuning, tune it in manually.
- When tuning in stations manually, press and hold **TUNE +** or **TUNE -** to change frequencies continuously.

### ❑ Changing the screen display duration

Make this setting at “Now Playing” ([page 101](#)) in the menu. The default setting is “Always On”.

When “Auto Off” is set, the on-screen display is turned off 30 seconds after an operation.

Press  $\Delta \nabla \triangleleft \triangleright$  while the display is off to return to the original screen.

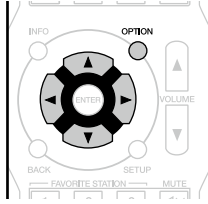

### ❑ Adding to the FAVORITE STATION button

([page 67](#))

### Operations available through the OPTION button

Press the **OPTION** button to display a menu of functions that can be used on the TV screen. Select the function you want to use from this menu. You can easily find and use the desired function.

❑ **Tuning in by entering the radio frequency (Direct Tune)** ([page 40](#))

❑ **Presetting the current broadcast station (Preset Memory)** ([page 41](#))

❑ **Changing the tuning mode (Tune Mode)** ([page 42](#))

❑ **Tuning in to radio stations and presetting them automatically (Auto Preset)** ([page 43](#))

❑ **Specify a name for the preset broadcast station (Preset Name)** ([page 44](#))

❑ **Skipping preset broadcast stations (Preset Skip)** ([page 45](#))

❑ **Displaying your desired video on the monitor during audio playback (Video Select)** ([page 69](#))

**□ Tuning in by entering the radio frequency (Direct Tune)**

You can enter the receiving frequency directly to tune in.

**1** Press **TUNER** to switch the input source to “TUNER”.

**2** Press **OPTION**.  
The option menu screen is displayed.

**3** Use  $\Delta \nabla$  to select “Direct Tune”, then press **ENTER**.  
The direct tuner screen is displayed and “\_” in the display flashes.

[TV Screen]

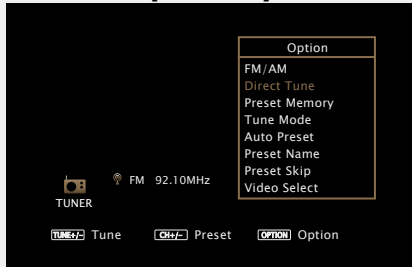

[Display of this unit]

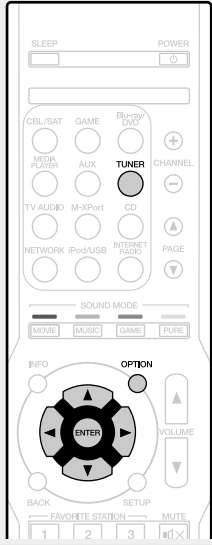

**4** Use  $\Delta \nabla$  to select a number and press  $\triangleright$ .  
The screen that lets you enter the frequency is displayed.

[TV Screen]

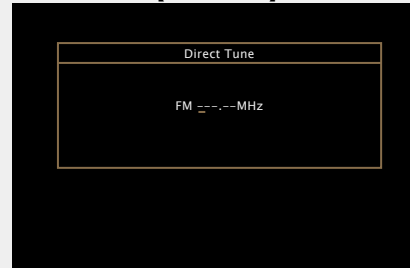

[Display of this unit]

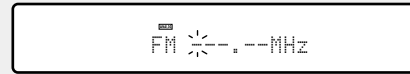
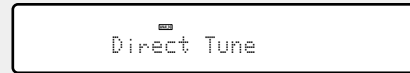

• If  $\triangleleft$  is pressed, the immediately preceding input is cancelled.

**5** Repeat step 4 and enter the frequency of the radio station you want to hear.

**6** When setting is completed, press **ENTER**.  
The preset frequency is tuned in.

### ❑ Presetting the current broadcast station (Preset Memory)

Your favorite broadcast stations can be preset so that you can tune them in easily. Up to 56 stations can be preset.

**1** Tune in the broadcast station you want to preset.

**2** Press **OPTION**.  
The option menu screen is displayed.

**3** Use  $\Delta \nabla$  to select “Preset Memory”, then press **ENTER**.  
The list of already preset channels is displayed.

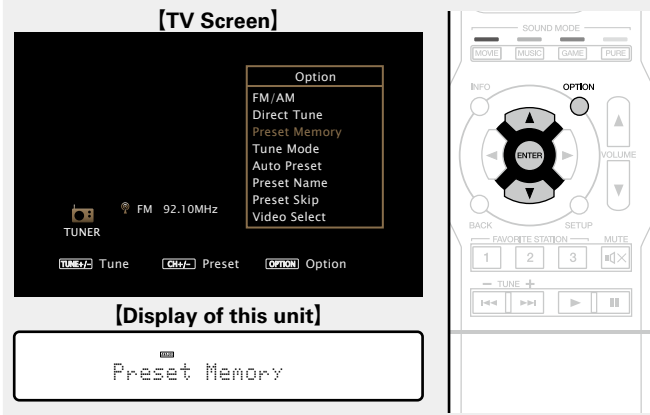

**4** Use  $\Delta \nabla$  to select the channel you want to preset, then press **ENTER**.

The current broadcast station that is preset.

- To preset other stations, repeat steps 1 to 4.

[TV Screen]

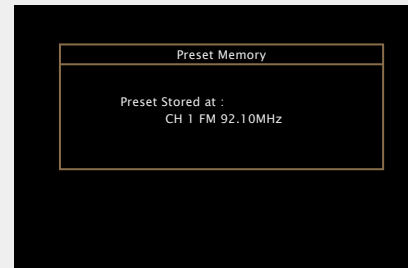
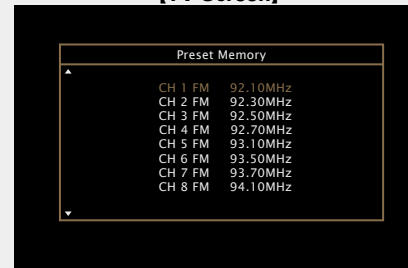

[Display of this unit]

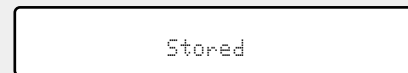
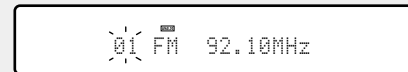

The channel numbers of broadcast stations set as “Preset Skip” (page 45) are grayed out, but these stations can be preset.

When grayed out channel numbers are preset, these are highlighted and the “Preset Skip” setting changes to “On”.

Channel	Default settings
1 – 8	92.10 / 92.30 / 92.50 / 92.70 / 93.10 / 93.50 / 93.70 / 94.10 MHz
9 – 16	94.30 / 94.50 / 94.70 / 94.90 / 95.10 / 95.30 / 95.50 / 95.70 MHz
17 – 24	98.10 / 98.30 / 98.50 / 98.70 / 98.90 / 99.10 / 100.10 / 100.30 MHz
25 – 32	100.50 / 100.70 / 100.90 / 101.10 / 101.30 / 101.50 / 101.70 / 101.90 MHz
33 – 40	103.10 / 103.30 / 103.50 / 103.70 / 103.90 / 104.10 / 104.30 / 104.50 MHz
41 – 48	104.70 / 104.90 / 105.10 / 105.30 / 105.50 / 105.70 / 105.9 / 106.10 MHz
49 – 56	106.30 / 106.50 / 106.70 / 106.90 / 107.10 / 107.30 / 107.50 / 107.90 MHz

### Listening to preset stations

Use **CHANNEL +, -** to select the desired preset channel.

[Display of this unit]

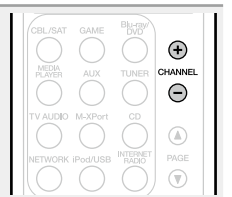
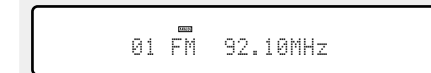

You can also select preset broadcast stations by pressing **PRESET CH +** or **PRESET CH -** on the main unit.

### □ Changing the tuning mode (Tune Mode)

You can change the mode for tuning into FM broadcasts. If you cannot tune in automatically with “Auto” mode, then change the mode to “Manual” and tune in manually.

**1** Press **TUNER** to switch the input source to “TUNER”.

**2** Press **OPTION**.  
The option menu screen is displayed.

**3** Use  $\Delta$ / $\nabla$  to select “Tune Mode”, then press **ENTER**.

[TV Screen]

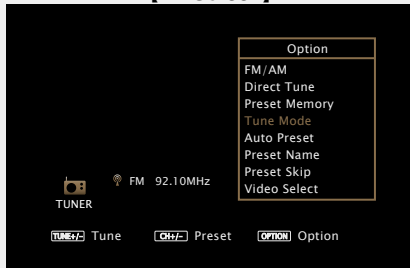

[Display of this unit]

Tune Mode

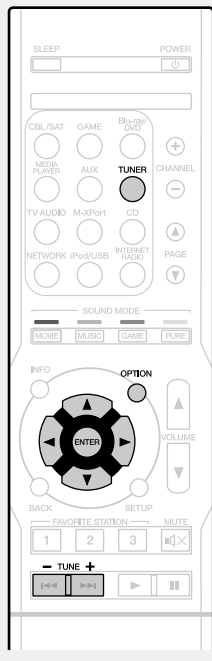

**4** Use  $\triangleleft$ / $\triangleright$  to select tuning mode, then press **ENTER**.

[TV Screen]

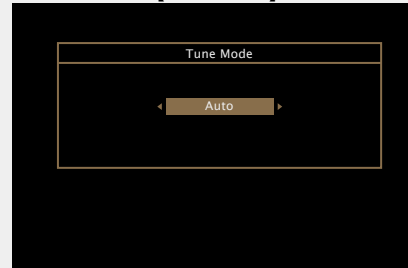

[Display of this unit]

Mode : Auto

**Auto** Automatically tune to the station.

**Manual** Manually tune to the station.



When tuning in stations manually, press and hold **TUNE +** or **TUNE -** to change frequencies continuously.

**□ Tuning in to radio stations and presetting them automatically (Auto Preset)**

Up to 56 stations can be preset.

If "Auto Preset" is performed after performing "Preset Memory", the "Preset Memory" settings will be overwritten.

**1** Press **TUNER** to switch the input source to "TUNER".

**2** Press **OPTION**.  
The option menu screen is displayed.

**3** Use  $\Delta$ / $\nabla$  to select "Auto Preset", then press **ENTER**.

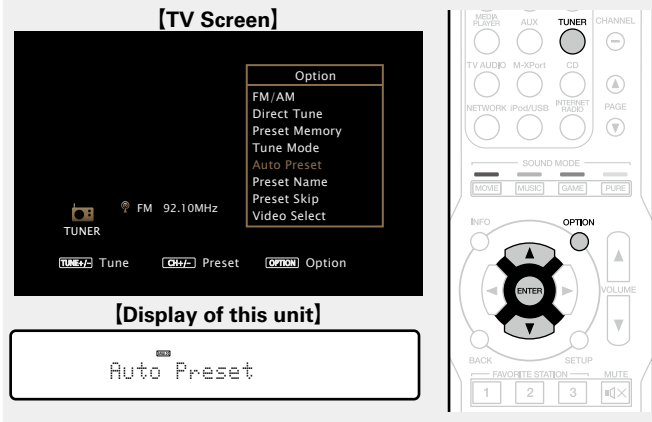

**4** Press **ENTER**.  
The unit starts to tune in to radio stations automatically and preset them.

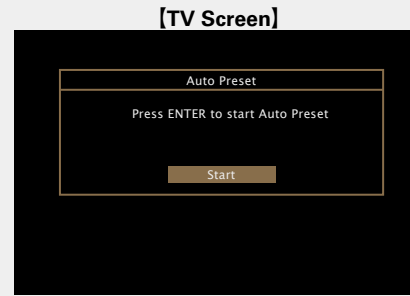

- When presetting is completed, "Completed" is displayed for about 5 seconds and the option menu screen turns off.

**Specify a name for the preset broadcast station (Preset Name)**

You can set the name to the preset broadcast station or change it. Up to eight characters can be input.

**1** Press **TUNER** to switch the input source to “TUNER”.

**2** Press **OPTION**.  
The option menu screen is displayed.

**3** Use  $\Delta \nabla$  to select “Preset Name”, then press **ENTER**.  
The Preset Name screen is displayed.

[TV Screen]

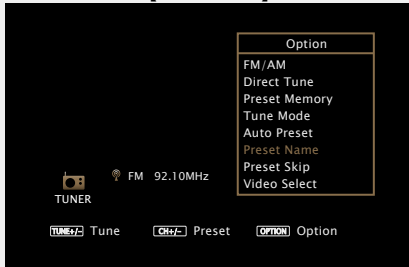

[Display of this unit]

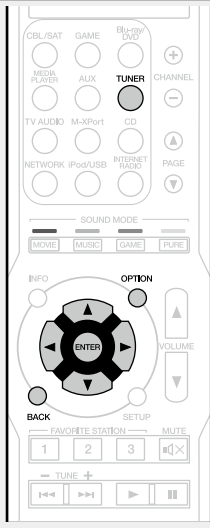
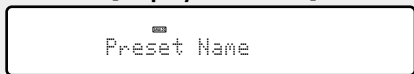

**4** Use  $\triangleleft \triangleright$  to select the group of the broadcast station you want to name then press **ENTER**.

The screen that lets you edit the preset name is displayed.

- Each time  $\triangleleft \triangleright$  is pressed, the setting is changed as shown below.

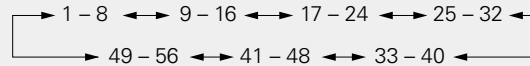

[TV Screen]

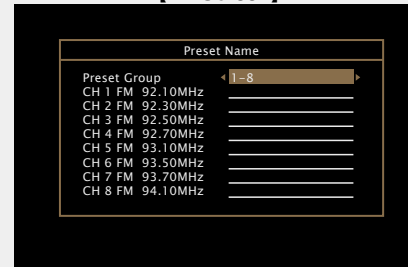

[Display of this unit]



**5** Use  $\Delta \nabla$  to select the broadcast station you want to name, then press **ENTER**.

[TV Screen]



[Display of this unit]

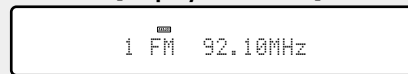

**6** Use  $\Delta \nabla$  to select a name label, then press **ENTER**.

The screen that lets you edit the preset name is displayed.

- If you select “Set Defaults”, then the unit returns to displaying the frequency.

**7** Enter the characters, then press **OK**.

- For character input, see [page 92](#).

**8** Press **BACK** twice.

The display returns to the playback screen.

### ❑ Skipping preset broadcast stations (Preset Skip)

You can set in advance, the stations you do not want to be displayed when tuning in, by groups or by stations.

The preset skip setting is useful when tuning in, because only your favorite stations are displayed.

**1** Press **TUNER** to switch the input source to “TUNER”.

**2** Press **OPTION**.  
The option menu screen is displayed.

**3** Use  $\Delta \nabla$  to select “Preset Skip”, then press **ENTER**.  
The Preset Skip screen is displayed.

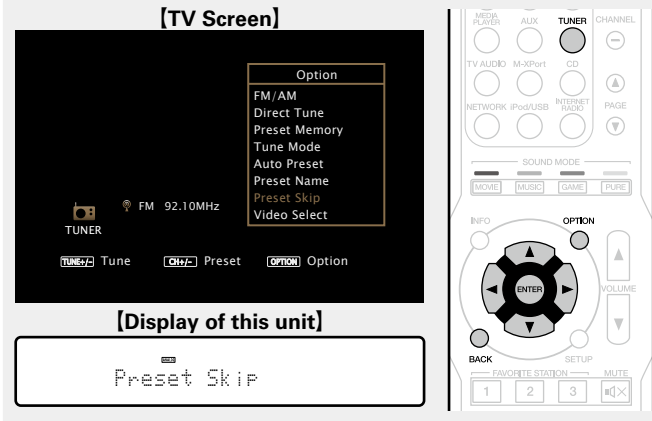

### 4-1 [To set the stations you want to skip by groups]

① Use  $\triangleleft \triangleright$  to select the group of broadcast stations you want to skip.

- Each time  $\triangleleft \triangleright$  is pressed, the setting is changed as shown below.

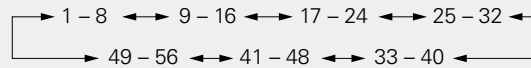

② Press  $\Delta$  to select “Set No.\* - \* to Skip”, then press **ENTER**.

All broadcast stations in the group “\* - \*” you selected are not displayed.

(\* are the selected group numbers)

③ Press **BACK**.

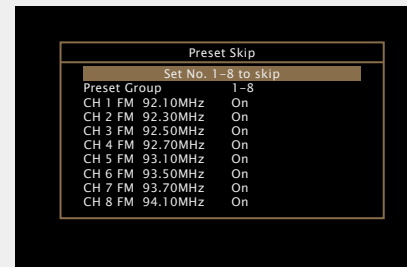
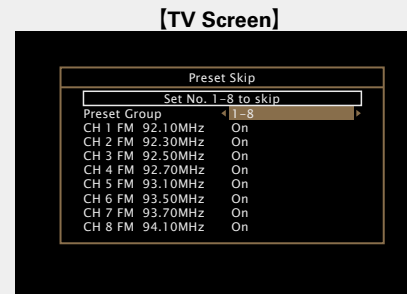

**[Display of this unit]**

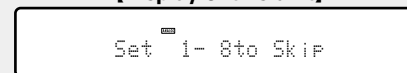

### 4-2 [To set the stations you want to skip by stations]

① Use  $\triangleleft \triangleright$  to select the group of broadcast stations you want to skip.

- Each time  $\triangleleft \triangleright$  is pressed, the setting is changed as shown below.

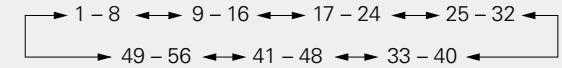

② Use  $\Delta \nabla$  to select the broadcast station you want to skip.

③ Use  $\triangleleft \triangleright$  to select “Skip”.  
The station you selected is not displayed.

④ Press **BACK**.

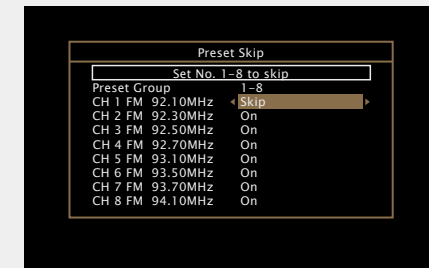
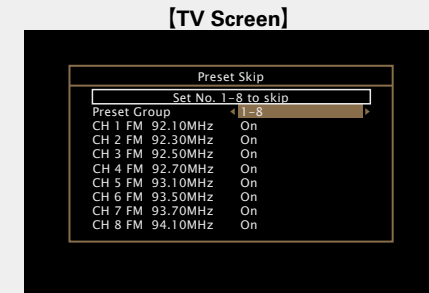

**[Display of this unit]**

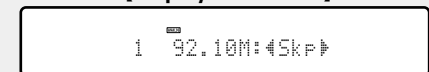



### ❑ Cancelling preset skip

**1** While the Preset Skip screen is displayed, use ◀ ▶ to select a group containing a broadcast station to cancel the skip for.

**2** Use △ ▽ to select a broadcast station to cancel the skip for.

[TV Screen]

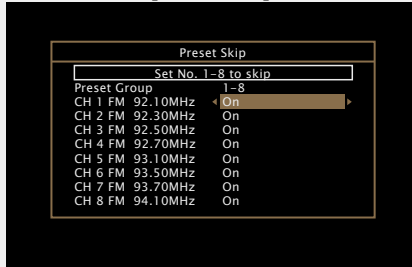

[Display of this unit]

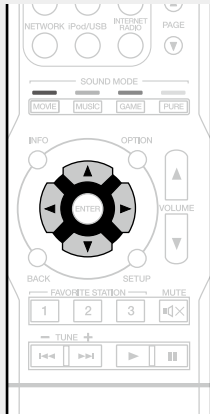
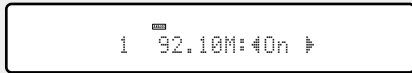

**3** Use ◀ ▶ to select “On”.  
The skip is cancelled.

**NOTE**

You cannot cancel the skip for each group.

### ❑ Tuner operation buttons

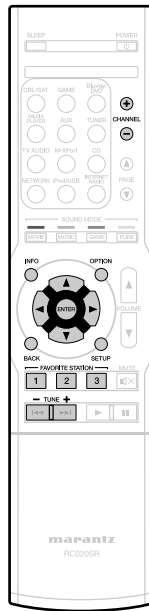

Operation buttons	Function
<b>CHANNEL +, -</b>	Preset channel selection
<b>INFO</b>	Display of information such as the source name, volume, and sound mode name
<b>OPTION</b>	FM/AM switching Direct frequency tuning / Preset Memory / Switch tuning modes / Auto Preset / Preset Name / Preset Skip / Video Select
◀ ▽ ▶ ▷	Cursor operation
<b>ENTER</b>	Enter
<b>BACK</b>	Return
<b>SETUP</b>	Setup menu
<b>FAVORITE STATION 1 - 3</b>	Call up favorite stations
<b>FAVORITE STATION 1 - 3 (Press and hold)</b>	Add to the favorite stations
<b>TUNE +, -</b>	Tuning (up/down)

# Network content

## Listening to Internet Radio

Internet Radio refers to radio broadcasts distributed over the Internet. Internet Radio stations from around the world can be received.

### Important information

The broadcast station types and specifications supported by this unit for playback are as follows.

#### [Playable broadcast station types]

Supported file types	Internet Radio
<b>WMA</b> (Windows Media Audio)	✓
<b>MP3</b> (MPEG-1 Audio Layer-3)	✓

#### [Playable broadcast station specifications]

	Sampling frequency	Bit rate	Extension
<b>WMA</b> (Windows Media Audio)	32/44.1/48 kHz	48 – 192 kbps	.wma
<b>MP3</b> (MPEG-1 Audio Layer-3)	32/44.1/48 kHz	32 – 320 kbps	.mp3

## Listening to Internet Radio

### 1 Prepare for playback.

- ① Check the network environment, then turn on this unit's power (see [page 21](#) "Connecting to a home network (LAN)").
- ② If settings are required, make the "Settings" (see [page 112](#)).

### 2 Press NETWORK.

- You can also press **INTERNET RADIO** to select the input source "Internet Radio" directly.

### 3 Use $\Delta$ $\nabla$ $\triangleleft$ $\triangleright$ to select "Internet Radio", then press ENTER.

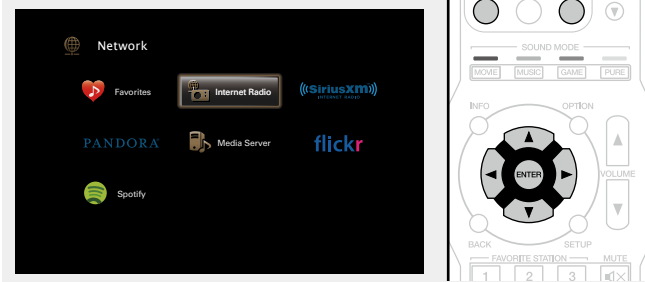

### 4 Use $\Delta$ $\nabla$ to select the item you want to play, then press ENTER or $\triangleright$ .



- \*\*\*\*\***  
(Country name) Displays typical Internet Radio stations your country.
- Search Stations** Displays all Internet Radio stations that this unit can tune in to.
- Search Podcasts** Displays Internet Radio stations in the podcasts that this unit can tune in to.
- Recommended Stations** Displays recommended Internet Radio stations.
- radiomarantz.com** Displays Internet Radio stations added to favorites in vTuner. For instructions on how to add to favorites in vTuner, see "Using vTuner to add Internet Radio stations to favorites" (see [page 49](#)).
- Recently Played** Displays recently played Internet Radio stations. Up to 20 stations stored in "Recently Played".
- Search by Keyword** Displays Internet Radio stations searched by keyword. For character input, see [page 92](#).

### 5 Repeat step 4 until the station list is displayed.

The station list is displayed.

### 6 Use $\Delta$ $\nabla$ to select the station, then press ENTER or $\triangleright$ .

Playback starts once buffering reaches "100%".

### ❑ Adjusting the sound quality (M-DAX)

Make this setting at "M-DAX" ([page 96](#)) in the menu.

You can use the M-DAX function to improve the fidelity of compressed audio sources such as content from Internet Radio stations. The M-DAX has selectable levels of restoration. The default setting is "Off".

### ❑ Switching the screen display

Press **STATUS** on the main unit.

The display switches between track title and radio station name etc. each time the button is pressed.

### ❑ Going back to the previous screen

Press ◀ or **BACK**.

### ❑ Changing the screen display duration

Make this setting at "Now Playing" ([page 101](#)) in the menu. The default setting is "Always On".

When "Auto Off" is set, the on-screen display is turned off 30 seconds after an operation.

Press △▽◀▶ while the display is off to return to the original screen.



- There are many Internet Radio stations on the Internet, and the quality of the programs they broadcast as well as the bit rate of the tracks varies widely. Generally, the higher the bit rate, the higher the sound quality, but depending on the communication lines and server traffic, the music or audio signals being streamed may be interrupted. Inversely, lower bit rates mean a lower sound quality but less tendency for the sound to be interrupted.
- "Radio station server full" or "Connection down" is displayed if the station is busy or not broadcasting.
- On this unit, folder and file names can be displayed as titles. Any characters that cannot be displayed are replaced with "." (period).

#### NOTE

The radio station database service may be suspended or be otherwise unavailable without notice.

### Operations available through the OPTION button

Press the **OPTION** button to display a menu of functions that can be used on the TV screen. Select the function you want to use from this menu. You can easily find and use the desired function.

❑ **Searching content with keywords (Text Search)** ([page 65](#))

❑ **Add to favorites from the Option menu (Save to Favorite)** ([page 67](#))

❑ **Playing back music and a favorite picture at the same time (Slideshow)** ([page 68](#))

❑ **Displaying your desired video on the monitor during audio playback (Video Select)** ([page 69](#))

### ❑ Playing the last played Internet Radio station

This unit memorizes the last played Internet Radio station. If you press **INTERNET RADIO** to switch to the Internet Radio function from another input source, the last Internet Radio station you listened to is played.

#### Press INTERNET RADIO.

The source switches to "Internet Radio" and the last played radio station plays.



## ❑ Using vTuner to add Internet Radio stations to favorites

There are many Internet Radio stations in the world, and this unit can tune into these stations. But finding the radio station you want to hear may be difficult, because there are too many stations. If this is the case, then please use vTuner, an Internet Radio station search website specifically designed for this unit. You can use your PC to search Internet Radio stations and add them as your favorites. This unit can play radio stations added to vTuner.

### 1 Check the MAC address of this unit (page 111).

The screen that lets you edit the preset name is displayed.  
MAC address:

- The MAC address is necessary when you create an account for vTuner.

### 2 Use your PC to access the vTuner website (<http://www.radiomarantz.com>).

The vTuner login screen is displayed.

### 3 Enter the MAC address of this unit, then click “Go”.

The account creation screen is displayed.

### 4 Enter your E-mail address and a password of your choice.

The account is registered and you can now log in.

### 5 Enter your account information (E-mail address and password) and log in.

The top menu of vTuner is displayed.

### 6 Select the search criteria (genre, region, language, etc.) of your choice.

The list of radio stations matching the criteria is displayed.

- You can also enter a keyword to search for a station you want to hear.

### 7 Select the radio station of your choice from the list, and then click the Add to Favorites icon.

The screen that lets you create a favorite group is displayed.

### 8 Enter the name of the favorite group, then click “Go”.

A new favorite group that includes the selected radio station is created.

- Internet Radio stations added to favorites in vTuner can be played from “radiomarantz.com” (page 47) with this unit.

## ❑ Internet Radio operation buttons

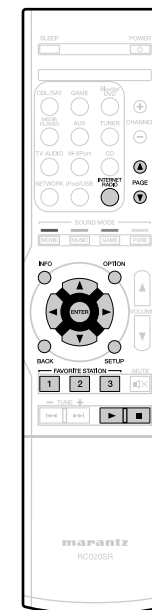

Operation buttons	Function
<b>INTERNET RADIO</b>	Last played Internet Radio station
<b>PAGE ▲▼</b>	Page search
<b>INFO</b>	Display of information such as the source name, volume, and sound mode name
<b>OPTION</b>	Text Search / Save to Favorite / Slideshow / Video Select
△▽◀▶	Cursor operation
<b>ENTER</b> (Press and release)	Enter
<b>ENTER</b> (Press and hold)	Stop
<b>BACK</b>	Return
<b>SETUP</b>	Setup menu
<b>FAVORITE STATION 1 – 3</b>	Call up favorite stations
<b>FAVORITE STATION 1 – 3</b> (Press and hold)	Add to the favorite stations
▶	Playback
⏸	Stop

## Playing back files stored on a PC and NAS

This unit can play back music files and playlists (m3u, wpl) stored on a PC and on Network Attached Storage (NAS) that supports DLNA.

### Important information

- The network audio playback function of this unit connects to the server using technologies shown below.
  - Windows Media Player Network Sharing Service
  - Windows Media DRM10
- File types that this unit can play back and specifications are shown below.

#### [Supported file types]

Supported file types	Media Server *1
<b>WMA</b> (Windows Media Audio)	✓
<b>MP3</b> (MPEG-1 Audio Layer-3)	✓
<b>WAV</b>	✓
<b>MPEG-4 AAC</b>	✓*2
<b>FLAC</b> (Free Lossless Audio Codec)	✓
<b>JPEG</b>	✓
<b>ALAC</b> (Apple Lossless Audio Codec)	✓

A server or server software compatible with distribution in the corresponding formats is required to play music files via a network.

\*1 Media Server

- This unit is compatible with MP3 ID3-Tag (Ver. 2) standard.
- This unit can show the artwork that was embedded by using MP3 ID3-Tag Ver. 2.3 or 2.4.
- This unit is compatible with WMA META tags.
- If the image size (pixels) of an album artwork exceeds 500 × 500 (WMA/MP3/WAV/FLAC) or 349 × 349 (MPEG-4 AAC), then music may not be played back properly.
- WAV format Quantization bit length: 16 or 24 bits.
- FLAC format Quantization bit length: 16 or 24 bits.

\*2 Only files that are not protected by copyright can be played on this unit.

Content downloaded from pay sites on the Internet are copyright protected. Also, files encoded in WMA format when ripped from a CD, etc. on a computer may be copyright protected, depending on the computer's settings.

#### NOTE

File types that this unit does not support are not displayed.

#### [Specifications of supported files]

	Sampling frequency	Bit rate	Extension
<b>WMA</b> (Windows Media Audio)	32/44.1/48 kHz	48 – 192 kbps	.wma
<b>MP3</b> (MPEG-1 Audio Layer-3)	32/44.1/48 kHz	32 – 320 kbps	.mp3
<b>WAV</b>	32/44.1/48/88.2/96/ 176.4/192 kHz	–	.wav
<b>MPEG-4 AAC</b>	32/44.1/48 kHz	16 – 320 kbps	.aac/ .m4a/ .mp4
<b>FLAC</b> (Free Lossless Audio Codec)	32/44.1/48/88.2/96/ 176.4/192 kHz	–	.flac
<b>ALAC</b> (Apple Lossless Audio Codec)*	32/44.1/48/88.2/96 kHz	–	.m4a

\* Copyright [2012] [D&M Holdings. Inc.]

Licensed under the Apache License, Version 2.0 (the "License"); you may not use this file except in compliance with the License. You may obtain a copy of the License at <http://www.apache.org/licenses/LICENSE-2.0>

## Applying media sharing settings

Here, we apply the settings to share music files stored on a PC and NAS on the network.

### Sharing media stored in PC

If you are using a Media Server, be sure to apply this setting first.

### When using Windows Media Player 12 (Windows 7 / Windows 8)

#### NOTE

Perform this procedure after changing the control panel display to "Category".

- 1** In the PC's "Control Panel", select "Network and Internet" - "Choose homegroup and sharing options".
- 2** Select the "Stream my pictures, music, and videos to all devices on my home network" check box and select "Choose media streaming options".
- 3** Select "Allowed" in the drop-down list for "NR1504".
- 4** Select "Allowed" in the drop-down list for "Media programs on this PC and remote connections...".
- 5** Click "OK" to finish.

### When using Windows Media Player 11

- 1** Start up Windows Media Player 11 on the PC.
- 2** Select "Media Sharing" in the "Library".
- 3** Click the "Share my media" check box, select "NR1504", and then click "Allow".
- 4** As you did in step 3, select the icon of the device (other PCs and mobile devices) you want to use as a media controller, and then click "Allow".
- 5** Click "OK" to finish.

### Sharing media stored in NAS

Change settings on the NAS to allow this unit and other devices (PCs and mobile devices) used as media controllers to access the NAS. For details, see the owner's manual that came with the NAS.

## Playing back files stored on a PC and NAS

Use this procedure to play music files, image files or playlists.

### 1 Prepare for playback.

- ① Check the network environment, then turn on this unit's power (☞ [page 21](#) "Connecting to a home network (LAN)").
- ② If settings are required, make the "Settings" (☞ [page 112](#)).
- ③ Prepare the computer (☞ Computer's operating instructions).

### 2 Press NETWORK.

- You can also press **MEDIA SERVER** to select the input source "Media Server" directly.

### 3 Use $\Delta$ $\nabla$ $\triangleleft$ $\triangleright$ to select "Media Server", then press ENTER.

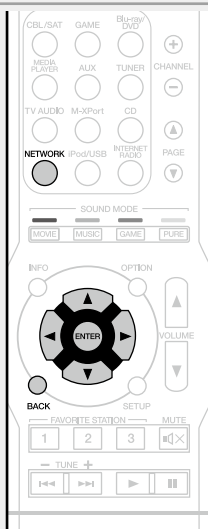
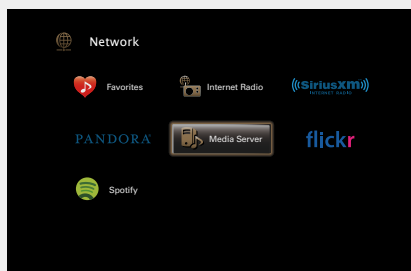

### 4 Use $\Delta$ $\nabla$ to select the server including the file to be played, then press ENTER or $\triangleright$ .

### 5 Use $\Delta$ $\nabla$ to select the search item or folder, then press ENTER or $\triangleright$ .

### 6 Repeat step 4 until the file is displayed.

### 7 Use $\Delta$ $\nabla$ to select the file, then press ENTER or $\triangleright$ . Playback starts once buffering reaches "100%".

#### ☐ Adjusting the sound quality (M-DAX)

Make this setting at "M-DAX" (☞ [page 96](#)) in the menu. You can use the M-DAX function to improve the fidelity of compressed audio sources such as MP3 files. The M-DAX has selectable levels of restoration. The default setting is "Off".

#### ☐ Switching the screen display

Press **STATUS** on the main unit. The display switches between track title, artist name, and album title each time the button is pressed.

#### ☐ Going back to the previous screen

Press  $\triangleleft$  or **BACK**.

#### ☐ Changing the screen display duration

Make this setting at "Now Playing" (☞ [page 101](#)) in the menu. The default setting is "Always On". When "Auto Off" is set, the on-screen display is turned off 30 seconds after an operation. Press  $\Delta$   $\nabla$   $\triangleleft$   $\triangleright$  while the display is off to return to the original screen.



- When a WMA (Windows Media Audio), MP3 or MPEG-4 AAC file includes album art data, the album art can be displayed while the music files are playing.
- If you use Ver.11 or later of Windows Media Player, the album art for WMA files can be displayed.
- WMA Lossless files can be played when using a server supporting transcoding, such as Windows Media Player Ver. 11 or later.

#### NOTE

- When playing back music files with your PC or NAS connected through wireless LAN, audio may be interrupted depending on your wireless LAN environment. In this case, play back music files with your PC or NAS connected through wired LAN.
- Depending on the size of the still picture (JPEG) file, some time may be required for the file to be displayed.
- The order in which the tracks/files are displayed depends on the server specifications. If the tracks/files are not displayed in alphabetical order due to the server specifications, searching by the first letter may not work properly.

### Operations available through the OPTION button

Press the **OPTION** button to display a menu of functions that can be used on the TV screen. Select the function you want to use from this menu. You can easily find and use the desired function.

- Searching content with keywords (Text Search)** (👉 [page 65](#))
- Performing repeat playback (Repeat)** (👉 [page 65](#))
- Performing random playback (Random)** (👉 [page 66](#))
- Playing back still images in sequential order (Slideshow Time)** (👉 [page 68](#))
- Add to favorites from the Option menu (Save to Favorite)** (👉 [page 67](#))
- Playing back music and a favorite picture at the same time (Slideshow)** (👉 [page 68](#))
- Displaying your desired video on the monitor during audio playback (Video Select)** (👉 [page 69](#))

### Media Server operation buttons

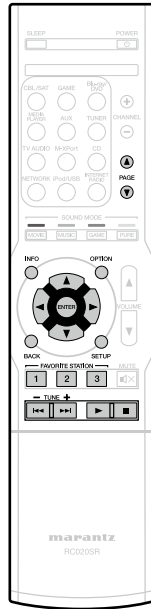

Operation buttons	Function
<b>PAGE ▲▼</b>	Page search
<b>INFO</b>	Display of information such as the source name, volume, and sound mode name
<b>OPTION</b>	Text Search / Repeat playback / Random playback / Slideshow Time / Save to Favorite / Slideshow / Video Select
△▼◀▶	Cursor operation / Next/Previous (△▼) / Fast-forward/Fast-reverse (Press and hold, △▼)*
<b>ENTER</b> (Press and release)	Enter
<b>ENTER</b> (Press and hold)	Stop
<b>BACK</b>	Return
<b>SETUP</b>	Setup menu
<b>FAVORITE STATION 1 – 3</b>	Add/call up favorite stations
<b>FAVORITE STATION 1 – 3</b> (Press and hold)	Add to the favorite stations
<b>◀▶▶▶</b> (Press and release)	Next/Previous
<b>◀▶▶▶</b> (Press and hold)	Fast-forward/Fast-reverse*
<b>▶</b>	Playback
<b>  </b>	Pause

\* This function is available while an MP3 / WAV / AAC / FLAC file is being played back.



## Using online services

This unit supports playback of the online services shown below.

### ❑ About Flickr (👉 page 55)

Flickr is an online photograph sharing service that started in 2004. You can use this unit to view photographs that have been made public by Flickr users. You do not need an account to use Flickr. To view photographs that you recorded yourself, you need an account in order to upload these photographs to the Flickr server. For details, see the Flickr homepage.  
<http://www.flickr.com/>

### ❑ About Pandora® (👉 page 57)

Pandora is an automated music recommendation and Internet Radio service created by the Music Genome Project. To listen to Pandora you will need a free Pandora account. If you do not have a Pandora account, you can create one at [www.pandora.com](http://www.pandora.com) or from the Pandora smartphone application. It is necessary to associate this machine with a Pandora account by visiting <http://www.pandora.com/marantz> from your PC.

### ❑ About SiriusXM (👉 page 61)

Enjoy anywhere access to the unparalleled content of SiriusXM. Whether on your computer, smartphone, tablet, Lynx Portable Enjoy anywhere access to the unparalleled content of SiriusXM. Whether on your computer, smartphone, tablet, Lynx Portable Radio, or compatible Internet-connected device, you don't need to be in your vehicle to enjoy SiriusXM. For details, see the SiriusXM homepage.  
<http://www.siriusxm.com>

### ❑ About Spotify (👉 page 63)

Introduce your Marantz to a whole new world of music. With Spotify, you can enjoy instant access to millions of songs. A Spotify Premium subscription is required. For details, see the Spotify homepage.  
<http://www.spotify.com>

## Viewing photographs on the Flickr site

You can view photographs shared by particular users, or all of the photographs shared on Flickr.

### Viewing photographs shared by particular users

#### 1 Prepare for playback.

- ① Check the network environment, then turn on this unit's power (☞ [page 21](#) "Connecting to a home network (LAN)").
- ② If settings are required, make the "Settings" (☞ [page 112](#)).

#### 2 Press NETWORK.

#### 3 Use $\Delta \nabla \triangleleft \triangleright$ to select "Flickr", then press ENTER.

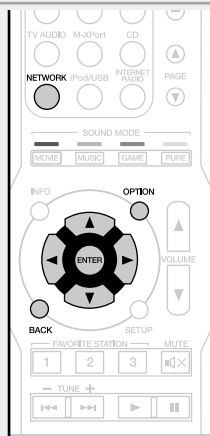
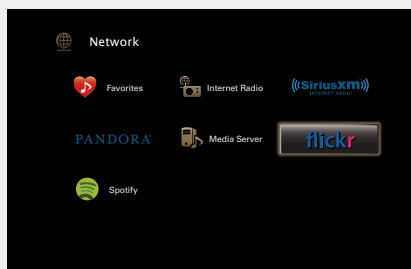

#### 4 Use $\Delta \nabla$ to select "Add Flickr Contact", then press ENTER or $\triangleright$ .

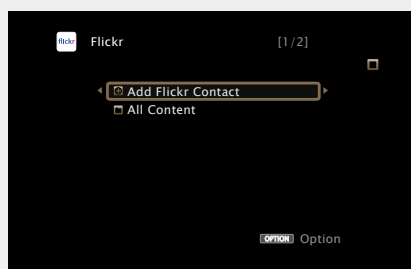

#### 5 In "Contact", add the screen name (user name you want to view) you want to add.

- For character input, see [page 92](#).

#### 6 After inputting the "Contact", press **OK**.

The screen name is added to "Contact", and the screen name you entered in Step 5 is displayed on the top screen of Flickr.

- If you enter a screen name that does not exist, "The Flickr Contact you entered could not be found" is displayed. Check and enter the correct screen name.

#### 7 Use $\Delta \nabla$ to select the folder, and then press ENTER or $\triangleright$ .

<b>Favorites</b>	Displays the favorite photographs of the specified user.
<b>Photostream</b>	Displays a list of shared photographs.
<b>PhotoSets</b>	Displays the folder (photograph album) list.
<b>Contacts</b>	Displays the screen name used by the specified user in Contacts.
<b>Remove this Contact</b>	Deletes a user from Flickr Contact.
<b>Add this Contact</b>	Adds a user from Flickr Contact.

#### 8 Use $\Delta \nabla$ to select the file, and then press ENTER or $\triangleright$ .

The selected file is displayed.

#### Going back to the previous screen

Press  $\triangleleft$  or **BACK**.

#### Operations available through the OPTION button

Press the **OPTION** button to display a menu of functions that can be used on the TV screen. Select the function you want to use from this menu. You can easily find and use the desired function.

#### Playing back still images in sequential order (Slideshow Time) (☞ [page 68](#))

#### Displaying your desired video on the monitor during audio playback (Video Select) (☞ [page 69](#))

### ❑ Viewing all photographs on Flickr

**1** Use  $\Delta \nabla$  to select “All Content”, then press **ENTER** or  $\triangleright$ .

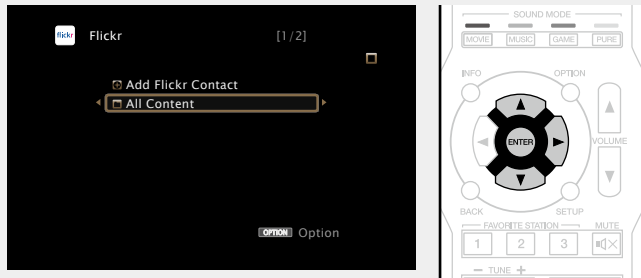

**2** Use  $\Delta \nabla$  to select the folder, and then press **ENTER** or  $\triangleright$ .

**Interestingness** Displays photographs that are popular from the number of user comments or number of times they are added as favorites.

**Recent** Displays the most recently added photographs.

**Search by text** Search for photographs by keyword.

**3** Use  $\Delta \nabla$  to select the file, and then press **ENTER** or  $\triangleright$ .  
The selected file is displayed.

**NOTE**

Depending on the file format, some photographs may not be viewable.

### ❑ Flickr operation buttons

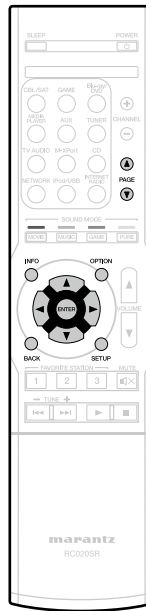

Operation buttons	Function
<b>PAGE</b> $\Delta \nabla$	Page search
<b>INFO</b>	Display of information such as the source name, volume, and sound mode name
<b>OPTION</b>	Slideshow Time / Video Select
$\Delta \nabla \triangleleft \triangleright$	Cursor operation / Next/Previous ( $\Delta \nabla$ )
<b>ENTER</b> (Press and release)	Enter
<b>ENTER</b> (Press and hold)	Stop
<b>BACK</b>	Return
<b>SETUP</b>	Setup menu

## Listening to Pandora®

### 1 Prepare for playback.

- ① Check the network environment, then turn on this unit's power (see [page 21](#) "Connecting to a home network (LAN)").
- ② If settings are required, make the "Settings" (see [page 112](#)).
- ③ Complete step 4 and obtain a Pandora account.
  - If you already have a Pandora account, you do not need to obtain a new account. Use your existing Pandora account.

### 2 Press NETWORK.

### 3 Use $\Delta \nabla \triangleleft \triangleright$ to select "Pandora", then press ENTER.

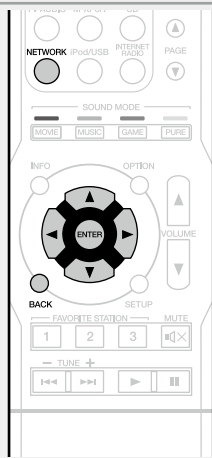
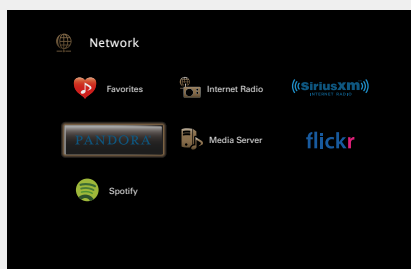

### 4 If you have a Pandora account, use $\Delta \nabla$ to select "I have a Pandora account", then press ENTER or $\triangleright$ .

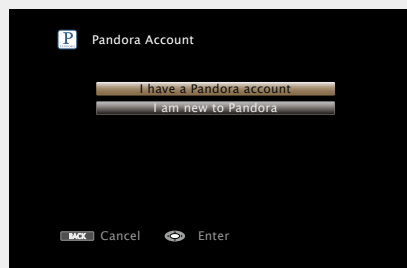

- If you do not have a Pandora account, press  $\nabla$  to select "I am new to Pandora". The URL of Pandora and activation code are displayed. Access the Pandora web page from your PC and register the displayed activation code and account information. Then press ENTER.

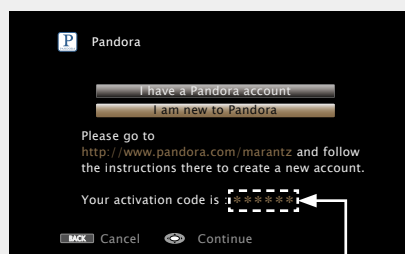

This is an identification code required to register your purchased product to the Pandora service.  
This code is used to obtain your account.

### 5 Input "Email address" and "Password".

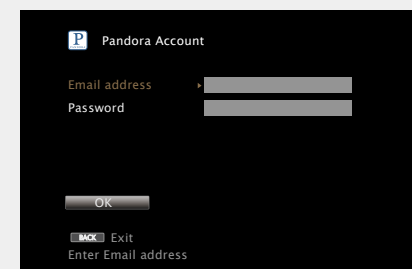

- For character input, see [page 92](#).

### 6 After inputting the "Email address" and "Password", select "OK", then press ENTER.

If the "Email address" and "Password" match, the top menu for Pandora is displayed.

#### NOTE

Press **BACK** to cancel the input. When "Cancel Input?" is displayed, select "Yes", then press **ENTER**.

## Operations available through the OPTION button

Press the **OPTION** button to display a menu of functions that can be used on the TV screen. Select the function you want to use from this menu. You can easily find and use the desired function.

□ **Displaying your desired video on the monitor during audio playback (Video Select)** (see [page 69](#))

## □ Creating a new station

You can create up to 100 radio stations.

**1** Use  $\Delta$ / $\nabla$  to select “New Station”, then press **ENTER** or  $\triangleright$ .

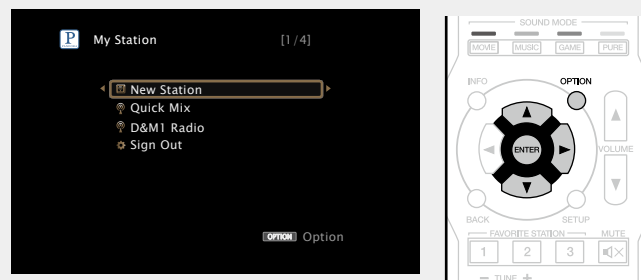

**2** Input a track or artist name, then press **OK**.



• For character input, see [page 92](#).

**3** Use  $\Delta$ / $\nabla$  to select “Search by Artist” or “Search by Track”, then press **ENTER**.

You can search and display a list by track or artist.

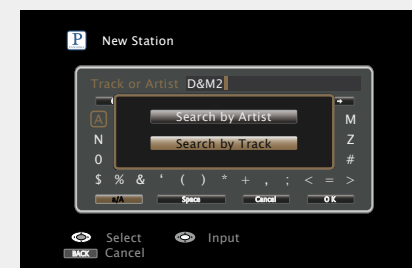

**4** Press  $\Delta$ / $\nabla$ , select a file (e.g. D&M2) from the list, and press **ENTER** or  $\triangleright$ .

“Radio” is added to the end of a filename, and your new station is created (e.g. D&M2 Radio).

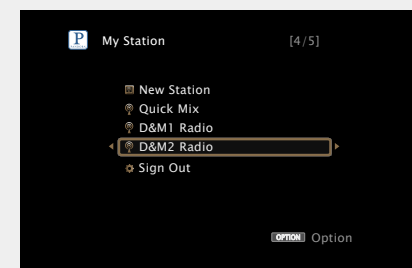

• Your new station will play music with similar qualities to the artist or track you entered.

## Listening to an existing station

Use  $\triangle$ / $\nabla$  and select the radio station (“D&M2 Radio”) that you want to listen to, and press **ENTER** or  $\triangleright$ .

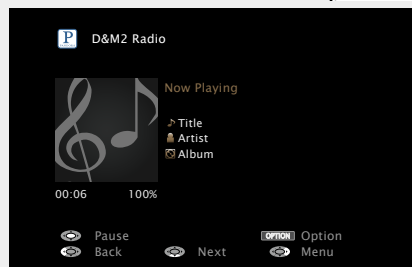
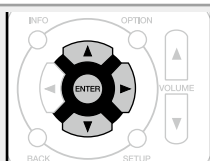

## Listening to created radio stations at random

Use  $\triangle$ / $\nabla$  to select “Quick Mix”, then press **ENTER** or  $\triangleright$ .

Created radio stations are selected at random, and tracks are streamed.

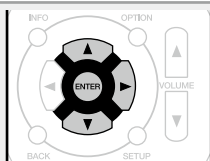

## Giving Feedback and Managing Stations

You can personalize your stations by providing feedback.

Press  $\triangleright$  while a track is playing.

The Pandora menu screen is displayed.

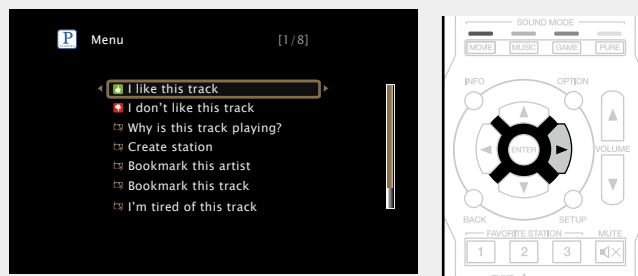

### I like this track

- Press when you like the track that is being played.
- It will return to the Play Screen. And (Thumbs up) icon is displayed. (The icon is not displayed on the next track.)

### I don't like this track

- Press when you don't like the track that is being played.
- It will return to the Play Screen. And (Thumbs down) icon is displayed. (The icon is not displayed on the next track.)

### Why is this track playing?

- Displays the reason why Pandora selected this track.

### Create station

- Creates a Station for the Track or Artist being played.

### Bookmark this artist

- Bookmarks the artist currently being played.
- You can check on a computer or iPhone etc.
- For details, see the Pandora web page.

### Bookmark this track

- Bookmarks the track currently being played.
- You can check on a computer or iPhone etc.
- For details, see the Pandora web page.

### I'm tired of this track

- Press when you don't like the track that is being played.
- The track will not be played for 1 month.

### Delete this station

- Press when you want to delete the station that is being played.

## NOTE

- You can Skip up to 6 Tracks that are being played back within 1 hour.
- You can create up to 100 Stations (radio stations).

## Sign out

Disassociate this unit from your Pandora account.

**1** Use  $\triangle$ / $\nabla$  to select “Sign Out”, then press **ENTER** or  $\triangleright$ .

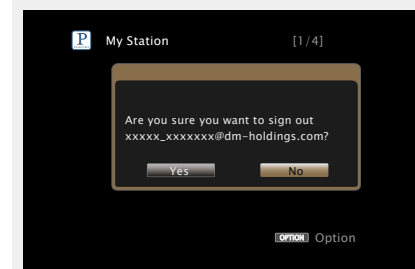

**2** When the popup menu appears, use  $\triangleleft$ / $\triangleright$  to select “Yes”, then press **ENTER**.

## □ Pandora operation buttons

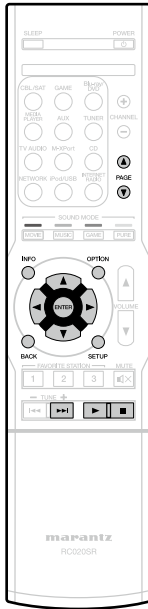

Operation buttons	Function
<b>PAGE ▲▼</b>	Page search
<b>INFO</b>	Display of information such as the source name, volume, and sound mode name
<b>OPTION</b>	Video Select
△▼◀▶	Cursor operation / Skips the current track, subject to skip limit (▼)
<b>ENTER</b> (Press and release)	Enter
<b>ENTER</b> (Press and hold)	Stop
<b>BACK</b>	Return
<b>SETUP</b>	Setup menu
▶▶	Skips the current track, subject to skip limit
▶	Playback
	Pause

## Listening to SiriusXM Internet Radio

Over 120 channels of the SiriusXM programming you love, including commercial-free music plus sports, talk, news and entertainment. Listen anywhere on your computer or smartphone.

### 1 Prepare for playback.

- ① Check the network environment, then turn on this unit's power (see [page 21](#) "Connecting to a home network (LAN)").
- ② If settings are required, make the "Settings" (see [page 112](#)).
- ③ Access the following website from your PC and obtain a SiriusXM account.  
<http://www.siriusxm.com>
  - If you already have a SiriusXM account, you do not need to obtain a new account. Select "Sign in" in step 4, and enter your existing SiriusXM account.

### 2 Press NETWORK.

### 3 Use $\Delta$ $\nabla$ $\triangleleft$ $\triangleright$ to select "SiriusXM", then press ENTER.

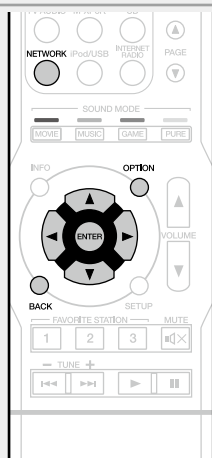
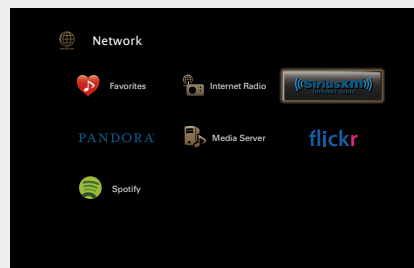

### 4 Select "Sign in", then press ENTER.

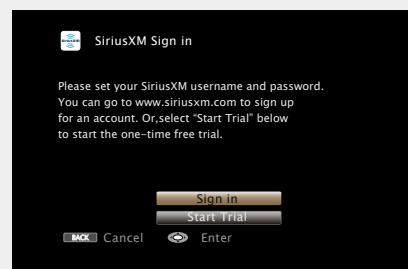

### 5 Input the "Username" and "Password".

- For character input, see [page 92](#).

### 6 Select the "Sign in", and then press ENTER.

The top menu of SiriusXM is displayed.



### 7 Use $\Delta$ $\nabla$ to select the genre, then press ENTER or $\triangleright$ .

### 8 Use $\Delta$ $\nabla$ to select the file, and then press ENTER or $\triangleright$ .

The selected file is displayed.

### ❑ Going back to the previous screen

Press  $\triangleleft$  or BACK.

### Operations available through the OPTION button

Press the **OPTION** button to display a menu of functions that can be used on the TV screen. Select the function you want to use from this menu. You can easily find and use the desired function.

### ❑ Displaying your desired video on the monitor during audio playback (Video Select) (see [page 69](#))



**❑ Sign out**

Disassociate this unit from your SiriusXM account.

**1** Use  $\Delta \nabla$  to select “Sign Out”, then press **ENTER** or  $\triangleright$ .

**2** When the popup menu appears, use  $\triangleleft \triangleright$  to select “Yes”, then press **ENTER**.



**❑ SiriusXM operation buttons**

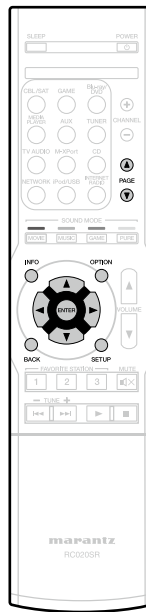

Operation buttons	Function
<b>PAGE</b> $\blacktriangle \blacktriangledown$	Page search
<b>INFO</b>	Display of information such as the source name, volume, and sound mode name
<b>OPTION</b>	Video Select
$\triangleleft \triangleright \blacktriangle \blacktriangledown$	Cursor operation
<b>ENTER</b> (Press and release)	Enter
<b>ENTER</b> (Press and hold)	Stop
<b>BACK</b>	Return
<b>SETUP</b>	Setup menu

## Listening to Spotify

Introduce your Marantz to a whole new world of music. With Spotify, you can enjoy instant access to millions of songs.

A Spotify Premium subscription is required.

For details, see the Spotify homepage.

<http://www.spotify.com>

### 1 Prepare for playback.

- Check the network environment, then turn on this unit's power (refer page 21 "Connecting to a home network (LAN)").
- If settings are required, make the "Settings" (refer page 112).
- Complete step 5 and obtain a Spotify account.
  - If you already have a Spotify account, you do not need to obtain a new account. Use your existing Spotify account.

### 2 Press NETWORK.

### 3 Use $\Delta \nabla \triangleleft \triangleright$ to select "Spotify", then press ENTER.

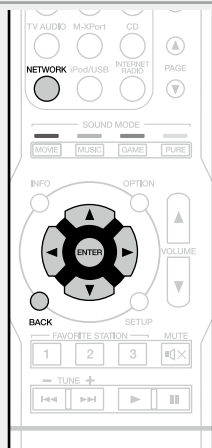
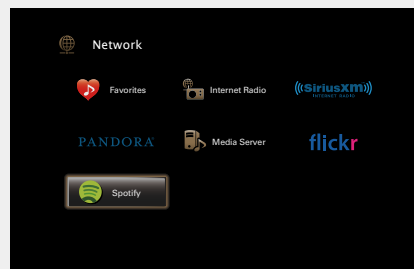

### 4 If you have a Spotify account, then press ENTER.

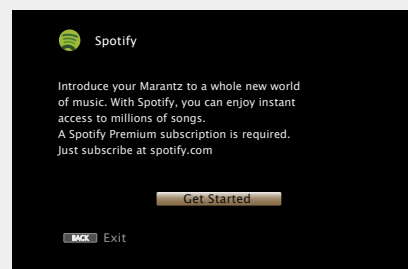

### 5 Use $\Delta \nabla \triangleright$ to enter your username and password.

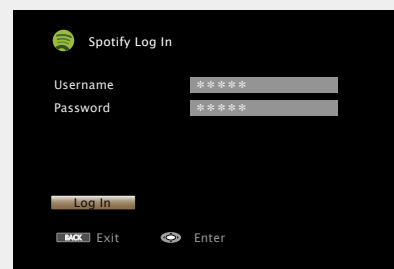

- The password should be no longer than 99 characters. For character input, see page 92.
- The types of characters that can be input are as shown below.

**[Upper case characters/Numbers/Symbols]**  
 ABCDEFGHIJKLMNOPQRSTUVWXYZ  
 ÅÄÅÄÅÄÆÇÐÈÉÊËÌÍÎÏÑÒÓÔÕÖØÙÚÛÜÝ  
 0123456789  
 ! " # \$ % & ' ( ) \* + , ; < = >

**[Lower case characters/Numbers/Symbols]**  
 abcdefghijklmnopqrstuvwxyz  
 åäååååæçðèéêëìíîïñòóôõöøùúûüýþÿ  
 0123456789  
 . @ - \_ / : ~ ? [ \ ] ^ ' { | }

- When you use  $\Delta \nabla$  while you type in, you can change uppercase characters to lowercase and vice versa.
- Press **BACK** to cancel the input. When "Cancel input?" is displayed, select "Yes", then press **ENTER**.

### 6 After inputting the username and password, select "Log In", then press ENTER.

If the username and password match, the top menu for Spotify is displayed.

### 7 Use $\Delta \nabla$ to select menu and then press ENTER.

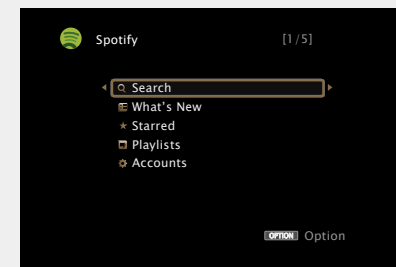

- Search** Searches for tracks, artists and albums by entering keywords.
- What's New** Displays the list of the latest albums.
- Starred** Displays the list of the starred tracks.
- Playlists** Displays the playlists for Spotify.
- Accounts** Manages accounts (Log out, Add new user, Switch to user).

### 8 Use $\Delta \nabla$ to select a station, and press ENTER or $\triangleright$ to start playback.

Playback starts and the following screen appears.

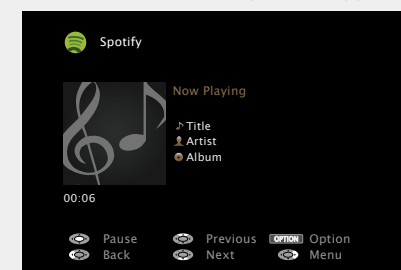

## 9 Press **▷** while a track is playing.

The Spotify menu screen is displayed.

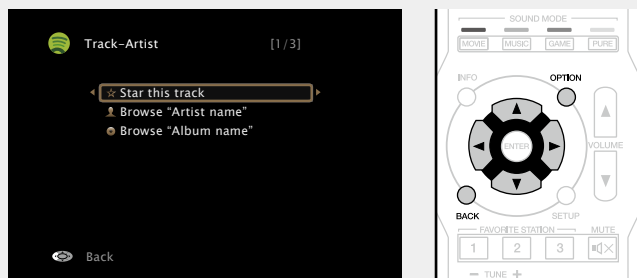

**Star this track** Adds a star to the selected track.

**Browse "Artist name"** Displays the list of albums by the artist of the track that is being played back.

**Browse "Album name"** Displays the list of tracks on the album that is being played back.

## ❑ Adjusting the sound quality (M-DAX)

Make this setting at "M-DAX" ([page 96](#)) in the menu.

You can use the M-DAX function to improve the fidelity of compressed audio sources such as content from streaming music services. The M-DAX has selectable levels of restoration. The default setting is "Off".

## ❑ Switching the screen display

Press **STATUS** on the main unit.

The display switches between track title, artist name, and album title each time the button is pressed.

## ❑ Going back to the previous screen

Press **◀** or **BACK**.

## ❑ Changing the screen display duration

Make this setting at "Now Playing" ([page 101](#)) in the menu. The default setting is "Always On".

When "Auto Off" is set, the on-screen display is turned off 30 seconds after an operation.

Press **△▽◀▷** while the display is off to return to the original screen.

## Operations available through the OPTION button

Press the **OPTION** button to display a menu of functions that can be used on the TV screen. Select the function you want to use from this menu. You can easily find and use the desired function.

### ❑ Performing repeat playback (Repeat)

([page 65](#))

### ❑ Performing random playback (Random)

([page 66](#))

### ❑ Displaying your desired video on the monitor during audio playback (Video Select) ([page 69](#))

## ❑ Spotify operation buttons

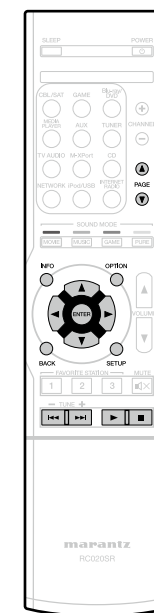

Operation buttons	Function
<b>PAGE ▲▼</b>	Page search
<b>INFO</b>	Display of information such as the source name, volume, and sound mode name
<b>OPTION</b>	Repeat playback / Random playback / Video Select
<b>△▽◀▷</b>	Cursor operation / Next/Previous (△▽) / Fast-forward/Fast-reverse (Press and hold, △▽)
<b>ENTER</b> (Press and release)	Enter
<b>ENTER</b> (Press and hold)	Stop
<b>BACK</b>	Return
<b>SETUP</b>	Setup menu
<b>◀▶</b> (Press and release)	Next/Previous
<b>◀▶</b> (Press and hold)	Fast-forward/Fast-reverse
<b>▶</b>	Playback
<b>  </b>	Pause

## Convenient functions

Here, we explain how to use convenient functions for NETWORK sources and USB sources. The source names under the titles of each function's description are sources that allow use of these functions.

❑ **Searching content with keywords (Text Search)** (👉 page 65)

❑ **Performing repeat playback (Repeat)** (👉 page 65)

❑ **Performing random playback (Random)** (👉 page 66)

❑ **Favorites function** (👉 page 67)

❑ **Playing back music and a favorite picture at the same time (Slideshow)** (👉 page 68)

❑ **Playing back still images in sequential order (Slideshow Time)** (👉 page 68)

## Searching content with keywords (Text Search)

USB Internet Radio Media Server

**1** While content is playing, press **OPTION**.  
The option menu screen is displayed.

**2** Use  $\Delta$ / $\nabla$  to select "Text Search", then press **ENTER**.  
The keyboard input screen is displayed.



**3** Enter the first character of the Internet Radio station or file you want to search for, and then press **OK**.

• For character input, see page 92.



"Text Search" searches for Internet Radio stations or files that start with the entered first character from the displayed list.

### NOTE

"Text Search" may not work for some lists.

### ❑ Playing back a search result content

Use  $\Delta$ / $\nabla$  to select the content you want to play, and then press **ENTER** or  $\triangleright$ .

Playback starts.

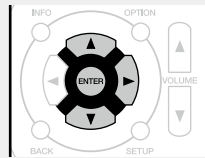

## Performing repeat playback (Repeat)

USB Media Server Spotify

**1** While content is playing, press **OPTION**.  
The option menu screen is displayed.

**2** Use  $\Delta$ / $\nabla$  to select "Repeat", then press **ENTER**.

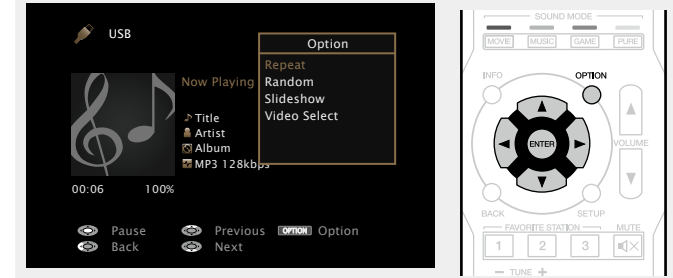

**3** Use  $\triangleleft$ / $\triangleright$  to select repeat playback mode.

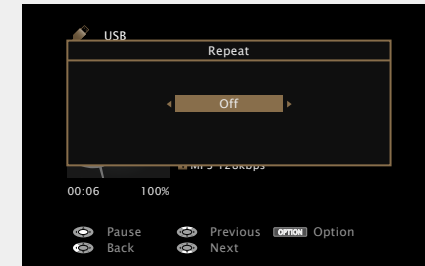

• Each time  $\triangleleft$ / $\triangleright$  is pressed, the setting is changed as shown below.



**Off** Repeat playback mode is canceled.

**One** A file being played is played repeatedly.

**All** All files in the folder currently being played are played repeatedly.

**4** Press **ENTER**.  
The display returns to the playback screen.

## Performing random playback (Random)

USB Media Server Spotify

**1** While content is playing, press **OPTION**.  
The option menu screen is displayed.

**2** Use  $\Delta$ / $\nabla$  to select “Random”, then press **ENTER**.

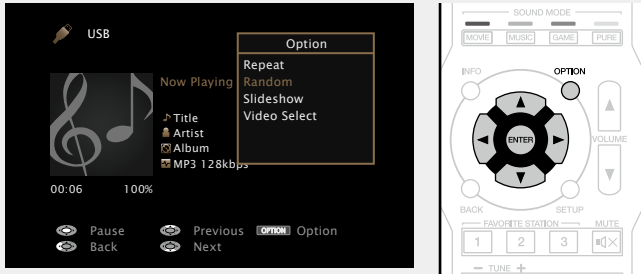

**3** Use  $\triangleleft$ / $\triangleright$  to select random playback mode.

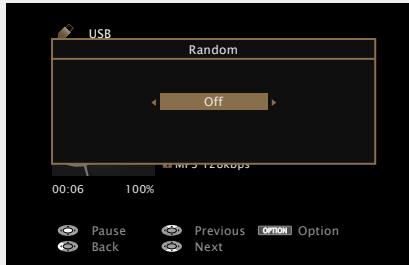

• Each time  $\triangleleft$ / $\triangleright$  is pressed, the setting is changed as shown below.

Off  $\longleftrightarrow$  On

**Off** Disable random playback.

**On** Randomly play back all tracks in the current playback folder.

**4** Press **ENTER**.  
The display returns to the playback screen.



During random playback, each time playback of a track is completed, another track is randomly selected for playback from tracks in the folder. Therefore, it's possible that you may hear a track played back more than once during random playback.

## Favorites function

There are two ways to add content to favorites:

- ① Add to favorites from the Option menu
- ② Add to the **FAVORITE STATION** button

### ❑ Add to favorites from the Option menu (Save to Favorite)

**Internet Radio** **Media Server**

You can add up to 100 items as favorites for all sources (Internet Radio and Media Server).

#### 1 While content is playing, press **OPTION**.

The option menu screen is displayed.

#### 2 Use $\Delta \nabla$ to select “Save to Favorite”, then press **ENTER**.

“Favorite added” is displayed, and the current content is added to favorites.

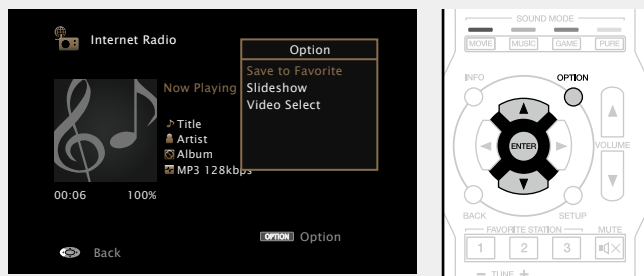

- The display returns to the playback screen when the procedure is completed.

## Playing back content added in “Save to Favorite”

### 1 Press **NETWORK**.

### 2 Use $\Delta \nabla \triangleleft \triangleright$ to select “Favorites”, then press **ENTER**.

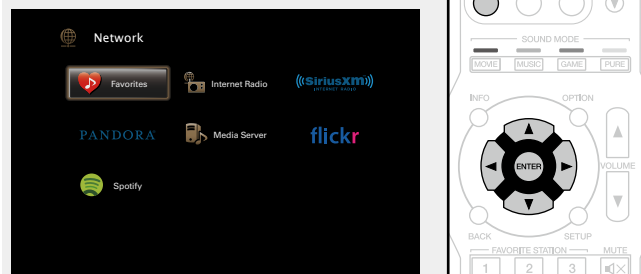

### 3 Use $\Delta \nabla$ to select the content you want to play, and then press **ENTER** or $\triangleright$ . Playback starts.

### ❑ Adding to the **FAVORITE STATION** button

You can add up to three types of content.

#### NOTE

- Please note that if you add new content to a number that already contains content, the older content is deleted.
- The following operations update the database on the Media Server, which may make the added music files unplayable.
  - When you quit the Media Server and then restart it.
  - When music files are deleted or added on the Media Server.
- When using an ESCIENT server, place “ESCIENT” before the server name.

### Press and hold one of the **FAVORITE STATION 1 – 3** buttons for 3 seconds or longer while playing back a content or listening to a radio station.

The content you are playing back or the radio station you are listening to is registered to the pressed button.

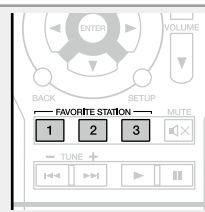

Contents that can be added to the **FAVORITE STATION** button differ depending on the input source.

Input source	Contents that can be added
<b>TUNER</b>	Radio station
<b>Internet Radio</b>	Top list of content / Internet Radio station
<b>Media Server</b>	Top list of content / Track
<b>Flickr</b>	Top list of content
<b>Pandora</b>	Top list of content
<b>SiriusXM</b>	Top list of content
<b>Spotify</b>	Top list of content
<b>Favorites</b>	Top list of content / Internet Radio station / Track of Media Server

## Playing back content added to the **FAVORITE STATION** button

You can easily call up content by pressing the **FAVORITE STATION** button.

### Press one of the **FAVORITE STATION 1 – 3** buttons that you added content to. Playback starts.

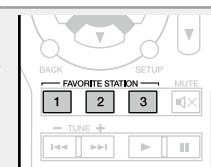

Internet Radio stations are already registered to the **FAVORITE STATION 1 – 3** buttons. However, you may not be able to play the stations due to restrictions imposed by the radio stations.

## Deleting content added to favorites (Remove from Fav.)

**1** Press **NETWORK**.

**2** Use  $\Delta \nabla \triangleleft \triangleright$  to select  
“Favorites”, then press **ENTER**.

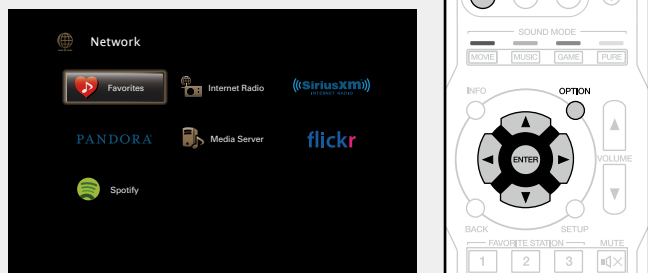

**3** Use  $\Delta \nabla$  to select the content you want to delete from favorites, then press **OPTION**.  
The option menu screen is displayed.

**4** Use  $\Delta \nabla$  to select “Remove from Fav.”, then press **ENTER**.  
“Favorite removed” is displayed, and the selected content is deleted from favorites.

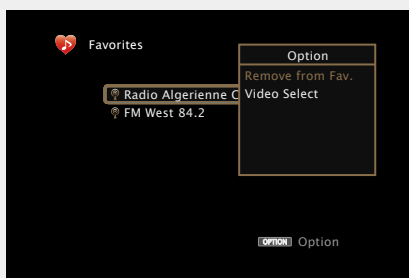

• The display returns to the original screen when the procedure is completed.

## Playing back music and a favorite picture at the same time (Slideshow)

**USB** **Internet Radio** **Media Server**

**1** Play back a still picture.

- Playing back still pictures stored on USB memory devices (page 36).
- Playing back still pictures stored on Flickr (page 55).

**2** Play back a music file or Internet Radio station (page 47, 52).

**3** Press **OPTION**.  
The option menu screen is displayed.

**4** Use  $\Delta \nabla$  to select “Slideshow”, then press **ENTER**.  
The option menu disappears, and the picture you were viewing is shown on the screen.

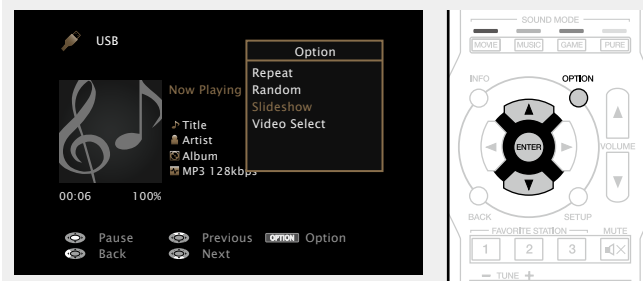

## Playing back still images in sequential order (Slideshow Time)

You can play back still image (JPEG) files stored on a USB memory device or Media Server and pictures on Flickr website as a slide show. The display time can also be set.

**USB** **Media Server** **Flickr**

**1** Play back an image and press **OPTION**.  
The option menu screen is displayed.

**2** Use  $\Delta \nabla$  to select “Slideshow Time”, then press **ENTER**.

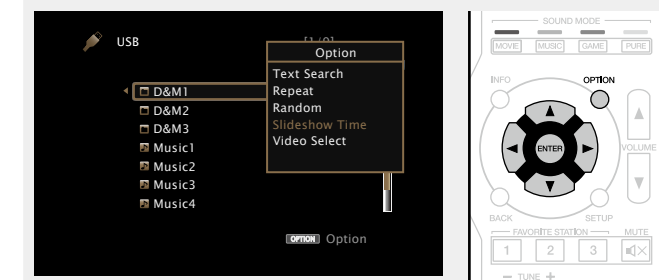

**3** Use  $\triangleleft \triangleright$  to set the display time.

- Each time  $\triangleleft \triangleright$  is pressed, the setting is changed as shown below.

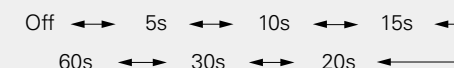

**Off** The slide show is not played back.

**5s – 60s** Set the time for displaying a single image when playing back images in the slide show.

**4** Press **ENTER**.  
The slide show is displayed on the screen.



This unit plays back image (JPEG) files in the orientation in which they are stored in the folder.

## Displaying your desired video on the monitor during audio playback (Video Select)

This unit can display video from a different source on TV during audio playback.

You can set this for each input source.

**USB** **TUNER** **NETWORK**

### 1 Press **OPTION** during audio playback.

The option menu screen is displayed.

### 2 Use $\Delta$ / $\nabla$ to select “Video Select”, then press **ENTER**.

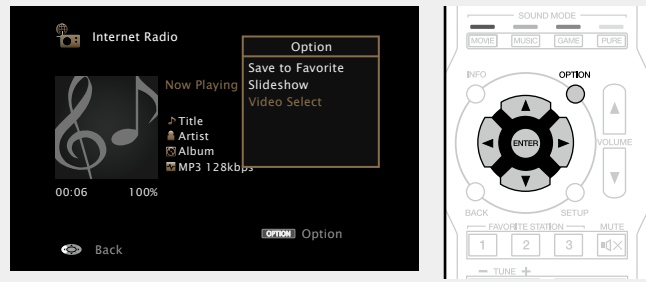

### 3 Use $\triangleleft$ / $\triangleright$ to select the Video Select mode.

- Each time  $\triangleleft$ / $\triangleright$  is pressed, the setting is changed as shown below.

Off  $\longleftrightarrow$  On

**Off** Disable Video Select mode.

**On** Enable Video Select mode.

### 4 If you selected “On” in step 3, press $\nabla$ and select “Source”.

### 5 Press $\triangleleft$ / $\triangleright$ to select the input source for video you want to play back, and press **ENTER**.

Playback starts.

#### NOTE

Input sources for which “Hide” is selected at “Hide Sources” ([page 105](#)) cannot be selected.



## AirPlay function

Enjoy music from your iTunes library with high quality sound anywhere in your home.

Use the Apple Remote App\* for iPhone, iPod touch and iPad to control iTunes from any room in your home.

\* Available as a free download from the App Store.

### Streaming music stored in iPhone, iPod touch, or iPad directly to the unit

If you update your "iPhone/iPod touch/iPad" to iOS 4.2.1 or later, you can stream music stored in your "iPhone/iPod touch/iPad" directly to this unit.

#### 1 Make the Wi-Fi settings for iPhone, iPod touch, or iPad.

• For details, see your device's manual.

#### 2 Startup iPhone, iPod touch, or iPad music or iPod app.

 is displayed on the iPhone, iPod touch or iPad screen.

#### 3 Tap the AirPlay icon .

#### 4 Select the speaker you want to use.

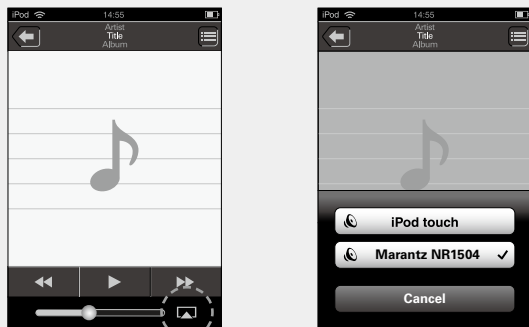

#### NOTE

In playback using the AirPlay function, the sound is output at the iPhone, iPod touch, iPad or iTunes volume setting level.

You should turn down the iPhone, iPod touch, iPad or iTunes volume prior to playback and then adjust it to a suitable level.

### Playing iTunes music with this unit

#### 1 Install iTunes 10, or later, on a Mac or Windows PC that is connected to the same network as this unit.

#### 2 Turn this unit ON.

Set "IP Control" ([see page 111](#)) to "Always On" for this unit.

#### NOTE

When "IP Control" is set to "Always On", the unit consumes more standby power.

#### 3 Launch iTunes and click the AirPlay icon displayed the window and select this unit from the list.



#### 4 Choose a song and click play in iTunes.

The music will stream to this unit.

### Selecting multiple speakers (devices)

It is possible to play iTunes songs on your home's AirPlay compatible speakers (devices) other than those of this unit.

#### 1 Click the AirPlay icon and select "Multiple".

#### 2 Check the speakers you want to use.

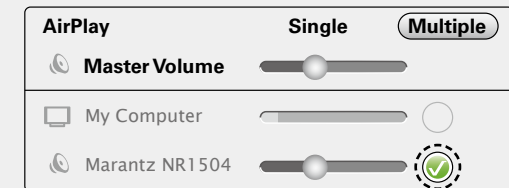

## □ Perform iTunes playback operations with the remote control unit of this unit

With this unit's remote control unit, you can perform iTunes song play, pause, and auto search (cue) operations.

**1** Select “Edit” – “Preferences...” on the menu.

**2** Select “Devices” in the iTunes setting window.

**3** Check “Allow iTunes audio control from remote speakers”, and then click “OK”.

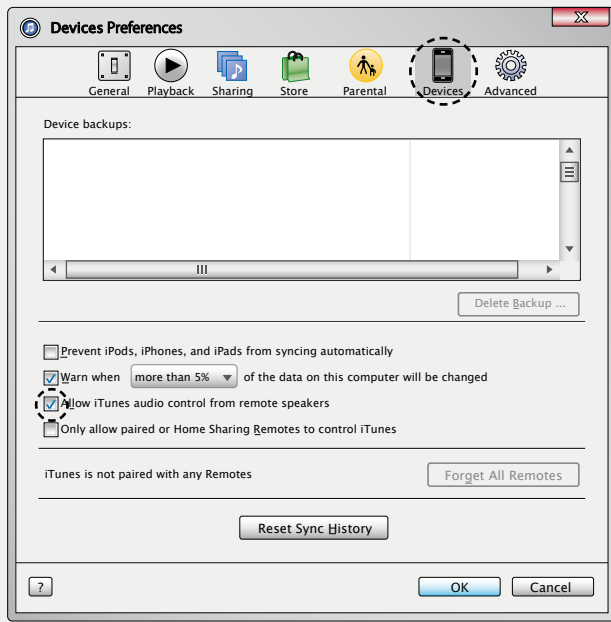

•  is displayed on the menu screen while AirPlay is being operated.

• Source input will be switched to “NETWORK” when AirPlay playback is started.

• You can stop AirPlay playback by pressing the ◀ or choosing other input source.

• To see song and artist names together, press **STATUS** on the main unit.

• For information about how to use iTunes, also see the Help for iTunes.

• The screen may differ depending on the OS and software versions.

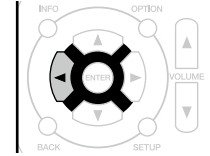

# Selecting a listening mode (Sound Mode)

This unit allows you to enjoy various kinds of surround and stereo playback modes.

Multi-channel audio formats are provided on popular movie and music disc formats such as Blu-ray and DVD, as well as being supported by digital broadcasting, and even by streaming movies and music from internet-based subscription services.

This unit supports playback of almost all of these multi-channel audio formats. It also supports surround playback of audio formats other than multi-channel audio such as 2-channel stereo audio.

This unit automatically generates a list of all the playable sound modes based on the input audio format and the current speaker setup configuration and displays the list on the screen. Therefore, you can select a correct surround playback mode even if you are not familiar with sound mode selection. Try out various surround playback modes and enjoy surround playback in your favorite mode.

**[Example]** When **MOVIE** is pressed and held

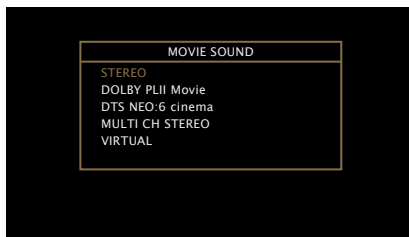

The displayed sound modes include the 2-channel stereo playback mode with no additional surround sound synthesis.



For audio formats recorded on a disc, see the disc jacket or label.

## Selecting a listening mode

### 1 Play the selected device (page 31 – 63).

### 2 Press and hold **MOVIE**, **MUSIC** or **GAME** to select a listening mode.

This unit automatically generates and displays a list of selectable sound modes.

- Each time **MOVIE**, **MUSIC** or **GAME** is pressed, the listening mode is switched.

**MOVIE** Switches to the listening mode suitable for enjoying movies and TV programs.

**MUSIC** Switches to the listening mode suitable for enjoying music.

**GAME** Switches to the listening mode suitable for enjoying games.

- Pressing **MOVIE**, **MUSIC** or **GAME** displays a list of the listening modes that can be selected. Each time you press **MOVIE**, **MUSIC** or **GAME**, the listening mode changes.
- While the list is displayed, you can also use  $\Delta$ / $\nabla$  to select a listening mode.

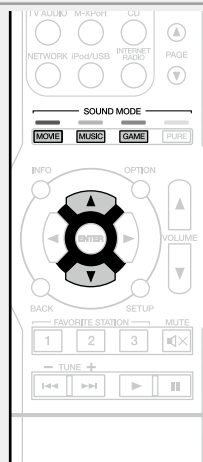

## Direct playback

Sound recorded in source is played as is.

### 1 Play the selected device (page 31 – 63).

### 2 Press **PURE** to select “DIRECT”. Direct playback begins.

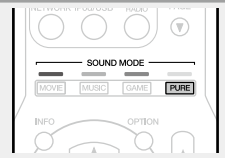

- The **MOVIE**, **MUSIC**, or **GAME** button memorizes the last sound mode selected for its button. Pressing **MOVIE**, **MUSIC**, or **GAME** recalls the same sound mode as the one selected at the previous playback.
- If the content played back does not support the previously selected sound mode, the most appropriate sound mode for the content is automatically selected.

## Pure Direct playback

This mode is for playback with higher sound quality than in “DIRECT” mode, by turning off the front panel display panel, which can eliminate faint low level noise from creeping into sensitive analog circuitry.

**1** Play the selected device  
([page 31 – 63](#)).

**2** Press **PURE** to select “**PURE DIRECT**”.

PURE DIRECT indicator on the main unit lights.  
The display goes dark, and pure direct playback begins.

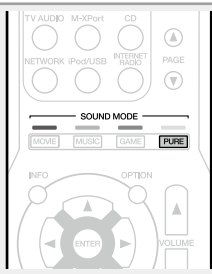

## Auto surround playback

This mode detects the type of input digital signal, and automatically selects the corresponding mode for playback.

**1** Play the selected device  
([page 31 – 63](#)).

**2** Press **PURE** to select “**AUTO**”.  
Auto surround playback begins.

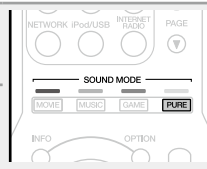

- In DIRECT and PURE DIRECT listening modes, the following items cannot be adjusted.
  - Tone ([page 95](#))
  - M-DAX ([page 96](#))
  - MultEQ® ([page 97](#))
  - Dynamic EQ ([page 97](#))
  - Dynamic Volume ([page 97](#))
- This can also be set by pressing **PURE DIRECT** on the main unit.

### NOTE

- Video signals are only output when HDMI signals are played in the PURE DIRECT mode.
- When in the PURE DIRECT mode, the menu screen is not displayed.
- When in the PURE DIRECT mode, the display turns off and appears as if there is no electricity.

## Listening mode

- The following listening modes can be selected using the **MOVIE**, **MUSIC**, **GAME**, and **PURE** buttons.
- Adjust the sound field effect with the menu "Surr.Parameter" ([page 94](#)) to enjoy surround sound the way you like it.

Operation button	Input signal	Listening mode	
<b>MOVIE</b> <input type="checkbox"/>	2-channel *1	STEREO	
		AUTO *2	
		DOLBY PLII Movie *3	
		DTS NEO:6 Cinema*3	
		MULTI CH STEREO	
	VIRTUAL		
	Multi-channel *4	STEREO	
		AUTO *2	
		Dolby Digital	DOLBY DIGITAL
		Dolby TrueHD	DOLBY TrueHD
		Dolby Digital Plus	DOLBY DIGITAL Plus
		DTS	DTS SURROUND DTS 96/24
		DTS-HD / DTS Express	DTS-HD HI RES DTS-HD MSTR DTS Express
		PCM multi-channel	MULTI CH IN
MULTI CH STEREO VIRTUAL			

Operation button	Input signal	Listening mode	
<b>MUSIC</b> <input type="checkbox"/>	2-channel *1	STEREO	
		AUTO *2	
		DOLBY PLII Music *3	
		DTS NEO:6 Music *3	
		MULTI CH STEREO	
	VIRTUAL		
	Multi-channel *4	STEREO	
		AUTO *2	
		Dolby Digital	DOLBY DIGITAL
		Dolby TrueHD	DOLBY TrueHD
		Dolby Digital Plus	DOLBY DIGITAL Plus
		DTS	DTS SURROUND DTS 96/24
		DTS-HD / DTS Express	DTS-HD HI RES DTS-HD MSTR DTS Express
		PCM multi-channel	MULTI CH IN
MULTI CH STEREO VIRTUAL			

- \*1 2-channel also includes analog input.
- \*2 When AUTO mode is selected, the sound mode that is compatible with the input signal is used for playback.
- \*3 This mode plays back 2-channel sources in 5.1-channel playback. It cannot be selected when headphones are used, or when only front speakers are used.
- \*4 Some listening modes cannot be selected, depending on the audio format or number of channels of the input signal. For details, see "Types of input signals, and corresponding sound modes" ([page 128](#)).

Operation button	Input signal	Listening mode	
<b>GAME</b> <input type="checkbox"/>	2-channel *1	STEREO	
		AUTO *2	
		DOLBY PLII Game *3	
		MULTI CH STEREO	
		VIRTUAL	
	Multi-channel *4	STEREO	
		AUTO *2	
		Dolby Digital	DOLBY DIGITAL
		Dolby TrueHD	DOLBY TrueHD
		Dolby Digital Plus	DOLBY DIGITAL Plus
		DTS	DTS SURROUND DTS 96/24
		DTS-HD / DTS Express	DTS-HD HI RES DTS-HD MSTR DTS Express
		PCM multi-channel	MULTI CH IN MULTI CH STEREO VIRTUAL
<b>PURE</b> <input type="checkbox"/>	All	DIRECT	
		PURE DIRECT	
		AUTO *2	

\*1 2-channel also includes analog input.

\*2 When AUTO mode is selected, the sound mode that is compatible with the input signal is used for playback.

\*3 This mode plays back 2-channel sources in 5.1-channel playback. It cannot be selected when headphones are used, or when only front speakers are used.

\*4 Some listening modes cannot be selected, depending on the audio format or number of channels of the input signal. For details, see "Types of input signals, and corresponding sound modes" ([page 128](#)).

## Views on the TV screen or display

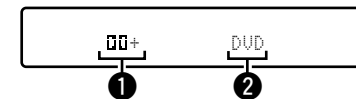

① Shows a decoder to be used.

- A DOLBY DIGITAL Plus decoder is displayed as "DOLBY DIGITAL Plus".

② Shows the name of the input source being played back.

## □ Description of listening mode types

### Dolby listening mode

Listening mode type	Description
DOLBY PLII	This mode can be selected when the Dolby Pro Logic II decoder is used to play back 2-channel sources in 5.1-channel surround sound with an enveloping surround sound experience.
DOLBY DIGITAL	This mode can be selected when playing sources recorded with Dolby Digital.
DOLBY TrueHD	This mode can be selected when playing sources recorded in Dolby TrueHD.
DOLBY DIGITAL Plus	This mode can be selected when playing sources recorded with Dolby Digital Plus.

### DTS listening mode

Listening mode type	Description
DTS NEO:6	This mode can be selected when a DTS NEO:6 decoder is used to play back 2-channel source in 5.1-channel surround sound. There is a "Cinema" mode optimized for movie playback, and a "Music" mode optimized for music playback.
DTS SURROUND	This mode can be selected when playing sources recorded in DTS.
DTS 96/24	This mode can be selected when playing sources recorded in DTS 96/24.
DTS-HD	This mode can be selected when playing sources recorded in DTS-HD.
DTS Express	This mode can be selected when playing sources recorded in DTS Express.

### PCM multi-channel listening mode

Listening mode type	Description
MULTI CH IN	This mode can be selected when playing multi-channel PCM sources from a disc player.

### Original listening mode

Listening mode type	Description
MULTI CH STEREO	This mode is for enjoying stereo sound from all speakers. Stereo audio (2 channel) sources are played back via the front (L/R) speakers, the surround speakers.
VIRTUAL	This mode lets you experience an expansive surround sound effect when playing back through just the front (L/R) speakers only, and when listening with stereo headphones.

### AUTO listening mode

Listening mode type	Description
AUTO	In this mode, the type of digital signal input, such as Dolby Digital, Dolby TrueHD, Dolby Digital Plus, DTS, DTS-HD, PCM (multi-channel) is detected, and the playback mode switches automatically to the corresponding mode. If the input signal is analog or PCM (2-channel), stereo playback is used.

### STEREO listening mode

Listening mode type	Description
STEREO	This mode plays 2-channel stereo audio with no additional surround sound processing. <ul style="list-style-type: none"> <li>• Sound is output from the front left and right speakers, and subwoofer if connected.</li> <li>• When multi-channel signals are inputted, they are mixed down to 2-channel audio and are played back with no additional surround sound processing.</li> </ul>





### Direct listening mode

Listening mode type	Description
DIRECT	This mode provides a direct input-to-output path with minimal audio processing, bypassing any unnecessary stages for purest sound.
PURE DIRECT	This mode provides the direct audio signal path benefit of the Direct mode along with disabling additional stages that might possibly have an affect on sound quality. In Pure Direct mode, the following elements are turned off: <ul style="list-style-type: none"> <li>• The front panel display and its driver circuitry are shut down.</li> <li>• The analog video input/output switcher and processor is disabled.</li> </ul>

## Advanced instructions

---

Here we explain functions and operations in more detail so that you can maximize your enjoyment with this unit.

- **Installation/connection/setup of speakers (Advanced)**  [page 78](#)
- **Installation/connection/setup of speakers (Advanced)**  [page 82](#)
- **Playback (Advanced operation)**  [page 83](#)
- **How to make detailed settings**  [page 89](#)



# Installation/connection/setup of speakers (Advanced)

## Procedure for speaker settings

Speaker installation



Speaker connection ([page 79](#))

## Speaker installation

- Determine the speaker system depending on the number of speakers you are using and install each speaker and subwoofer in the room. Here, we explain how to install the speakers using a typical example.
- The speaker impedance should be from 6 to 16  $\Omega$ /ohms.



Use the illustration below as a guide for how high each speaker should be installed. The height does not need to be exactly the same.

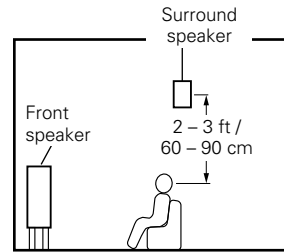

[Viewed from the side]

## When 5.1-channel speakers are installed

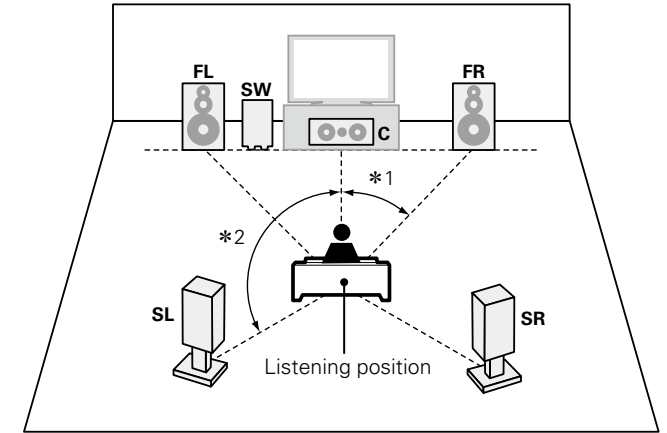

\*1 22° - 30° \*2 120°

### [Speaker abbreviations]

<b>FL</b>	Front speaker (L)	<b>SW</b>	Subwoofer
<b>FR</b>	Front speaker (R)	<b>SL</b>	Surround speaker (L)
<b>C</b>	Center speaker	<b>SR</b>	Surround speaker (R)

## Speaker connection

Here we connect the speakers in the room to this unit.

This section explains how to connect them using typical examples.

- ❑ **Connecting 5.1-channel speakers** (👉 [page 81](#))
- ❑ **Connecting 2.1-channel speakers** (👉 [page 81](#))

### NOTE

- **Disconnect this unit's power plug from the power outlet before connecting the speakers. Also, turn off the subwoofer.**
- **Connect so that the speaker cable core wires do not protrude from the speaker terminal. The protection circuit may be activated if the core wires touch the rear panel or if the + and - sides touch each other** (👉 [page 131](#) "Protection Circuit").
- **Never touch the speaker terminals while the power cord is connected. Doing so could result in electric shock. When the "Setup Assistant" is running, follow the instructions in the "Setup Assistant" screen for making connections. (Power is not supplied to the speaker terminals while the "Setup Assistant" is running.)**
- **Use speakers with the speaker impedances shown below.**

Speaker terminals	Speaker impedance
FRONT	6 – 16 Ω/ohms
CENTER	
SURROUND	

## Connecting the speaker cables

Carefully check the left (L) and right (R) channels and + (red) and – (black) polarities on the speakers being connected to this unit, and be sure to connect the channels and polarities correctly.

- 1 Peel off about 3/8 inch (10 mm) of sheathing from the tip of the speaker cable, then either twist the core wire tightly or terminate it.**



- 2 Turn the speaker terminal counterclockwise to loosen it.**

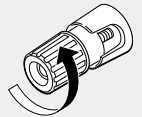

- 3 Insert the speaker cable's core wire to the hilt into the speaker terminal.**

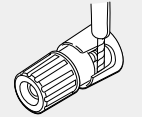

- 4 Turn the speaker terminal clockwise to tighten it.**

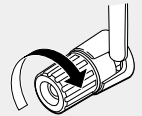

## Cables used for connections

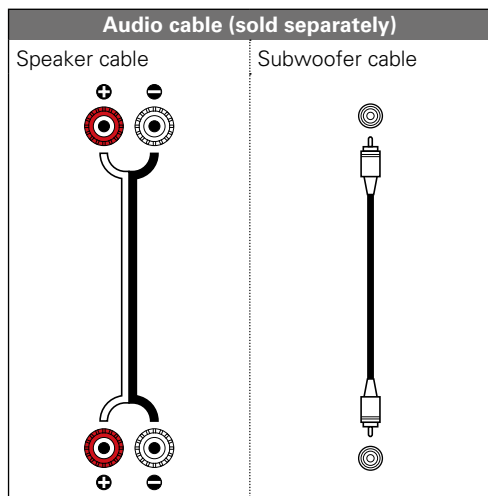

## Connecting the subwoofer

Use a subwoofer cable to connect the subwoofer.

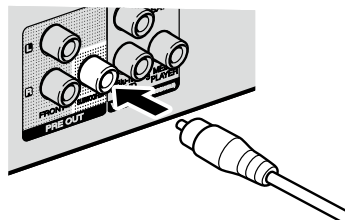

## About the speaker cable label (supplied) for channel identification

The channel display section for speaker terminals on the rear panel is color-coded for each channel to be identifiable.

Speaker terminals	Color
FRONT L	White
FRONT R	Red
CENTER	Green
SURROUND L	Light blue
SURROUND R	Blue

Attach the speaker cable label for each channel to its speaker cable as shown in the diagram. Then, make connection so that the color of the speaker terminal matches that of the speaker cable label.

### [How to attach the speaker cable label]

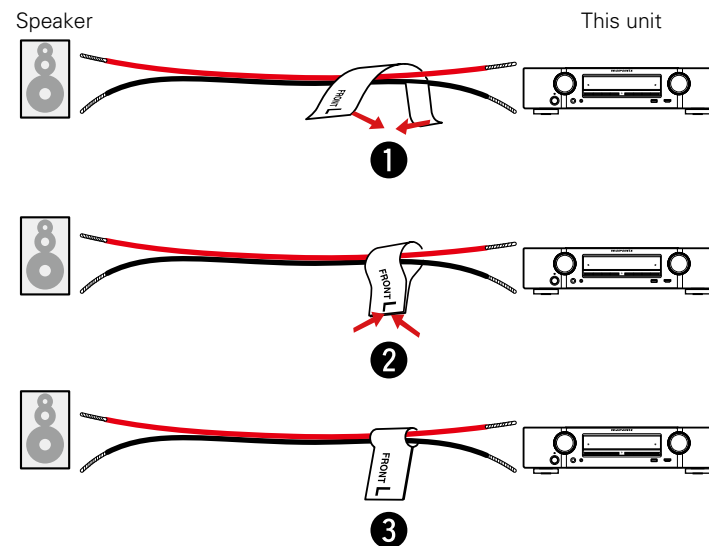

## Connecting 5.1-channel speakers

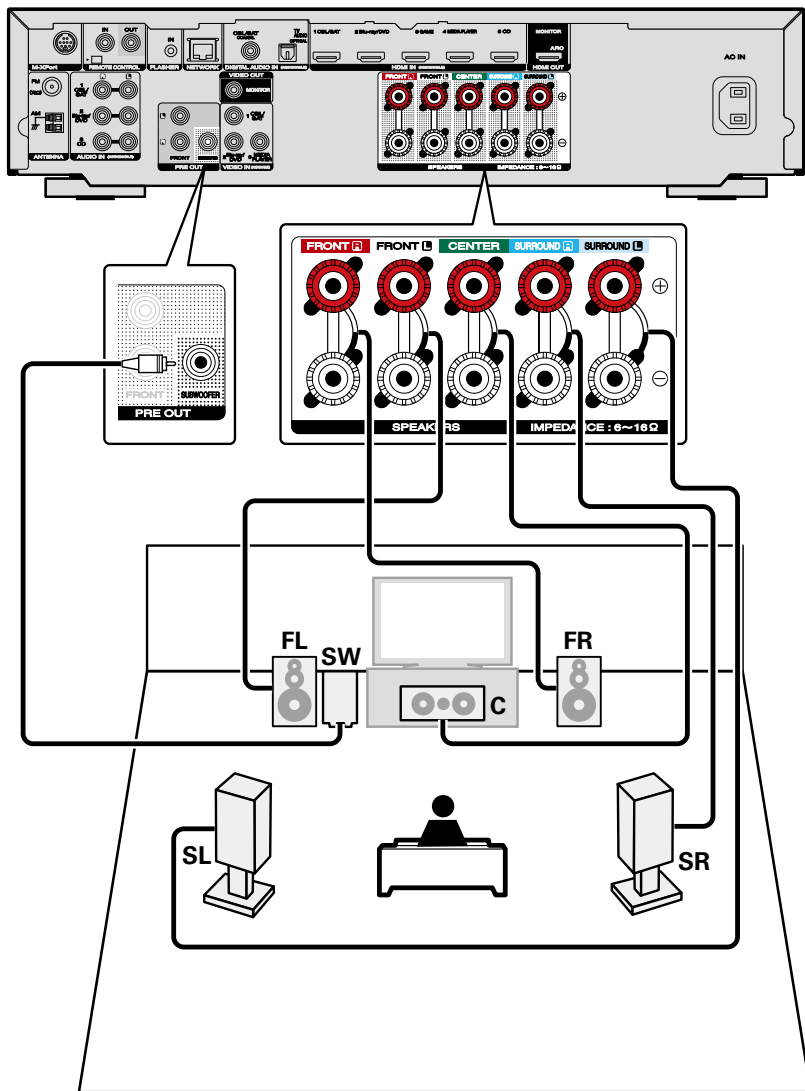

**NOTE**

- For speaker cable connections, see [page 80](#).
- For speaker impedance, see [page 79](#).

## Connecting 2.1-channel speakers

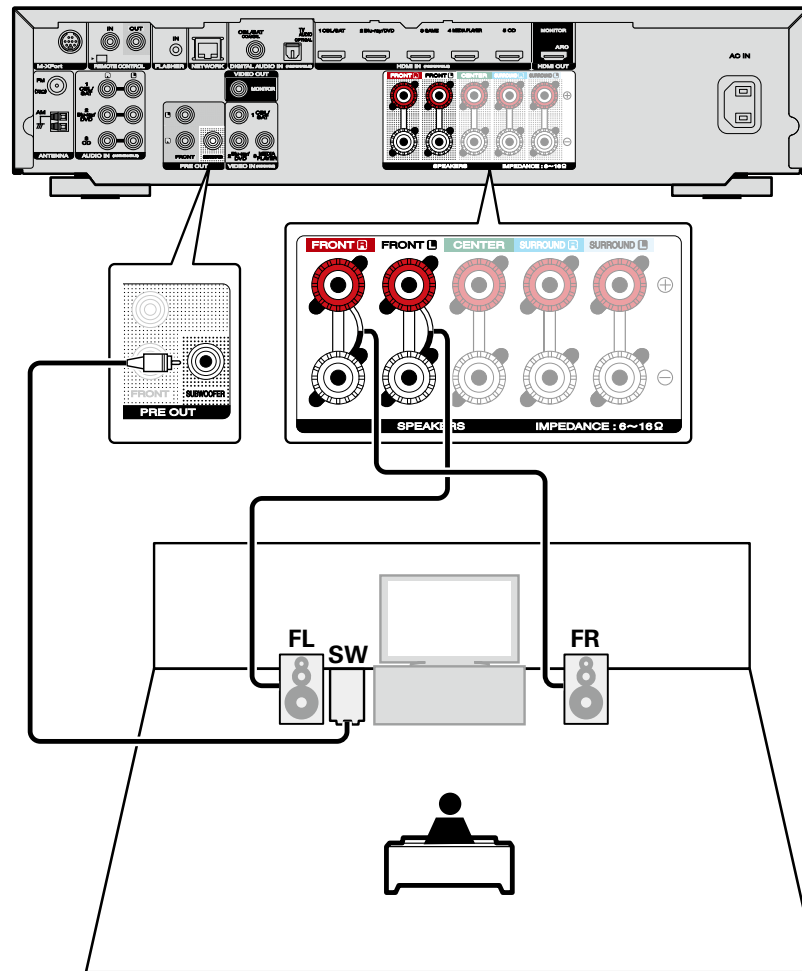

**NOTE**

- For speaker cable connections, see [page 80](#).
- For speaker impedance, see [page 79](#).

# Connections (Advanced connection)

## Connecting the REMOTE CONTROL connectors

### Remotely connecting Marantz devices

#### □ Performing operations by RC on this unit without visual contact

- You can connect an external IR receiver to the REMOTE CONTROL connectors to perform operations on this unit with the supplied remote control unit without visual contact. This might be necessary if the unit is hidden in a cupboard or corner, so you can't directly point with the remote control unit to the device.
- To do this, disable the remote control signal receiving function ([page 88](#) "Remote lock function").

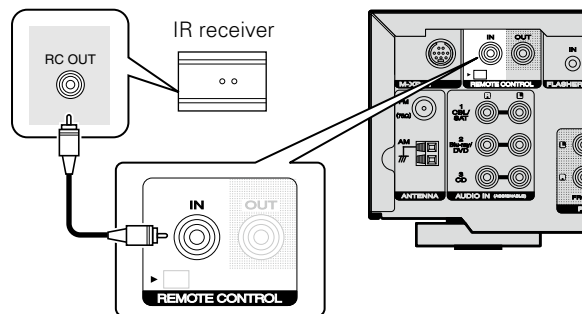

#### NOTE

When not connecting an IR receiver, make sure to enable the remote control signal receiving function. When the function is disabled, you can not perform operations with the remote control unit.

#### □ Remotely connecting Marantz devices

- When you are using a Marantz device other than this unit that supports remote connection, you can transmit remote control signals just by connecting the device to the REMOTE CONTROL IN/ OUT connector with a monaural cable.
- Set the remote control switch located on the rear panel of the connected audio component to "EXTERNAL" or "EXT." to use this feature.

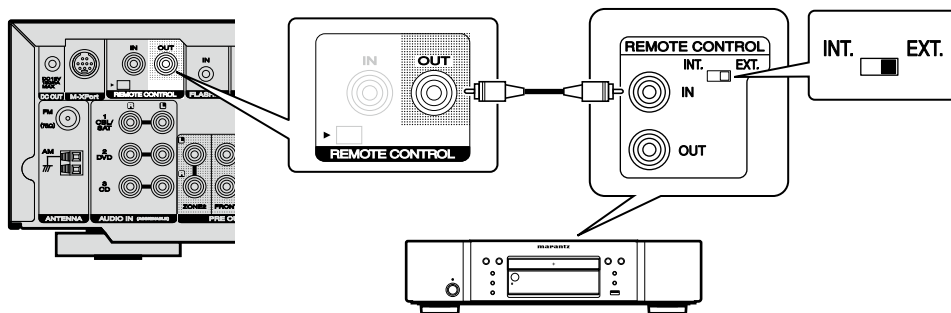

### Remotely control a Marantz Blu-ray player by the Marantz Remote App

Marantz Blu-ray disc player of newer generation also can be controlled via a network receiver unit using the Marantz Remote App. Please ensure REMOTE CONTROL system of the receiver unit and the BD-Player is set up as shown in the previous section.

# Playback (Advanced operation)

Setup (👉 page 23)

Playback (Basic operation) (👉 page 30)

Selecting a listening mode (Sound Mode)  
(👉 page 72)

- ❑ HDMI control function (👉 page 83)
- ❑ Sleep timer function (👉 page 84)
- ❑ Web control function (👉 page 85)
- ❑ Dual backup memory function (👉 page 86)
- ❑ Panel lock function (👉 page 87)
- ❑ Remote lock function (👉 page 88)
- ❑ Various memory functions (👉 page 88)

## HDMI control function

A recent addition to the HDMI standard is CEC, which allows control signals from one device to communicate with another device via the HDMI cable connection. Not all HDMI-equipped devices allow .

### ❑ Operations possible by HDMI control

- **This unit's power off function can be linked to the TV power off operation.**
- **You can switch audio output devices with a TV operation.**  
When you set "Output audio from amp" in the TV audio output setup operation, you can switch the AV receiver unit's power on.
- **You can adjust this unit's volume in the TV volume adjustment operation.**
- **You can switch this unit's input sources through linkage to TV input switching.**
- **When playing a disc player, this unit's input source switches to the appropriate source for that player.**
- **If you switch the input source of the unit to "TV AUDIO", you can play TV audio with this unit (👉 page 8 "About ARC (Audio Return Channel) function").**
- **When "HDMI Control" (👉 page 100) in the menu is set to "On", signals input to the HDMI input connector are output to the television or other device connected to the HDMI output connector, even if the power of this unit is in standby (pass-through function).**



To use this unit to play the audio of a TV that does not support the ARC function, connect the TV to this unit with an optical-digital or analog connection (👉 page 8).

### ❑ Setting procedure

- 1 Set the HDMI output connector corresponding with the HDMI control function.**  
Set "HDMI Control" (👉 page 100) to "On".
- 2 Turn the power on for all the devices connected by HDMI cable.**
- 3 Set the HDMI control function for all devices connected by HDMI cable.**
  - Please consult the operating instructions for the connected devices to check the settings.
  - Carry out steps 2 and 3 should any of the devices be unplugged.
- 4 Switch the television input to the HDMI input connected to this unit.**
- 5 Switch this unit input to the HDMI input source and check if the picture from the player is ok.**
- 6 When you turn the TV's power to standby, check that the power of this unit also goes to standby.**



If the HDMI control function does not operate properly, check the following points.

- Is the TV or player compatible with the HDMI control function?
- Is "HDMI Control" ([page 100](#)) set to "On"?
- Is "Power Off Control" ([page 100](#)) set to "All" or "Video"?
- Are the HDMI control function settings of all devices correct?

**NOTE**

- When "HDMI Control" is set to "On", it consumes more standby power.
- The HDMI control function controls operations of a TV that is compatible with the HDMI control function. Make sure that the TV and HDMI are connected when you perform HDMI control.
- Some functions may not operate depending on the connected TV or player. Check the owner's manual of each device for details beforehand.
- When "Power Off Control" on the menu is set to "Off" ([page 100](#)), this unit is not set to standby even if the connected device is in the standby mode.
- When connection changes are implemented, such as adding connections to HDMI devices, linked operations may be initialized. In this case, you will need to reconfigure the settings.
- When "HDMI Control" is set to "On", it is not possible to assign an HDMI connector to "TV AUDIO" at "Input Assign" ([page 103](#)).
- Should any of the operations below be performed, the interlocking function may be reset, in which case, repeat steps 2 and 3.
  - "Input Assign" - "HDMI" ([page 103](#)) setting has changed.
  - There is a change to the connection between the devices and the HDMI, or an increase in devices.

## Sleep timer function

You can have the power automatically switched to standby once a set time has elapsed. This is convenient for viewing and listening while going to sleep.

### Press SLEEP and display the time you want to set.

The **SLEEP** indicator on the display lights.



- The time switches as shown below each time **SLEEP** is pressed.

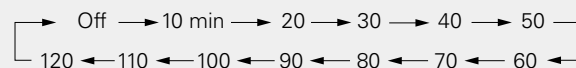

- This can also be set by pressing **SLEEP** on the main unit.

### To confirm the countdown time before putting the unit to sleep

- Press **SLEEP**.  
"Sleep : \*min" appears on the display.
- \* Countdown time

### To cancel the sleep timer

Press **SLEEP** to set "Off".

The **SLEEP** indicator on the display turns off.



The sleep timer setting is canceled if this unit's power is set to standby.

**NOTE**

The sleep timer function cannot turn off the power of devices connected to this unit. To turn off the power of those connected devices, set up sleep timers on the connected devices themselves.

# Web control function

You can control this unit from a web control screen on a web browser.



- This unit and the PC need to be connected to the network properly (page 21 “Connecting to a home network (LAN)”) in order to use the web control function.
- Depending on the settings of your security-related software, you may not be able to access this unit from your PC. If this is the case, then change the settings of the security-related software.

**1** Switch the “IP Control” setting to “Always On” (page 111).

**2** Check the IP address of this unit with “Information” (page 111).

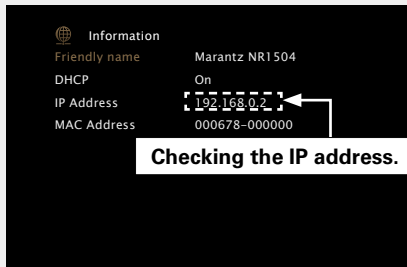

**3** Start up the web browser.

**4** Enter the IP address of this unit in browser’s address box.

For example, if the IP address of this unit is “192.168.0.2”, enter “http://192.168.0.2”.

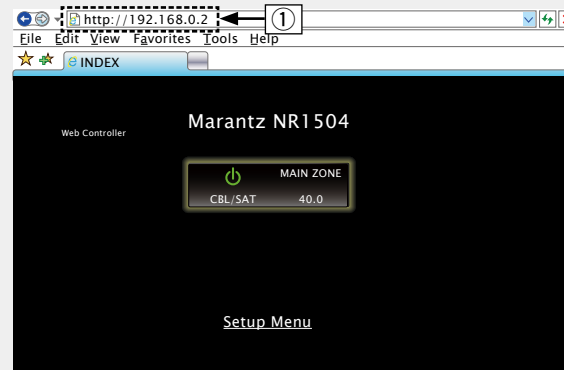

① Entering the IP address.

- By adding this unit’s IP address to the browser’s bookmark, you can display the web control screen using the bookmark function the next time you use the browser. If you are using a DHCP server and “IP Control” (page 111) is set to “Off In Standby”, turning the power on/off changes the IP address.

**5** When the top menu is displayed, click on the menu item you want to operate.

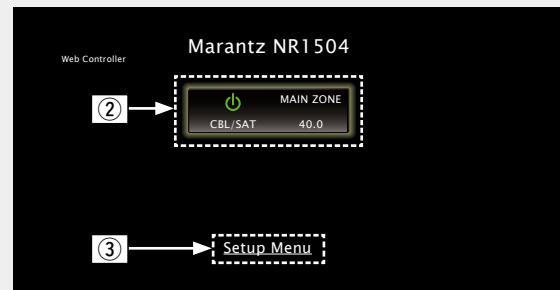

- ② Click when you select the zone to operate. (Example 1)
- ③ Click when you operate the setup menu. (Example 2)

**6** Operate.

[Example 1] MAIN ZONE control screen

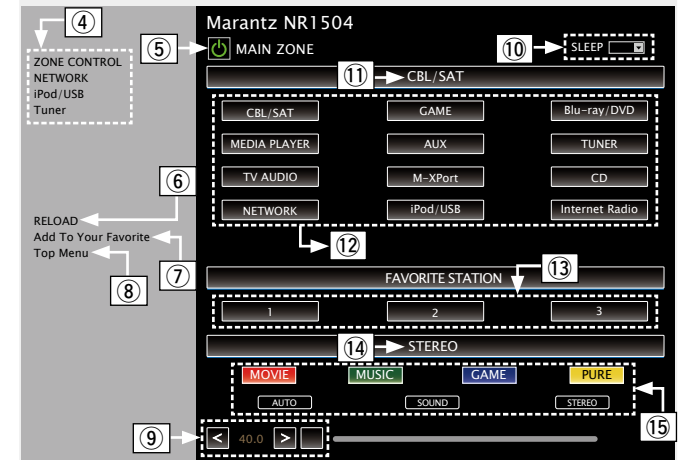

- ④ Click the menu item from which you want to make settings.
- ⑤ Click when you perform the power on/off function of the unit.
- ⑥ Click when you update to the latest information.  
If changes are made during normal operation, then be sure to click this button to refresh the information with the latest status.
- ⑦ Click to add a setting to “Favorites” in your browser.  
We recommend registering the setting screens for the different zones in the browser’s favorites so as not to accidentally perform menu operations for zones you do not intend to operate.
- ⑧ Click to return to the top menu.
- ⑨ To adjust the main volume, click “<”, “>”, or the volume display.
- ⑩ Click “v” to set the sleep timer function.
- ⑪ Displays the name of the selected input source.
- ⑫ Click a button to change the input source.
- ⑬ Callback your favorite content.
- ⑭ Displays the sound mode.
- ⑮ The sound mode switches when you click the button.



**[Example 2]** Setup menu screen

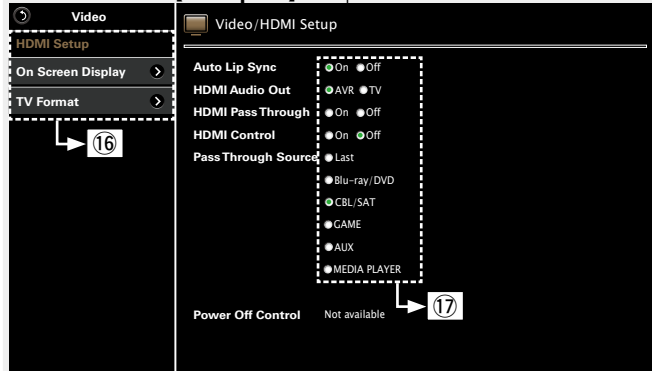

- 16 Click the menu item from which you want to make settings.  
The display on the right becomes the individual setting screens.
- 17 Click an item to make a setting.

**[Example 3]** Network audio operating screen

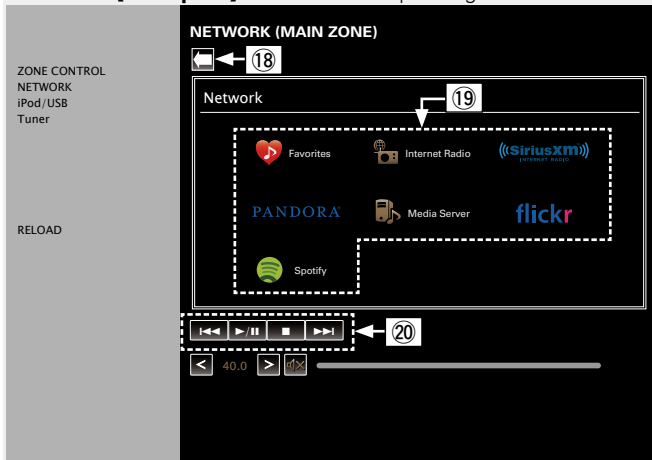

- 18 Click to return to the previous screen.
- 19 Click the content you want to operate.
- 20 Use to operate content.

## Dual backup memory function

The unit stores settings information in nonvolatile memory even when the main power supply is turned off. Using the Dual Backup Memory function, you can write settings information to another memory area to back up saved settings for recovery anytime as needed. Remembering set details (Backup).

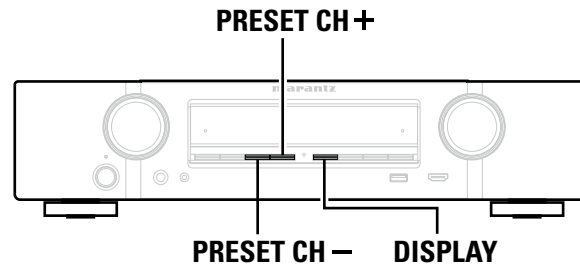

### Remembering set details (Backup)

Set the unit in the state you want remembering, and press and hold **PRESET CH -** and **PRESET CH +** for at least 3 seconds.

"MEMORY SAVING" is shown in the display, and the setting details are remembered.

#### NOTE

- The volume is not remembered.
- If remembered details are overwritten, the previously remembered contents are deleted.

### Recalling remembered details (Recovery)

Press and hold **PRESET CH +** and **DISPLAY** together for at least 3 seconds.

"MEMORY LOAD" is shown in the display, and the remembered details are recalled.

#### NOTE

- If there is no remembered data, "NO BACKUP" is shown in the display, and no remembered details are recalled.
- As the volume cannot be recalled, it returns to the factory setting volume.

## Panel lock function

To prevent accidental operation of this unit, you can disable operation of the buttons on the front panel.

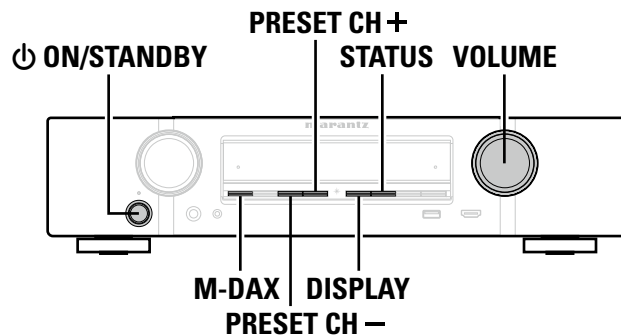

### ❑ Disabling all key button operations

- 1** Press **ON/STANDBY** while you press and hold **M-DAX** and **DISPLAY** with the unit in standby mode.
- 2** Press **PRESET CH -** or **PRESET CH +** to select “FP/VOL LOCK On”.
- 3** Press **STATUS** to enter the setting.  
All button operations except **ON/STANDBY** are disabled.

### ❑ Disabling all button operations except VOLUME

- 1** Press **ON/STANDBY** while you press and hold **M-DAX** and **DISPLAY** with the unit in standby mode.
- 2** Press **PRESET CH -** or **PRESET CH +** to select “FP/LOCK On”.
- 3** Press **STATUS** to enter the setting.  
All button operations except **ON/STANDBY** and **VOLUME** are disabled.

### ❑ Canceling the Panel lock function

- 1** Press **ON/STANDBY** while you press and hold **M-DAX** and **DISPLAY** with the unit in standby mode.
- 2** Press **PRESET CH -** or **PRESET CH +** to select “FP/LOCK \*Off”.  
(\* The currently set mode.)
- 3** Press **STATUS** to enter the setting.  
The Panel lock function is canceled.



Even when the Panel lock function is set, you can operate the unit using the remote control unit.

## Remote lock function

- When not connecting an IR receiver, disable the Remote lock function. When the function is enabled, you can not perform operations with the remote control unit.
- By default, this function is disabled.

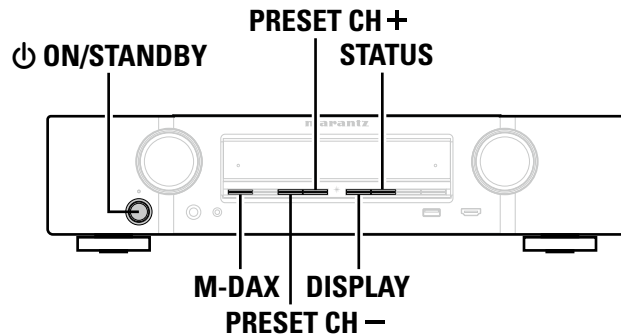

### ❑ Disabling the sensor function of the remote control unit

- 1** When the main unit is in standby mode, press **ON/STANDBY** while holding down **M-DAX** and **DISPLAY** on the main unit.
- 2** Press **PRESET CH -** or **PRESET CH +** to select “RC LOCK On”.
- 3** Press **STATUS** to enter the setting.  
The infrared light receiving function is disabled.

### ❑ Enabling the remote sensor function

- 1** When the main unit is in standby mode, press **ON/STANDBY** while holding down **M-DAX** and **DISPLAY** on the main unit.
- 2** Press **PRESET CH -** or **PRESET CH +** to select “RC LOCK \*Off”.  
(\* The currently set mode.)
- 3** Press **STATUS** to enter the setting.  
The infrared light receiving function on the main unit is enabled.

## Various memory functions

### Personal memory plus function

This function sets the settings (input mode, sound mode, HDMI output mode, MultEQ®, Dynamic EQ, audio delay etc.) last selected for the individual input sources.



The surround parameters, tone control settings and the volumes of the different speakers are stored for the individual sound modes.

### Last function memory

This function stores the settings which were made before going into the standby mode.





When the power is turned back on, the settings are restored.





# How to make detailed settings

## Menu map

For menu operation, connect a TV to this unit and display the menu on the TV screen. For menu operations, see the following page.

By default, this unit has recommended settings defined. You can customize this unit based on your existing system and your preferences.

Setting items	Detailed items	Description	Page
 Audio	<b>Dialog Level</b>	Sets the output level to clarify the dialogue output from the center channel.	<a href="#">94</a>
	<b>Subwoofer Level</b>	This setting adjusts the volume level for the subwoofer.	<a href="#">94</a>
	<b>Surr.Parameter</b>	Adjusts surround sound parameters.	<a href="#">94</a>
	<b>Tone</b>	Adjusts the tonal quality of the sound.	<a href="#">95</a>
	<b>M-DAX</b>	Expands the low and high frequency components of compressed audio content such as MP3 files to enable richer audio playback.	<a href="#">96</a>
	<b>Audio Delay</b>	Compensates for incorrect timing between video and audio.	<a href="#">96</a>
	<b>Volume</b>	Set the MAIN ZONE (room where the unit is located) volume setting.	<a href="#">96</a>
	<b>Audyssey</b>	Makes Audyssey MultEQ®, Audyssey Dynamic EQ® and Audyssey Dynamic Volume® settings.	<a href="#">97</a>
	<b>Manual EQ</b>	Uses the graphic equalizer to adjust the tone of each speaker.	<a href="#">98</a>
 Video	<b>HDMI Setup</b>	Makes settings for HDMI video/audio output.	<a href="#">100</a>
	<b>On Screen Disp.</b>	Select the on-screen display user interface preferences.	<a href="#">101</a>
	<b>TV Format</b>	Set the video output signal format for the TV you are using.	<a href="#">101</a>
 Inputs	<b>Input Assign</b>	Changes input connector assignment.	<a href="#">103</a>
	<b>Source Rename</b>	Changes the display name for this source.	<a href="#">105</a>
	<b>Hide Sources</b>	Remove from the display input sources that are not used.	<a href="#">105</a>
	<b>Source Level</b>	Adjusts the playback level of the audio input.	<a href="#">105</a>
	<b>Input Select</b>	Sets the audio input mode and decode mode.	<a href="#">105</a>
 Speakers	<b>Audyssey® Setup</b>	The acoustic characteristics of the connected speakers and listening room are measured and the optimum settings are made automatically.	<a href="#">23</a>
	<b>Manual Setup</b>	Perform when setting the speakers manually or when changing settings made in Audyssey® Setup.	<a href="#">107</a>

Setting items	Detailed items	Description	Page	
 Network	<b>Information</b>	Display network information.	<a href="#">111</a>	
	<b>IP Control</b>	Enables network communication in standby power mode.	<a href="#">111</a>	
	<b>Friendly Name</b>	The Friendly Name is the name of this unit displayed on the network. You can change the Friendly Name according to your preferences.	<a href="#">111</a>	
	<b>Settings</b>	Make settings for wired LAN.	<a href="#">112</a>	
	<b>Diagnostics</b>	Used to check the network connection.	<a href="#">113</a>	
	<b>Maintenance Mode</b>	Use when receiving maintenance from a Marantz service engineer or custom installer.	<a href="#">113</a>	
	 General	<b>Language</b>	Sets the language for display the menu on the TV screen.	<a href="#">115</a>
<b>Auto Standby</b>		When you do not perform any operation on this unit with no audio or video input for a specified time, this unit automatically enters the standby mode. Before it enters the standby mode, "Auto Standby" is displayed on the display of this unit and the menu screen.	<a href="#">115</a>	
<b>Front Display</b>		Makes settings related to the display on this unit.	<a href="#">115</a>	
<b>Information</b>		Show information about receiver settings, input signals, etc.	<a href="#">116</a>	
<b>Usage Data</b>		Selects whether or not to send anonymous usage data to Marantz.	<a href="#">117</a>	
<b>Firmware</b>		Set whether or not to check for firmware update, update the firmware, and display update and upgrade notifications.	<a href="#">117</a>	
<b>Setup Lock</b>		Protect settings from inadvertent changes.	<a href="#">118</a>	
 Setup Assistant		Perform the installation, connection, and setup procedures to prepare the unit for operation following guidance from the setup section of this manual.		 7

# Examples of menu screen displays

Typical examples are described below.

## [Example 1]

### Menu selection screen (Top menu)

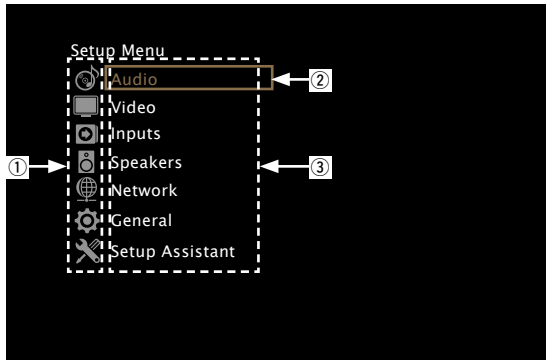

- ① List of GUI menu setup icons
- ② Currently selected setup item
- ③ List of GUI menu setup items

Press  $\Delta$ / $\nabla$  to select "Audio"  
and then press  $\triangleright$ .  
(Or press ENTER.)

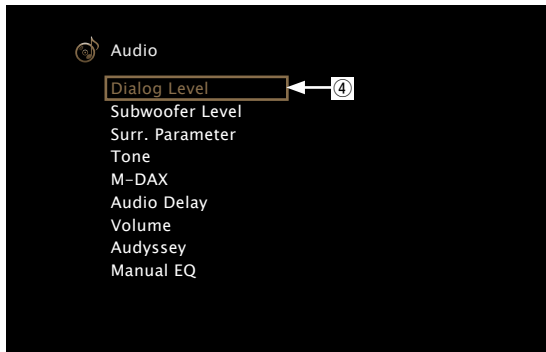
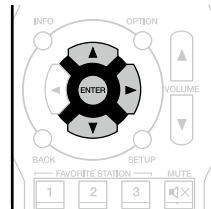

- ④ Selected setup item

## [Example 2]

### Audyssey® Setup screen (with illustration)

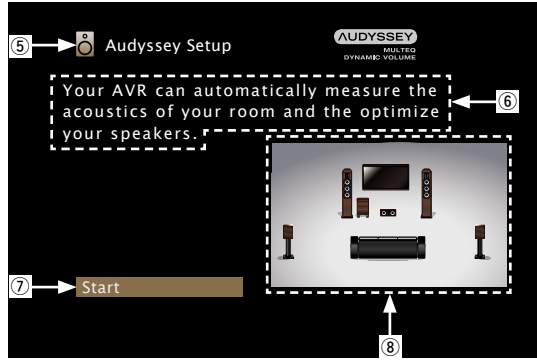





- ⑤ Currently selected setup icon
- ⑥ Operation guidance text
- ⑦ Selected setup item
- ⑧ Illustration

### NOTE

When the menu is operated on a computer's resolution (e.g. VGA) or during playback of certain 3D video content, the playback image switches to the menu screen image.

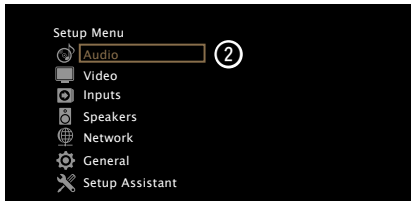
# Examples of menu and front display

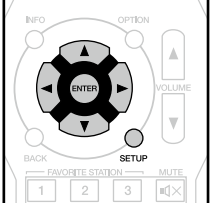
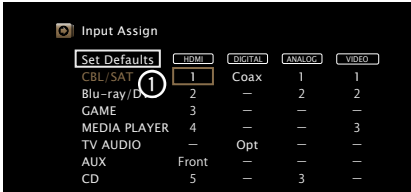
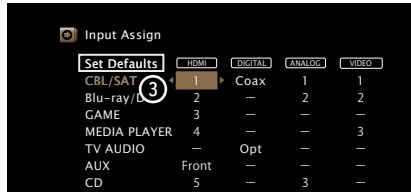
Below we describe typical examples of displays on the TV screen and on the set's display window.

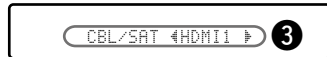
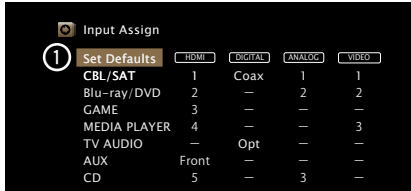
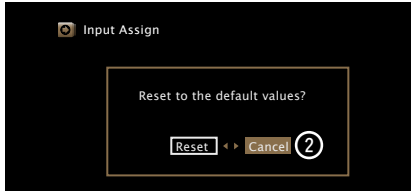
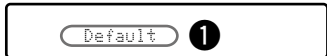
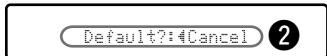
	Menu display	Front display	Description
<b>Top menu display</b>			<ol style="list-style-type: none"> <li>1 Press <b>SETUP</b> to display the menu screen.</li> <li>2 TV screen: Displays the selected line. Display: Displays the selected item. <ul style="list-style-type: none"> <li>• Use <math>\Delta</math>/<math>\nabla</math> to move to the item you want to set.</li> </ul> </li> </ol> 
<b>Display when changing settings</b>	 <p>Press <b>ENTER</b>.</p> 	 <p>Press <b>ENTER</b>.</p> 	<ol style="list-style-type: none"> <li>1 TV screen: Displays the selected line. Display: Displays the selected item. <ul style="list-style-type: none"> <li>• Use <math>\Delta</math>/<math>\nabla</math> to move to the item you want to set.</li> </ul> </li> <li>2 Press <b>ENTER</b> to set to the mode in which the setting can be made.</li> <li>3 ◀ ▶ is displayed at the sides of items whose setting can be changed. Use ◀▶ to change to the desired setting.</li> </ol>
<b>Display when returning to the settings in effect at time of purchase</b>	 <p>Press <b>ENTER</b>.</p> 	 <p>Press <b>ENTER</b>.</p> 	<ol style="list-style-type: none"> <li>1 Press <math>\Delta</math> to select "Set Defaults" (TV screen) or "Default" (Display), then press <b>ENTER</b>.</li> <li>2 Press ◀ to select "Reset", then press <b>ENTER</b>.</li> </ol>

# Inputting characters

On this unit, you can change the name displayed on the following screens to the names that you prefer.

- Text Search (☞ page 65)
- Preset Name (☞ page 44)
- Source Rename (☞ page 105)
- Friendly Name (☞ page 111)
- Character input for the network functions (☞ page 47, 55, 57, 61, 63, 112)

## Keyboard screen

Select a character on the TV screen to input characters.

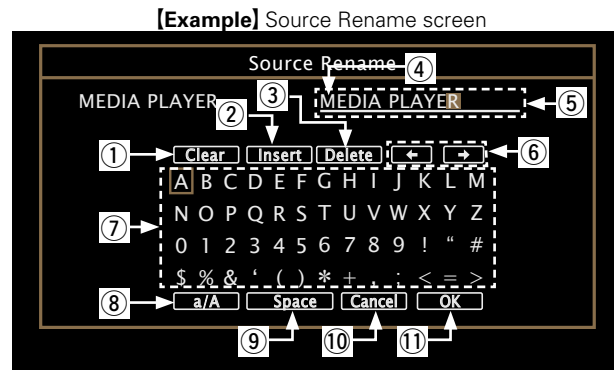

- ① Clear key
- ② Insert key
- ③ Delete key
- ④ Cursor
- ⑤ Character input section
- ⑥ Cursor keys
- ⑦ Keyboard section
- ⑧ Uppercase and lowercase switch key
- ⑨ Space key
- ⑩ Cancel key
- ⑪ OK key

## Input method

- 1 Display the screen for inputting characters (☞ page 89 “Menu map”).

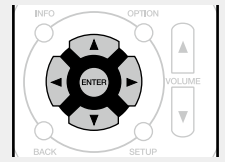

- 2 Select a character to be changed.
  - ① Use  $\Delta \nabla \triangleleft \triangleright$  to select  $\leftarrow$  or  $\rightarrow$ .
  - ② Press **ENTER** to place the cursor at the character to be changed.  
Each time **ENTER** is pressed, the cursor moves by one character.

- 3 Select a character to be input with  $\Delta \nabla \triangleleft \triangleright$  then press **ENTER**.

- The types of characters that can be input are as shown below.

### [Upper case characters/Numbers/Symbols]

ABCDEFGHIJKLMNOPQRSTUVWXYZ

0123456789

! " # \$ % & ' ( ) \* + , ; < = >

### [Lower case characters/Numbers/Symbols]

abcdefghijklmnopqrstuvwxyz

0123456789

. @ - \_ / : ~ ? [ \ ] ^ ' { | }

- 4 Repeat steps 2 and 3 to change the name.

- 5 Use  $\Delta \nabla \triangleleft \triangleright$  to select **OK**, then press **ENTER**.



Make audio-related settings.

## Menu operation

### 1 Press **SETUP**.

The menu is displayed on the TV screen.

### 2 Use $\Delta$ / $\nabla$ to select the menu to be set or operated.

### 3 Press **ENTER** or $\blacktriangleright$ to enter the setting.

- To return to the previous item, press  $\blacktriangleleft$  or **BACK**.
- Exiting the Menu, press **SETUP** while the menu is displayed. The menu display disappears.

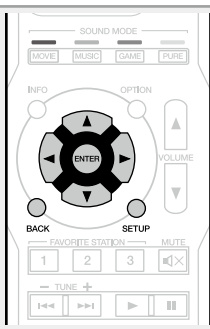

## Items that can be set with the "Audio" procedure

**Dialog Level** ([page 94](#))

**Subwoofer Level** ([page 94](#))

**Surr.Parameter** ([page 94](#))

**Tone** ([page 95](#))

**M-DAX** ([page 96](#))

**Audio Delay** ([page 96](#))

**Volume** ([page 96](#))

**Audyssey** ([page 97](#))

**Manual EQ** ([page 98](#))



## Dialog Level

Default settings are underlined.

Sets the output level to clarify the dialogue output from the center channel.

Setting items	Setting details
Level	<u>-12dB – +12dB (0dB)</u>

## Subwoofer Level

Default settings are underlined.

This setting adjusts the volume level for the subwoofer.

Setting items	Setting details
<b>Subwoofer</b> Turn subwoofer output on and off.	<b>On</b> : The subwoofer is used. <b>Off</b> : The subwoofer is not used. <div style="text-align: center;"><b>NOTE</b></div> This can be set when the sound mode is "DIRECT" and "PURE DIRECT" ( <a href="#">page 72</a> ) and the "Subwoofer Mode" ( <a href="#">page 109</a> ) is "LFE+Main".
<b>Subwoofer Level</b> This setting adjusts the volume level for the subwoofer.	<u>-12dB – +12dB (0dB)</u>

## Surr.Parameter



Default settings are underlined.





You can adjust the surround audio sound field effects to match your preferences.

The items (parameters) that can be adjusted depend on the signal being input and the currently set sound mode. For details on the adjustable parameters, see "Sound modes and surround parameters" ([page 126](#)).

### NOTE

- Some setting items cannot be set while playback is stopped. Make the settings during playback.
- When the sound mode is "PURE DIRECT", you cannot set the surround parameters.

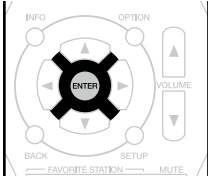

Setting items	Setting details
<b>Home Theater EQ</b> Gently softens the upper treble range of movie soundtracks to reduce possible harshness and improve clarity.	<b>On</b> : "Home Theater EQ" is used. <b>Off</b> : "Home Theater EQ" is not used.
<b>Loudness Mngmt</b> This can be set in the Dolby TrueHD mode. This sets whether to output as specified in "Dynamic Comp." or output directly without compressing the dynamic range of audio recorded in the disc.	<b>On</b> : Outputs using the settings made in "Dynamic Comp." and "Dialogue Normalization" ( <a href="#">page 116</a> ) are enabled. <b>Off</b> : "Dynamic Comp." settings and "Dialogue Normalization" are disabled, and the signals on the disk are output as is.
<b>Dynamic Comp.</b> Compress dynamic range (difference between loud and soft sounds).	<b>Auto</b> : Automatic dynamic range compression on/off control according to source. <b>Low / Medium / High</b> : These set the compression level. <b>Off</b> : Dynamic range compression is always off.  You can set "Auto" only for the Dolby TrueHD source.
<b>Low Frequency</b> Adjust the low-frequency effects level (LFE).	<u>-10dB – 0dB</u>  For proper playback of the different sources, we recommend setting to the values below. <ul style="list-style-type: none"> <li>• Dolby Digital sources : 0dB</li> <li>• DTS movie sources : 0dB</li> <li>• DTS music sources : -10dB</li> </ul>

Setting items	Setting details
<p><b>Center Image</b> Distributes the dialogue output from the center channel to the front left and right channels and widens the sound image in the front. You can set this when the sound mode is set to DTS NEO:6.</p>	<p><b>0.0 – 1.0 (0.3)</b></p> <p> The smaller the value, the more dialogue is concentrated on the center channel. The larger the value, the more dialogue is distributed to front left and right channels, and the more the sound image widens in the front.</p>
<p><b>Panorama</b> Assign front L/R signals to also go to the surround channels for wider sound. You can set this when the sound mode is Dolby PLII in the "Music" mode.</p>	<p><b>On</b> : Set. <b>Off</b> : Do not set.</p>
<p><b>Dimension</b> Shift sound image center to front or rear to adjust playback balance. You can set this when the sound mode is Dolby PLII in the "Music" mode.</p>	<p><b>0 – 6 (3)</b></p> <p> As you set a smaller number, the surround sound field shifts backward; as you set a larger number, the surround sound field shifts forward.</p>
<p><b>Center Width</b> Distributes the dialogue output from the center channel to left and right channels and widens the sound image in the front. You can set this when the sound mode is Dolby PLIIx in the "Music" mode.</p>	<p><b>0 – 7 (3)</b></p> <p> The smaller the value, the more dialogue is concentrated on the center channel. The larger the value, the more dialogue is distributed to front left and right channels, and the more the sound image widens in the front.</p>
<p><b>Set Defaults</b> The "Surr.Parameter" settings are returned to the default settings.</p>	<p><b>Reset</b> : Reset to the defaults. <b>Cancel</b> : Do not reset to the defaults.</p> <p> When you select "Set Defaults" and press <b>ENTER</b>, the "Reset all surround parameters to the factory defaults?" prompt is displayed. Select either "Reset" or "Cancel", and press <b>ENTER</b>.</p> 

## Tone

Default settings are underlined.

Adjust the tonal quality of the sound.

Setting items	Setting details
<p><b>Tone Control</b> Set the tone control function to "On" and "Off".</p>	<p><b>On</b> : Allow tone adjustment (bass, treble). <b>Off</b> : Playback without tone adjustment.</p> <p> "Tone Control" can be set when "Dynamic EQ" (<a href="#">page 97</a>) is set to "Off".</p> <p><b>NOTE</b></p> <ul style="list-style-type: none"> <li>• The tone cannot be adjusted in the "DIRECT" and "PURE DIRECT" mode.</li> <li>• The default setting differs depending on the sound mode.</li> </ul>
<p><b>Bass</b> Adjust bass.</p>	<p><b>-6dB – +6dB</b></p> <p></p> <ul style="list-style-type: none"> <li>• "Bass" can be set when the menu "Tone Control" setting is "On".</li> <li>• The default setting differs depending on the sound mode.</li> </ul>
<p><b>Treble</b> Adjust treble.</p>	<p><b>-6dB – +6dB</b></p> <p></p> <ul style="list-style-type: none"> <li>• "Treble" can be set when the menu "Tone Control" setting is "On".</li> <li>• The default setting differs depending on the sound mode.</li> </ul>

## M-DAX

Compressed audio formats such as MP3, WMA (Windows Media Audio) and MPEG-4 AAC reduce the amount of data by eliminating signal components that are hard for the human ear to hear. The “M-DAX” function generates the signals eliminated upon compression, restoring the sound to conditions near those of the original sound before compression. It also restores the original bass characteristics for a rich and expanded tonal range.

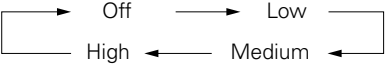
Setting items	Setting details
<b>Mode</b> Set the mode for “M-DAX”.	<p><b>High</b> : Optimized mode for compressed sources with very weak highs (64 kbps and under).</p> <p><b>Medium</b> : Apply suitable bass and treble boost for all compressed sources (96 kbps and under).</p> <p><b>Low</b> : Optimized mode for compressed sources with normal highs (96 kbps and over).</p> <p><b>Off</b> : Do not use “M-DAX”.</p> <p></p> <ul style="list-style-type: none"> <li>This item can be set with analog signals or PCM signal (Sample Rate = 44.1/48 kHz) is input.</li> <li>“M-DAX” settings are stored for each input source.</li> <li>When set to “Off”, the M-DAX indicator on the front panel switches off.</li> <li>This cannot be set when the sound mode is set to “DIRECT” or “PURE DIRECT”.</li> <li>This can also be set by pressing <b>M-DAX</b>. Each time <b>M-DAX</b> is pressed, the setting is changed as shown below.</li> </ul> <div style="text-align: center;">  <pre>                     graph LR                         Off --&gt; Low                         Low --&gt; Medium                         Medium --&gt; High                         High --&gt; Off                     </pre> </div>

## Audio Delay

Default settings are underlined.

While viewing video, manually adjust the time to delay audio output so that the video and audio are synchronized.

### Setting details

**0ms – 200ms**



- This item can be set within the range of 0 to 100 ms when “Auto Lip Sync” ([page 100](#)) is set to “On” and when a TV compatible with Auto Lip Sync is connected.
- Store “Audio Delay” for each input source.

## Volume

Default settings are underlined.

Set the MAIN ZONE (room where the unit is located) volume setting.

Setting items	Setting details
<b>Scale</b> Set how volume is displayed.	<p><b>0 – 98</b> : Display in the range 0 (Min) to 98.</p> <p><b><u>-79.5dB – 18.0dB</u></b> : Display --dB (Min), in the range -79.5 dB to 18.0 dB.</p> <p></p> <p>The “Scale” setting is applied also to the “Limit” and “Power On Level” display method.</p>
<b>Limit</b> Make a setting for maximum volume.	<p><b>60 (-20dB) / 70 (-10dB) / 80 (0dB)</b></p> <p><b>Off</b> : Do not set a maximum volume.</p>
<b>Power On Level</b> Define the volume setting that is active when the power is turned on.	<p><b>Last</b> : Use the memorized setting from the last session.</p> <p><b>Mute</b> : Always use the muting on condition when power is turned on.</p> <p><b>1 – 98 (-79dB – 18dB)</b> : The volume is adjusted to the set level.</p>
<b>Mute Level</b> Set the amount of attenuation when muting is on.	<p><b>Full</b> : The sound is muted entirely.</p> <p><b>-40dB</b> : The sound is attenuated by 40 dB down.</p> <p><b>-20dB</b> : The sound is attenuated by 20 dB down.</p>

# Audyssey

Default settings are underlined.

Set Audyssey MultEQ®, Audyssey Dynamic EQ® and Audyssey Dynamic Volume®. These can be selected after Audyssey® Setup has been performed. For additional information on Audyssey technology, please see [page 130](#).



**NOTE**

- If you have not performed Audyssey® Setup, or if you change the speaker settings after performing Audyssey® Setup, you may not be able to select Dynamic EQ/Dynamic Volume. In this case, either perform Audyssey® Setup over again or perform “Restore...” ([page 29](#)) to return to the settings after Audyssey® Setup was run.
- When HD Audio for which the sampling frequency exceeds 96 kHz is played back, the “Audyssey” cannot be set.

Setting items	Setting details
<b>MultEQ®</b> MultEQ® compensates for both time and frequency characteristics of the listening area based on Audyssey® Setup measurement results. Selection is done from three types of compensation curves. We recommend the “Audyssey” setting. MultEQ® is the prerequisite function for Dynamic EQ and Dynamic Volume.	<p><b>Audyssey</b> : Optimize the frequency response of all speakers.</p> <p><b>Audyssey Byp. L/R</b> : Optimize frequency response of speakers except front L and R speakers.</p> <p><b>Audyssey Flat</b> : Optimize frequency response of all speakers to flat response.</p> <p><b>Manual EQ</b> : Apply frequency response set with “Manual EQ” (<a href="#">page 98</a>).</p> <p><b>Off</b> : Turn “MultEQ®” equalizer off.</p> <p> “Audyssey”, “Audyssey Byp. L/R” and “Audyssey Flat” can be selected after Audyssey® Setup has been performed. “Audyssey” is automatically selected after performing Audyssey® Setup. When “Audyssey”, “Audyssey Byp. L/R” or “Audyssey Flat” is selected, <b>AUDYSSEY</b> illuminates.</p> <p><b>NOTE</b> When using headphones, “MultEQ®” is automatically set to “Off”.</p>



“MultEQ®”, “Dynamic EQ” and “Dynamic Volume” settings are stored for each input source.



Setting items	Setting details
<b>Dynamic EQ</b> Solves the problem of deteriorating sound quality as volume is decreased by taking into account human perception and room acoustics. Works with MultEQ®.	<p><b>On</b> : Use Dynamic EQ.</p> <p><b>Off</b> : Do not use Dynamic EQ.</p> <p> <b>AUDYSSEY</b> is displayed when set to “On”.</p> <p><b>NOTE</b> When the menu “Dynamic EQ” setting is “On”, it is not possible to do “Tone Control” (<a href="#">page 95</a>) adjustment.</p>
<b>Reference Level Offset</b> Audyssey Dynamic EQ® is referenced to the standard film mix level. It makes adjustments to maintain the reference response and surround envelopment when the volume is turned down from 0 dB. However, film reference level is not always used in music or other non-film content. Dynamic EQ Reference Level Offset provides three offsets from the film level reference (5 dB, 10 dB, and 15 dB) that can be selected when the mix level of the content is not within the standard. Recommended setting levels are shown at right.	<p><b>0dB</b> (Film Ref) : This is the default setting and should be used when listening to movies.</p> <p><b>5dB</b> : Select this setting for content that has a very wide dynamic range, such as classical music.</p> <p><b>10dB</b> : Select this setting for jazz or other music that has a wider dynamic range. This setting should also be selected for TV content as that is usually mixed at 10 dB below film reference.</p> <p><b>15dB</b> : Select this setting for pop/rock music or other program material that is mixed at very high listening levels and has a compressed dynamic range.</p> <p> Setting is enabled when “Dynamic EQ” is “On” (<a href="#">page 97</a>).</p>
<b>Dynamic Volume</b> Solves the problem of large variations in volume level between TV, movies and other content (between quiet passages and loud passages, etc.) by automatically adjusting to the user’s preferred volume setting.	<p><b>Heavy</b> : Most adjustment to softest and loudest sounds.</p> <p><b>Medium</b> : Medium adjustment to loudest and softest sound.</p> <p><b>Light</b> : Least adjustment to loudest and softest sounds.</p> <p><b>Off</b> : Do not use “Dynamic Volume”.</p> <p></p> <ul style="list-style-type: none"> <li>• <b>AUDYSSEY</b> is displayed when set to “Heavy”, “Medium” or “Light”.</li> <li>• If “Dynamic Volume” is set to “Yes” in “Audyssey® Setup” (<a href="#">page 27</a>), the setting is automatically changed to “Medium”.</li> </ul>

## Manual EQ

**Default settings are underlined.**

Use the 9 band graphic equalizer to adjust the tone of each speaker.

“Manual EQ” can be set when “MultEQ<sup>®</sup>” setting ([page 97](#)) is “Manual EQ”.

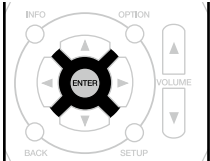
Setting items	Setting details
<b>Speaker Select.</b> Select whether to adjust tones for individual speakers or for all speakers.	<b>All</b> : Adjust the tone of all speakers together. <b>Left/Right</b> : Adjust the tone of left and right speakers together. <b>Each</b> : Adjust the tone of each speaker.
<b>Adjust EQ</b> Adjust tonal balance for each frequency band. Adjust the speaker selected in “Speaker Select.”.	① Select the speaker. <ul style="list-style-type: none"> <li>• Select the speakers you want to adjust when “Left/Right” or “Each” is selected.</li> </ul> ② Select the adjustment frequency band. <b>63Hz / 125Hz / 250Hz / 500Hz / 1kHz / 2kHz / 4kHz / 8kHz / 16kHz</b> ③ Adjust the level. <b>-20.0dB – +6.0dB (0.0dB)</b>
<b>Curve Copy</b> Copy “Audyssey Flat” ( <a href="#">page 97</a> ) curve from MultEQ <sup>®</sup> .	<b>Yes</b> : Copy. <b>No</b> : Do not copy.  <ul style="list-style-type: none"> <li>• “Curve Copy” is displayed after Audyssey<sup>®</sup> Setup has been performed.</li> <li>• When you select “Curve Copy” and press <b>ENTER</b>, the “Copy “Audyssey Flat?”” prompt is displayed. Select either “Yes” or “No”, and press <b>ENTER</b>.</li> </ul>
<b>Set Defaults</b> The “Manual EQ” settings are returned to the default settings.	<b>Reset</b> : Reset to the defaults. <b>Cancel</b> : Do not reset to the defaults.  When you select “Set Defaults” and press <b>ENTER</b> , the “Reset to the default values?” prompt is displayed. Select either “Reset” or “Cancel”, and press <b>ENTER</b> . 



Make video-related settings.

## Menu operation

### 1 Press **SETUP**.

The menu is displayed on the TV screen.

### 2 Use $\Delta$ / $\nabla$ to select the menu to be set or operated.

### 3 Press **ENTER** or $\triangleright$ to enter the setting.

- To return to the previous item, press  $\triangleleft$  or **BACK**.
- Exiting the Menu, press **SETUP** while the menu is displayed. The menu display disappears.

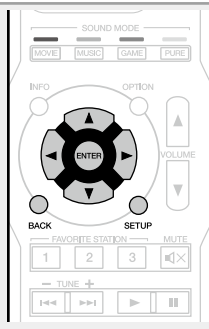

## Items that can be set with the "Video" procedure

**HDMI Setup** (👉 [page 100](#))

**On Screen Disp.** (👉 [page 101](#))



**TV Format** (👉 [page 101](#))

## HDMI Setup

Default settings are underlined.

Make settings for HDMI video/audio output.

Setting items	Setting details
<b>Auto Lip Sync</b> Make automatic compensation for timing shift in audio and video output.	<b>On</b> : Compensated. <b>Off</b> : Not compensated.
<b>HDMI Audio Out</b> Select HDMI audio output device.	<b>AVR</b> : Play back through speakers connected to the unit. <b>TV</b> : Play back through TV connected to the unit.  <ul style="list-style-type: none"> <li>When the HDMI control function is activated, priority is given to the TV audio setting (<a href="#">page 83</a> "HDMI control function").</li> <li>When the power of this unit is on and "HDMI Audio Out" is set to "TV", audio is output as 2-channel from the HDMI OUT connector.</li> </ul>
<b>HDMI Pass Through</b> Selects how the AV receiver will pass HDMI signals to the HDMI output in standby power mode.	<b>On</b> : Passes the selected HDMI input through the AV receiver's HDMI output when the AV receiver is in standby power mode. <b>Off</b> : No HDMI signals are passed through the AV receiver's HDMI output in standby power mode. <div style="background-color: #f08080; border-radius: 10px; padding: 2px; display: inline-block; margin-top: 10px;"><b>NOTE</b></div> <b>When "HDMI Pass Through" is set to "On", it consumes more standby power.</b> If you are not using this unit for an extended period, it is recommended that you unplug the power cord from the power outlet.

Setting items	Setting details
<b>HDMI Control</b> You can link operations with devices connected to HDMI and compatible with HDMI Control.	<b>On</b> : Use HDMI control function. <b>Off</b> : Do not use HDMI control function.  <ul style="list-style-type: none"> <li>When a device that is not compatible with the HDMI control function is connected, set "HDMI Control" to "Off".</li> <li>Please consult the operating instructions for each connected device to check the settings.</li> <li>Refer to "HDMI control function" (<a href="#">page 83</a>) for more information about the HDMI control function.</li> </ul> <div style="background-color: #f08080; border-radius: 10px; padding: 2px; display: inline-block; margin-top: 10px;"><b>NOTE</b></div> <ul style="list-style-type: none"> <li><b>When "HDMI Control" is set to "On", it consumes more standby power.</b> If you are not using this unit for an extended period, it is recommended that you unplug the power cord from the power outlet.</li> <li>The HDMI control function controls operations of a TV that is compatible with the HDMI control function. Make sure that the TV and HDMI are connected when you perform HDMI control.</li> <li>If the "HDMI Control" settings have been changed, always reset the power to connected devices after the change.</li> </ul>
<b>Pass Through Source</b> The AV receiver will "pass through" the sources HDMI signal when in standby.	<b>Last</b> : Choose this option to "pass through" the last used HDMI input video source. <b>CBL/SAT / DVD / Blu-ray / GAME / AUX / MEDIA PLAYER / CD</b> : Choose one of these HDMI sources to be passed through when the AV receiver is in standby.  "Pass Through Source" can be set when "HDMI Control" is set to "On" or "HDMI Pass Through" is set to "On".
<b>Power Off Control</b> Links the power standby of this unit to external devices.	<b>All</b> : If power to a connected TV is turned off independently of the input source, power to this unit is automatically set to standby. <b>Video</b> : When the TV is turned off with one of "HDMI" or "VIDEO" ( <a href="#">page 103, 104</a> ) assigned for the CBL/SAT / DVD / Blu-ray / GAME / AUX / MEDIA PLAYER / CD / TV AUDIO input source on this unit, power to this unit is automatically set to standby. <b>Off</b> : This unit does not link with power to a TV.  "Power Off Control" can be set when "HDMI Control" is set to "On".

## On Screen Disp.

Default settings are underlined.

Select the on-screen display user interface preferences.

Setting items	Setting details
<b>Volume</b> Sets where to display the master volume level.	<u>Bottom</u> : Display at the bottom. <u>Top</u> : Display at the top. <u>Off</u> : Turn display off.  When the master volume display is hard to see when superimposed text (closed captioning) or movie subtitles are present, set to "Top".
<b>Info</b> Displays status of operation temporarily when the sound mode is changed, or input source is switched. You can set whether or not to show each of these status displays.	<u>On</u> : Turn display on. <u>Off</u> : Turn display off.
<b>Now Playing</b> Sets how long each menu is displayed when the input source is "NETWORK", "iPod/USB" or "TUNER".	<u>Always On</u> : Show display continuously. <u>Auto Off</u> : Show display for 30 seconds after operation.

## TV Format

Default settings are underlined.

Set the video signal format to be output for the TV you are using.

Setting items	Setting details
<b>Format</b>	<u>NTSC</u> : Select NTSC output. <u>PAL</u> : Select PAL output.  "Format" can also be set by the following procedure. However, the menu screen is not displayed. <ol style="list-style-type: none"> <li>1. Press and hold the main unit's <b>PRESET CH -</b> and <b>STATUS</b> for at least 3 seconds.                "V.Format:&lt;NTSC&gt;" appears on the display.</li> <li>2. Use the main unit's <b>PRESET CH -</b> or <b>PRESET CH +</b> and set the video signal format.</li> <li>3. Press the main unit's <b>STATUS</b> to complete the setting.</li> </ol> <div style="background-color: #f08080; border-radius: 5px; padding: 2px; display: inline-block; margin-top: 10px;"><b>NOTE</b></div> When a format other than the video format of the connected TV is set, the picture will not be displayed properly.





Perform settings related to input source playback.

- You do not have to change the settings to use the unit. Make settings when needed.

## Menu operation

### 1 Press **SETUP**.

The menu is displayed on the TV screen.

### 2 Use $\Delta$ / $\nabla$ to select the menu to be set or operated.

### 3 Press **ENTER** or $\triangleright$ to enter the setting.

- To return to the previous item, press  $\triangleleft$  or **BACK**.
- Exiting the Menu, press **SETUP** while the menu is displayed. The menu display disappears.

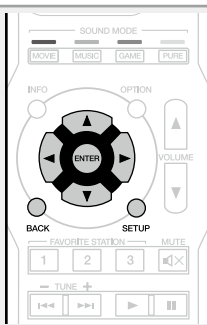

## Important information

### □ About the display of input sources

In this section, the configurable input sources for each item are shown as follows.



#### NOTE

Input sources that have been set to "Hide" at "Hide Sources" ([page 105](#)) cannot be selected.

## Items that can be set with the "Inputs" procedure

Input Assign ([page 103](#))

Source Rename ([page 105](#))

Hide Sources ([page 105](#))

Source Level ([page 105](#))

Input Select ([page 105](#))

## Input Assign

This unit has certain input sources such as "CBL/SAT" assigned to audio and video connectors by default. By making the default connections, you can simply press an input source select button to play back audio or video from the connected device with ease.

When making connections other than the default settings, you must change settings in this section.

### Examples of "Input Assign" menu screen displays

This screen appears when the "Inputs" – "each input source" – "Input Assign" menu is selected. Use the "Input Assign" menu to change the ② HDMI input connectors, ③ Digital input connectors, ④ Analog input connectors, and ⑤ Video input connectors that are assigned to the ① input sources in default settings.

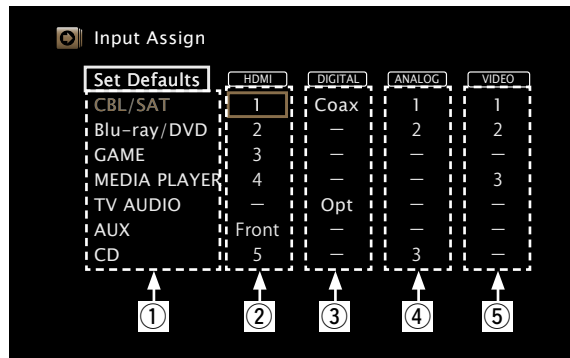

### Input assignments menu operations

- 1 Use  $\Delta \nabla \triangleleft \triangleright$  to move the cursor to the item you want to set, and then press **ENTER**.
- 2 Use  $\triangleleft \triangleright$  to select the input connector to be assigned.
- 3 Press **ENTER** to register the setting.

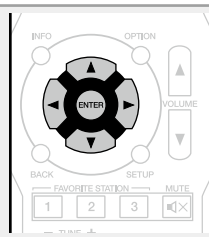

### TV set top box/satellite users please note

#### When using the optical or coaxial digital audio output on a TV/satellite box

To play the video signal assigned to "HDMI" combined with the audio signal assigned at "Input Assign" – "DIGITAL", you will also need to select "Digital" in the "Input Mode" ([page 105](#)).

Setting items	Setting details				
<b>HDMI</b> Set this to change the HDMI input connectors assigned to the input sources.	<b>1 / 2 / 3 / 4 / 5 / Front</b> : Assign an HDMI input connector to the selected input source. – : Do not assign an HDMI input connector to the selected input source.				
<b>CBL/SAT</b> <b>Blu-ray/DVD</b>					
<b>GAME</b> <b>AUX</b>					
<b>MEDIA PLAYER</b> <b>CD</b>					
<b>TV AUDIO</b>					
	<b>Input source</b>	<b>CBL/SAT</b>	<b>Blu-ray/DVD</b>	<b>GAME</b>	<b>MEDIA PLAYER</b>
	<b>Default setting</b>	1	2	3	4
	<b>Input source</b>	<b>TV AUDIO</b>	<b>AUX</b>	<b>CD</b>	
	<b>Default setting</b>	–	Front	5	
	<ul style="list-style-type: none"> <li>• At time of purchase, the settings of the different input sources are as shown below.</li> <li>• To play the video signal assigned at "HDMI" combined with the audio signal assigned at "Input Assign" – "DIGITAL", select "Digital" at "Input Mode" (<a href="#">page 105</a>).</li> <li>• When "HDMI Control" (<a href="#">page 100</a>) is set to "On", HDMI input connector cannot be assigned to "TV AUDIO".</li> </ul>				

Setting items	Setting details																		
<p><b>DIGITAL</b> Set this to change the digital audio input connectors assigned to the input sources.</p> <p> <input type="checkbox"/> CBL/SAT   <input type="checkbox"/> Blu-ray/DVD  <input type="checkbox"/> GAME   <input type="checkbox"/> AUX  <input type="checkbox"/> MEDIA PLAYER   <input type="checkbox"/> CD  <input type="checkbox"/> TV AUDIO                 </p>	<p><b>Coax</b> (Coaxial) / <b>Opt</b> (Optical) : Assign a digital input connector to the selected input source.                      – : Do not assign a digital input connector to the selected input source.</p> <ul style="list-style-type: none"> <li>At time of purchase, the settings of the different input sources are as shown below.</li> </ul> <table border="1"> <tr> <td>Input source</td> <td><input type="checkbox"/> CBL/SAT</td> <td><input type="checkbox"/> Blu-ray/DVD</td> <td><input type="checkbox"/> GAME</td> <td><input type="checkbox"/> MEDIA PLAYER</td> </tr> <tr> <td>Default setting</td> <td>Coax</td> <td>–</td> <td>–</td> <td>–</td> </tr> </table> <table border="1"> <tr> <td>Input source</td> <td><input type="checkbox"/> TV AUDIO</td> <td><input type="checkbox"/> AUX</td> <td><input type="checkbox"/> CD</td> </tr> <tr> <td>Default setting</td> <td>Opt</td> <td>–</td> <td>–</td> </tr> </table>	Input source	<input type="checkbox"/> CBL/SAT	<input type="checkbox"/> Blu-ray/DVD	<input type="checkbox"/> GAME	<input type="checkbox"/> MEDIA PLAYER	Default setting	Coax	–	–	–	Input source	<input type="checkbox"/> TV AUDIO	<input type="checkbox"/> AUX	<input type="checkbox"/> CD	Default setting	Opt	–	–
Input source	<input type="checkbox"/> CBL/SAT	<input type="checkbox"/> Blu-ray/DVD	<input type="checkbox"/> GAME	<input type="checkbox"/> MEDIA PLAYER															
Default setting	Coax	–	–	–															
Input source	<input type="checkbox"/> TV AUDIO	<input type="checkbox"/> AUX	<input type="checkbox"/> CD																
Default setting	Opt	–	–																
<p><b>ANALOG</b> Set this to change the analog audio input connectors assigned to the input sources.</p> <p> <input type="checkbox"/> CBL/SAT   <input type="checkbox"/> Blu-ray/DVD  <input type="checkbox"/> GAME   <input type="checkbox"/> AUX  <input type="checkbox"/> MEDIA PLAYER   <input type="checkbox"/> CD  <input type="checkbox"/> TV AUDIO                 </p>	<p><b>1 / 2 / 3</b> : Assign a analog input connector to the selected input source.                      – : Do not assign a analog input connector to the selected input source.</p> <ul style="list-style-type: none"> <li>At time of purchase, the settings of the different input sources are as shown below.</li> </ul> <table border="1"> <tr> <td>Input source</td> <td><input type="checkbox"/> CBL/SAT</td> <td><input type="checkbox"/> Blu-ray/DVD</td> <td><input type="checkbox"/> GAME</td> <td><input type="checkbox"/> MEDIA PLAYER</td> </tr> <tr> <td>Default setting</td> <td>1</td> <td>2</td> <td>–</td> <td>–</td> </tr> </table> <table border="1"> <tr> <td>Input source</td> <td><input type="checkbox"/> TV AUDIO</td> <td><input type="checkbox"/> AUX</td> <td><input type="checkbox"/> CD</td> </tr> <tr> <td>Default setting</td> <td>–</td> <td>–</td> <td>3</td> </tr> </table>	Input source	<input type="checkbox"/> CBL/SAT	<input type="checkbox"/> Blu-ray/DVD	<input type="checkbox"/> GAME	<input type="checkbox"/> MEDIA PLAYER	Default setting	1	2	–	–	Input source	<input type="checkbox"/> TV AUDIO	<input type="checkbox"/> AUX	<input type="checkbox"/> CD	Default setting	–	–	3
Input source	<input type="checkbox"/> CBL/SAT	<input type="checkbox"/> Blu-ray/DVD	<input type="checkbox"/> GAME	<input type="checkbox"/> MEDIA PLAYER															
Default setting	1	2	–	–															
Input source	<input type="checkbox"/> TV AUDIO	<input type="checkbox"/> AUX	<input type="checkbox"/> CD																
Default setting	–	–	3																

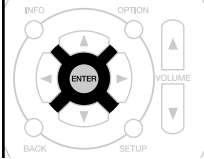
Setting items	Setting details																		
<p><b>VIDEO</b> Set this to change the composite video input connectors assigned to the input sources.</p> <p> <input type="checkbox"/> CBL/SAT   <input type="checkbox"/> Blu-ray/DVD  <input type="checkbox"/> GAME   <input type="checkbox"/> AUX  <input type="checkbox"/> MEDIA PLAYER   <input type="checkbox"/> CD  <input type="checkbox"/> TV AUDIO                 </p>	<p><b>1 / 2 / 3</b> : Assign the video input connector to the selected input source.                      – : Do not assign a video input connector to the selected input source.</p> <ul style="list-style-type: none"> <li>At time of purchase, the settings of the different input sources are as shown below.</li> </ul> <table border="1"> <tr> <td>Input source</td> <td><input type="checkbox"/> CBL/SAT</td> <td><input type="checkbox"/> Blu-ray/DVD</td> <td><input type="checkbox"/> GAME</td> <td><input type="checkbox"/> MEDIA PLAYER</td> </tr> <tr> <td>Default setting</td> <td>1</td> <td>2</td> <td>–</td> <td>3</td> </tr> </table> <table border="1"> <tr> <td>Input source</td> <td><input type="checkbox"/> TV AUDIO</td> <td><input type="checkbox"/> AUX</td> <td><input type="checkbox"/> CD</td> </tr> <tr> <td>Default setting</td> <td>–</td> <td>–</td> <td>–</td> </tr> </table>	Input source	<input type="checkbox"/> CBL/SAT	<input type="checkbox"/> Blu-ray/DVD	<input type="checkbox"/> GAME	<input type="checkbox"/> MEDIA PLAYER	Default setting	1	2	–	3	Input source	<input type="checkbox"/> TV AUDIO	<input type="checkbox"/> AUX	<input type="checkbox"/> CD	Default setting	–	–	–
Input source	<input type="checkbox"/> CBL/SAT	<input type="checkbox"/> Blu-ray/DVD	<input type="checkbox"/> GAME	<input type="checkbox"/> MEDIA PLAYER															
Default setting	1	2	–	3															
Input source	<input type="checkbox"/> TV AUDIO	<input type="checkbox"/> AUX	<input type="checkbox"/> CD																
Default setting	–	–	–																
<p><b>Set Defaults</b> The “Input Assign” settings are returned to the default settings.</p>	<p><b>Reset</b> : Reset to the defaults.  <b>Cancel</b> : Do not reset to the defaults.</p> <p> If you select “Set Defaults” and press <b>ENTER</b>, the message “Reset all input assignments to the factory default?” is displayed. Select “Reset” or “Cancel”, and then press <b>ENTER</b>.</p> 																		

## Source Rename

Change the display name of the selected input source.

This is convenient when the input source name of your device and the input source name of this unit are different. You can change the name to suit your needs. When the renaming is completed, the name is displayed on this unit's display and on the menu screen.

### Setting details

**CBL/SAT / Blu-ray/DVD / GAME / AUX / MEDIA PLAYER / CD / TV AUDIO / M-XPport** : Change the display name of the selected input source.

- Up to 12 characters can be input.
- For character input, see [page 92](#).

**Set Defaults** : The "Source Rename" settings are returned to the default settings.

- **Reset** : Reset to the defaults.
- **Cancel** : Do not reset to the defaults.

 If you select "Set Defaults" and press **ENTER**, the message "Reset all source names to the factory defaults?" is displayed. Select "Reset" or "Cancel", and then press **ENTER**.

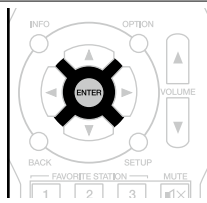

## Hide Sources

**Default settings are underlined.**

Remove from the display input sources that are not used.

### Setting details

**CBL/SAT / Blu-ray/DVD / GAME / AUX / MEDIA PLAYER / iPod/USB / CD / TUNER / Favorites / Internet Radio / Media Server / Pandora / SiriusXM / Spotify / Flickr / TV AUDIO / M-XPport** : Select input source that is not used.

- **Show** : Use this source.
- **Hide** : Do not use this source.

### NOTE

Input sources set to "Hide" cannot be selected using the input source select button.

## Source Level

**Default settings are underlined.**

- This function corrects the playback level of the selected input source's audio input.
- Make this setting if there are differences in the input volume levels between the different sources.

### Setting details



**-12dB – +12dB (0dB)**

## Input Select

**Default settings are underlined.**

Set the audio input mode and decode mode of each input source.

The input modes available for selection may vary depending on the input source.

Setting items	Setting details
<b>Input Mode</b> Set the audio input modes for the different input sources. It is normally recommended to set the audio input mode to "Auto".	<b>Auto</b> : Automatically detect input signal and perform playback. <b>HDMI</b> : Play only signals from HDMI input. <b>Digital</b> : Play only signals from digital input. <b>Analog</b> : Play only signals from analog input.  <ul style="list-style-type: none"> <li>• "Digital" can be set for input sources for which "DIGITAL" is assigned at "Input Assign" (<a href="#">page 104</a>).</li> <li>• When digital signals are properly input, the <b>DIG.</b> indicator lights on the display. If the <b>DIG.</b> indicator does not light, check "Input Assign" (<a href="#">page 104</a>) and the connections.</li> <li>• If "HDMI Control" is set to "On" and a TV compatible with the ARC is connected via the HDMI MONITOR connectors, the input mode whose input source is "TV AUDIO" is fixed to ARC.</li> </ul>
<b>Decode Mode</b> Set the audio decode mode for input source.	<b>Auto</b> : Detect type of digital input signal and decode and play automatically. <b>PCM</b> : Decode and play only PCM input signals. <b>DTS</b> : Decode and play only DTS input signals.  <ul style="list-style-type: none"> <li>• This item can be set for input sources for which "DIGITAL" is assigned at "Input Assign" (<a href="#">page 104</a>).</li> <li>• Normally set this mode to "Auto". Set "PCM" and "DTS" when inputting the corresponding input signal.</li> </ul>

CBL/SAT	Blu-ray/DVD
GAME	AUX
MEDIA PLAYER	CD
TV AUDIO	



Set when changing Audyssey® Setup settings.

- If you change the speaker settings after performing Audyssey® Setup, it will not be possible to set Audyssey MultEQ®, Audyssey Dynamic EQ® and Audyssey Dynamic Volume® (☞ [page 97](#)).
- Can be used without changing the settings. Please set if necessary.

## Menu operation

### 1 Press **SETUP**.

The menu is displayed on the TV screen.

### 2 Use $\Delta$ / $\nabla$ to select the menu to be set or operated.

### 3 Press **ENTER** or $\triangleright$ to enter the setting.

- To return to the previous item, press  $\triangleleft$  or **BACK**.
- Exiting the Menu, press **SETUP** while the menu is displayed. The menu display disappears.

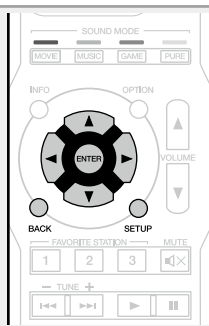

## Items that can be set with the “Speakers” procedure

Audyssey® Setup (☞ [page 23](#))





Manual Setup (☞ [page 107](#))



## Manual Setup



**Default settings are underlined>.**

Perform when setting the speakers manually or when changing settings made in Audyssey® Setup.

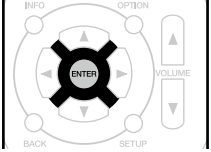
- If you change the speaker settings after performing Audyssey® Setup, it will not be possible to select Audyssey MultEQ®, Audyssey Dynamic EQ® and Audyssey Dynamic Volume® ([page 97](#)).
- “Manual Setup” can be used without changing the settings. Please set if necessary.

Setting items	Setting details
<b>Speaker Config.</b> Indicate speaker presence and select speaker size categories based on bass reproduction capability. <p><b>NOTE</b></p> Do not use the outward shape of the speaker to determine selection of a “Large” or “Small” speaker. Instead, use the frequencies set in “Crossovers” ( <a href="#">page 108</a> ) as the standard for determining bass reproduction capability.	<b>Front</b> : Set the front speaker size. <ul style="list-style-type: none"> <li>• <b>Large</b> : Use a large speaker that can adequately play back very low bass frequencies.</li> <li>• <b>Small</b> : Use a small speaker that has inadequate playback capacity for very low bass frequencies. Note that for most multi-channel speakers, this is the best choice.</li> </ul> <p> When “Subwoofer” is set to “No”, “Front” is automatically set to “Large”.</p> <p> When “Front” is set to “Small”, “Center” and “Surround” can not be set to “Large”.</p> <hr/> <b>Center</b> : Set the presence and size of the center speaker. <ul style="list-style-type: none"> <li>• <b>Large</b> : Use a large speaker that can adequately play back very low bass frequencies.</li> <li>• <b>Small</b> : Use a small speaker that has inadequate playback capacity for very low bass frequencies. Note that this is almost always the best choice.</li> <li>• <b>None</b> : Select when a center speaker is not connected.</li> </ul> <p> “Large” is not displayed when “Front” is set to “Small”.</p> <hr/> <b>Subwoofer</b> : Set the presence of a subwoofer. <ul style="list-style-type: none"> <li>• <b>Yes</b> : Use a subwoofer.</li> <li>• <b>No</b> : Select when a subwoofer is not connected.</li> </ul> <p> When “Front” is set to “Small”, “Subwoofer” is automatically set to “Yes”.</p> <hr/> <b>Surround</b> : Set the presence and size of the surround speakers. <ul style="list-style-type: none"> <li>• <b>Large</b> : Use a large speaker that can adequately play back very low bass frequencies.</li> <li>• <b>Small</b> : Use a small speaker that has inadequate playback capacity for very low bass frequencies. Note that this is almost always the best choice.</li> <li>• <b>None</b> : Select when the surround speakers are not connected.</li> </ul>

Setting items	Setting details
<b>Distances</b> Set distance from listening position to speakers. Measure beforehand the distance from the listening position to each speaker.	<b>Unit</b> : Set the unit of distance. <ul style="list-style-type: none"> <li>• <b>Feet / Meters</b></li> </ul> <b>Step</b> : Set the minimum variable width of the distance. <ul style="list-style-type: none"> <li>• <b>1ft / 0.1ft</b></li> <li>• <b>0.1m / 0.01m</b></li> </ul> <b>Set Defaults</b> : The “Distances” settings are returned to the default settings. <ul style="list-style-type: none"> <li>• <b>Reset</b> : Reset to the defaults.</li> <li>• <b>Cancel</b> : Do not reset to the defaults.</li> </ul> <p> When you select “Set Defaults” and press <b>ENTER</b>, the “Resets all of the distance settings to the factory defaults?” prompt is displayed. Select either “Reset” or “Cancel”, and press <b>ENTER</b>.</p> 
	<b>Front L / Front R / Center / Subwoofer / Surround L / Surround R</b> : Select speaker for distance setting. <ul style="list-style-type: none"> <li>• <b>0.0ft – 60.0ft / 0.00m – 18.00m</b> : Set the distance.</li> </ul> <p> The speakers that can be selected differ depending on the “Speaker Config.” (<a href="#">page 107</a>) settings.</p> <ul style="list-style-type: none"> <li>• Default settings :                Front L / Front R / Center / Subwoofer : 12.0 ft (3.60 m)                Surround L / Surround R : 10.0 ft (3.00 m)</li> <li>• Set the difference in the distance between the speakers to less than 20.0 ft (6.00 m).</li> </ul> <p><b>NOTE</b></p> <p>“Distances” cannot be set for speakers with “Speaker Config.” (<a href="#">page 107</a>) set to “None”.</p>

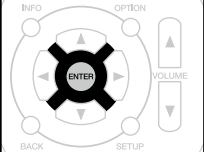
Setting items	Setting details
<b>Levels</b> Set the volume of the test tone to be the same when it is output from each speaker.	<p><b>Test Tone Start</b> : Output test tone.</p> <ul style="list-style-type: none"> <li>• <b>Front L / Center / Front R / Surround R / Surround L / Subwoofer</b> : A test tone is output from the selected speaker. While listening to the test tone, adjust the volume output from the selected speaker.</li> <li>• <b>-12.0dB – +12.0dB (0.0dB)</b> : Adjust the volume.</li> </ul> <p> When “Levels” is adjusted, the adjusted values are set for all the sound modes.</p> <p><b>NOTE</b></p> <ul style="list-style-type: none"> <li>• “Levels” cannot be set for speakers with “Speaker Config.” (<a href="#">page 107</a>) set to “None”.</li> <li>• When headphones are connected to the PHONES connector on this unit, you cannot set “Levels”.</li> </ul> <p><b>Set Defaults</b> : The “Levels” settings are returned to the default settings.</p> <ul style="list-style-type: none"> <li>• <b>Reset</b> : Reset to the defaults.</li> <li>• <b>Cancel</b> : Do not reset to the defaults.</li> </ul> <p> When you select “Set Defaults” and press <b>ENTER</b>, the “Reset all of the channel level settings to the factory defaults?” prompt is displayed. Select either “Reset” or “Cancel”, and press <b>ENTER</b>.</p> 

Setting items	Setting details
<b>Crossovers</b> Set the maximum frequency of the bass signal output from each channel to the subwoofer. Set the Crossover Frequency to suit the bass reproduction capability of the speaker being used.	<p><b>Speaker Select.</b> : Selects how to set the crossover frequency. See the speaker manual for information concerning speaker crossover frequency.</p> <ul style="list-style-type: none"> <li>• <b>All</b> : Selects the crossover point of all speakers at the same time.</li> <li>• <b>Individual</b> : Selects the crossover points for each speaker individually.</li> </ul> <p>The following settings can be set when the “Speaker Select.” setting is set to “Individual”.</p> <ul style="list-style-type: none"> <li>• <b>Front / Center / Surround</b> : Select speaker for setting of crossover frequency.</li> <li>• <b>40Hz / 60Hz / 80Hz / 90Hz / 100Hz / 110Hz / 120Hz / 150Hz / 200Hz / 250Hz</b> : Set the crossover frequency.</li> </ul> <p> “Crossovers” can be set when the “Bass” – “Subwoofer Mode” (<a href="#">page 109</a>) setting is “LFE+Main”, or when you have a speaker that is set to “Small”.</p> <ul style="list-style-type: none"> <li>• The default crossover frequency is “80Hz”, which will work best with the widest variety of speakers. When using very small speakers, however, you can choose a higher setting based on the specified frequency response of the speakers. If the speaker has a specified frequency response of 120 Hz – 20 kHz (as an example), then choose the 120 Hz crossover frequency.</li> <li>• For speakers set to “Small”, low frequency content below the crossover frequency is attenuated to the speakers and the low bass content is then re-delivered to the subwoofer, or the front (L/R) speakers if they have been set to Large.</li> <li>• The speakers that can be set when “Individual” is selected differ depending on to the “Subwoofer Mode” setting (<a href="#">page 109</a>).</li> <li>• When “LFE” is selected, speakers set to “Small” at “Speaker Config.” can be set. If the speakers are set to “Large”, “Full Band” is displayed and the setting cannot be made.</li> <li>• If set to “LFE+Main”, this setting can be made regardless of the speaker size.</li> </ul>

Setting items	Setting details
<p><b>Bass</b> Set subwoofer and LFE signal range playback.</p>	<p><b>Subwoofer Mode</b> : Select low range signals to be reproduced by subwoofer.</p> <ul style="list-style-type: none"> <li>• <b>LFE</b> : The low range signal of the channel set to “Small” speaker size is added to the LFE signal output from the subwoofer.</li> <li>• <b>LFE+Main</b> : The low range signal of all channels is added to the LFE signal output from the subwoofer. This is usually the best setting for most systems.</li> </ul> <p></p> <ul style="list-style-type: none"> <li>• “Subwoofer Mode” can be set when “Speaker Config.” – “Subwoofer” (<a href="#">page 107</a>) is set to other than “No”.</li> <li>• Play music or a movie source and select the mode offering the strongest bass.</li> <li>• Select “LFE+Main” if you want the bass signals to always be produced from the subwoofer.</li> </ul> <p><b>NOTE</b></p> <p>If “Front” and “Center” for “Speaker Config.” are set to “Large”, and “Subwoofer Mode” is set to “LFE”, no sound may be output from the subwoofers, depending on the input signal or selected sound mode.</p> <p><b>LPF for LFE</b> : Set LFE signal playback range. Set this when you want to change the playback frequency (low pass filter point) of the subwoofer.</p> <ul style="list-style-type: none"> <li>• <b>80Hz / 90Hz / 100Hz / 110Hz / 120Hz / 150Hz / 200Hz / 250Hz</b></li> </ul>





To use this unit by connecting it to a home network (LAN), you must configure network settings. If you set up your home network (LAN) via DHCP, set "DHCP" to "On" (use the default setting). This allows this unit to use your home network (LAN).

If you assign an IP address for each device, you must use the "IP Address" setting to assign an IP address to this unit and enter the information about your home network (LAN) such as the gateway address and subnet mask.

## Menu operation

### 1 Press **SETUP**.

The menu is displayed on the TV screen.

### 2 Use $\Delta$ / $\nabla$ to select the menu to be set or operated.

### 3 Press **ENTER** or $\triangleright$ to enter the setting.

- To return to the previous item, press  $\triangleleft$  or **BACK**.
- Exiting the Menu, press **SETUP** while the menu is displayed. The menu display disappears.

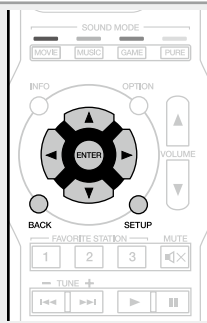

## Items that can be set with the "Network" procedure

Information ([page 111](#))

IP Control ([page 111](#))

Friendly Name ([page 111](#))

Settings ([page 112](#))

Diagnostics ([page 113](#))

Maintenance Mode ([page 113](#))

## Information

Display network information.

### Setting details

#### Friendly Name / DHCP On or Off / IP Address / MAC Address

 MAC Address is required to make a vTuner account.

## IP Control

Default settings are underlined.

Enables network communication in standby power mode.

### Setting details

**Off In Standby** : Suspend network function during standby.

**Always On** : Network is on during standby. Main unit operable with a network compatible controller.

 Set to "Always On" when using the web control function.

### NOTE

When "IP Control" is set to "Always On", it consumes more standby power.

## Friendly Name

The Friendly Name is the name of this unit displayed on the network. You can change the Friendly Name according to your preferences.

### Setting items

#### Edit Name

Edits Friendly Name.

#### Set Defaults

Restores Friendly Name, which you had changed, to the default setting.

### Setting details

- The default Friendly Name on first use is "Marantz NR1504".
- Up to 63 characters can be input.
- For character input, see [page 92](#).

**Reset** : Reset to the defaults.

**Cancel** : Do not reset to the defaults.

 When you select "Set Defaults" and press **ENTER**, the "Reset the friendly name back to the factory default?" prompt is displayed. Select either "Reset" or "Cancel", and press **ENTER**.

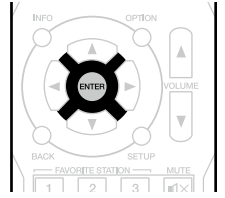

## Settings

Make settings for wired LAN.

Only set "Settings" when connecting to a network without a DHCP function.

### Setting details

### Setting details

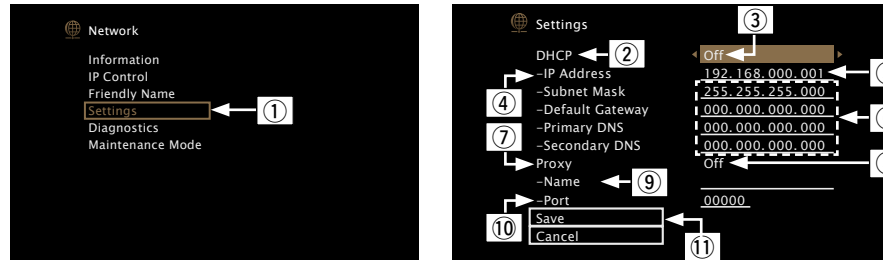

① On the menu, select "Network" – "Settings" and press **ENTER**.

② Use  $\Delta \nabla$  to select "DHCP", then press **ENTER**.

③ Use  $\triangleleft \triangleright$  to select "Off", then press **ENTER**.

④ Use  $\Delta \nabla$  to select "IP Address", then press **ENTER**.

• **IP Address** : Set the IP address within the ranges shown below.

The Network Audio function cannot be used if other IP addresses are set.

CLASS A: 10.0.0.1 – 10.255.255.254

CLASS B: 172.16.0.1 – 172.31.255.254

CLASS C: 192.168.0.1 – 192.168.255.254

⑤ Use  $\Delta \nabla \triangleleft \triangleright$  to input the address and press **ENTER**.

⑥ Use  $\Delta \nabla$  to select setting item, then press **ENTER**.

• **Subnet Mask** : When connecting an xDSL modem or terminal adapter directly to this unit, input the subnet mask indicated in the documentation supplied by your provider. Normally input 255.255.255.0.

• **Default Gateway** : When connected to a gateway (router), input its IP address.

• **Primary DNS, Secondary DNS** : If there is only one DNS address indicated in the documentation supplied by your provider, input it at "Primary DNS". If two or more DNS are provided by your provider, enter both "Primary DNS" and "Secondary DNS".

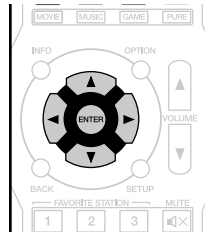

⑦ Use  $\Delta \nabla$  to select "Proxy" and press **ENTER**.

• **Proxy** : Make this setting when connecting to the Internet via a proxy server.

Make the proxy settings only when you connect to the Internet via a proxy server that is on your internal network or provided by your provider, etc.

⑧ Use  $\triangleleft \triangleright$  to select "On(Address)" or "On(Name)", and then press **ENTER**.

**On(Address)** : Select when inputting by address.

**On(Name)** : Select when inputting by domain name. Up to 38 characters can be input.

⑨ Press  $\nabla$  to select "Address" or "Name", then press **ENTER**.

When "Address" is selected in step ⑧ : Use  $\Delta \nabla \triangleleft \triangleright$  to enter the proxy server address, and press **ENTER**.

When "Name" is selected in step ⑧ : Use the software keyboard ([page 92](#)) to enter the domain name, and select **OK**.

• For character input, see [page 92](#).

⑩ Press  $\nabla$  to select "Port", then press **ENTER**. Use  $\Delta \nabla \triangleleft \triangleright$  to input the proxy server port number and press **ENTER**.

Setup is complete.

⑪ Press  $\nabla$  to select "Save", then press **ENTER**.

The display returns to the original screen.



- If you are using a broadband router (DHCP function), there is no need to make the settings at "IP Address" and "Proxy", since the DHCP function is set to "On" in this unit's default settings.
- If this unit is connected to a network without the DHCP function, the network settings must be made. In this case, some knowledge of networks is required. For details, consult a network administrator.
- If you cannot connect to the Internet, recheck the connections and settings ([page 21](#)).
- If you do not understand about Internet connection, contact your ISP (Internet Service Provider) or the store from which you purchased your computer.
- When you want to cancel the setting during IP address input, select "Cancel", then press **ENTER**.

## Diagnostics

Used to check the network connection.

Setting items	Setting details
<b>Physical Connection</b> Checks the physical LAN port connection.	<b>OK</b> : Connected. <b>Error</b> : The LAN cable is not connected. Check the connection.
<b>Router Access</b> Checks the connection from this unit to the router.	<b>OK</b> : Accessed. <b>Error</b> : Failed to communicate with the router. Check the router settings.
<b>Internet Access</b> Checks whether this unit has access to the Internet (WAN).	<b>OK</b> : Connected. <b>Error</b> : Failed to connect to the Internet. Check the Internet connection environment or router settings.

## Maintenance Mode

Use when receiving maintenance from a Marantz service engineer or custom installer. Ordinarily, this mode isn't suitable for use by the end user, only by a trained service technician or custom installation professional.

### Setting details

#### NOTE

Only use this function if so instructed by a Marantz serviceperson or installer.



Make various other settings.

## Menu operation

### 1 Press **SETUP**.

The menu is displayed on the TV screen.

### 2 Use $\Delta$ / $\nabla$ to select the menu to be set or operated.

### 3 Press **ENTER** or $\triangleright$ to enter the setting.

- To return to the previous item, press  $\triangleleft$  or **BACK**.
- Exiting the Menu, press **SETUP** while the menu is displayed. The menu display disappears.

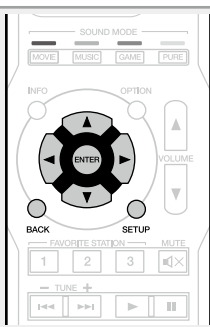

## Items that can be set with the "General" procedure

**Language** ( [page 115](#))

**Auto Standby** ( [page 115](#))

**Front Display** ( [page 115](#))

**Information** ( [page 116](#))

**Usage Data** ( [page 117](#))

**Firmware** ( [page 117](#))

**Setup Lock** ( [page 118](#))

## Language

Default settings are underlined.

Set the language for display on the menu screen.

### Setting details

**English / Français / Español**



"Language" can also be set by the following procedure. However, the menu screen is not displayed. Following the display content to make the setting.

1. Press and hold the main unit's **PRESET CH –** and **STATUS** for at least 3 seconds.  
"V.Format:<NTSC>" appears on the display.
2. Press the main unit's **DISPLAY** and set "Lang.:<ENGLISH >".
3. Use the main unit's **PRESET CH –** or **PRESET CH +** and set the language.
4. Press the main unit's **STATUS** to complete the setting.

## Auto Standby

Default settings are underlined.

When you do not perform any operation on this unit with no audio or video input for a specified time, this unit automatically enters the standby mode. Before it enters the standby mode, "Auto Standby" is displayed on the display of this unit and the menu screen.

### Setting details

- 60 min** : The unit goes into standby after 60 minutes.  
**30 min** : The unit goes into standby after 30 minutes.  
**Off** : The unit does not go into standby automatically.

## Front Display

Default settings are underlined.

Makes settings related to the display on this unit.

### Setting items

**Display**

### Setting details

**On** : Display is always on.

**Auto Off** : Display is off except when showing the status display.

**Off** : Display is always off.



Buttons on the main unit can be used for operations.

Each time **DISPLAY** is pressed, the setting is changed as shown below.

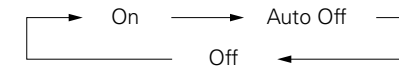

### NOTE

When "Display" is set to "Off", the display turns off and appears as if there is no electricity.

## Information

Show information about receiver settings, input signals, etc.

Items	Setting details				
<b>Audio</b> Show information about audio input signals.	<p><b>Sound Mode</b> : The currently set surround mode.  <b>Input Signal</b> : The input signal type.  <b>Format</b> : The number of input signal channels (presence of front, surround, LFE).  <b>Sample Rate</b> : The input signal's sampling frequency.  <b>Offset</b> : The dialogue normalization correction value.  <b>Flag</b> : This is displayed when inputting signals including a surround back channel. "MATRIX" is displayed with Dolby Digital EX and DTS-ES Matrix signals, "DISCRETE" with DTS-ES Discrete signals.</p> <table border="1" style="width: 100%; text-align: center;"> <thead> <tr> <th>Dialogue normalization function</th> </tr> </thead> <tbody> <tr> <td>                     This function is automatically activated when playing Dolby Digital, Dolby Digital Plus, Dolby TrueHD, DTS and DTS-HD sources. It automatically corrects the standard signal level for individual program sources. The correction value can be checked using the <b>STATUS</b> on the main unit.                 </td> </tr> <tr> <td style="text-align: center;"> <div style="border: 1px solid black; padding: 5px; display: inline-block;">Offset: - 4dB</div> </td> </tr> <tr> <td>                     The figure is the corrected value. This cannot be changed.                 </td> </tr> </tbody> </table>	Dialogue normalization function	This function is automatically activated when playing Dolby Digital, Dolby Digital Plus, Dolby TrueHD, DTS and DTS-HD sources. It automatically corrects the standard signal level for individual program sources. The correction value can be checked using the <b>STATUS</b> on the main unit.	<div style="border: 1px solid black; padding: 5px; display: inline-block;">Offset: - 4dB</div>	The figure is the corrected value. This cannot be changed.
Dialogue normalization function					
This function is automatically activated when playing Dolby Digital, Dolby Digital Plus, Dolby TrueHD, DTS and DTS-HD sources. It automatically corrects the standard signal level for individual program sources. The correction value can be checked using the <b>STATUS</b> on the main unit.					
<div style="border: 1px solid black; padding: 5px; display: inline-block;">Offset: - 4dB</div>					
The figure is the corrected value. This cannot be changed.					
<b>Video</b> Show information about HDMI input/output signals and HDMI monitors.	<p><b>HDMI Signal</b></p> <ul style="list-style-type: none"> <li>• Resolution / Color Space / Pixel Depth</li> </ul> <p><b>HDMI Monitor</b></p> <ul style="list-style-type: none"> <li>• Interface / Resolutions</li> </ul>				
<b>Status</b> Show information about current settings.	<p><b>MAIN ZONE</b> : This item shows information about settings for MAIN ZONE. The information displayed differs according to the input source.</p> <ul style="list-style-type: none"> <li>• Select Source / Name / Sound Mode / Input Mode / Decode Mode / HDMI / Digital / Analog / Video / Video Select etc.</li> </ul>				
<b>Firmware</b>	<p><b>Version</b> : Displays information for the current firmware.</p>				
<b>Notifications</b> Selects notification message preferences.	<p><b>Notification Alerts</b></p> <ul style="list-style-type: none"> <li>• <b>On</b> : Displays notification messages from Marantz in the popup menu.</li> <li>• <b>Off</b> : Does not display notification messages from Marantz in the popup menu.</li> </ul>				



Press **INFO** to display current source name, volume, sound mode name, and other information at the bottom of the screen.

### Examples of screen display

- Status display screen
- When the input source is switched.



When the volume is adjusted.

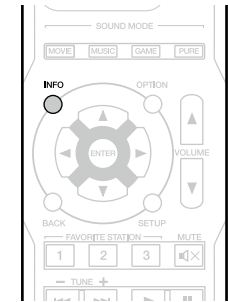
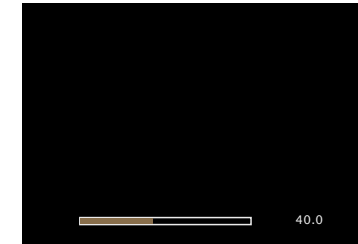

Status display: The operating status appears briefly on the screen when the input source is switched or the volume is changed.

### NOTE

The status display screen cannot be displayed at a computer's resolution (e.g. VGA) or while certain 3D video contents is being played.

## Usage Data

To help us improve our products and customer service, Marantz collects anonymous information about how you use your AV receiver (such as frequently used input sources and sound modes and speaker settings). Marantz will never provide any information we collect to third parties.

### Setting details



**Yes** : Provide Marantz with information about how you use this unit via the network.

**No** : Do not provide Marantz with information about how you use this unit via the network.

## Firmware

Set whether or not to check for firmware update, update the firmware, and display update and upgrade notifications.

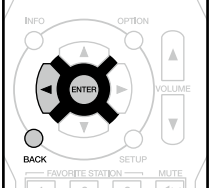
Setting items	Setting details												
<p><b>Update</b> Update the firmware of the receiver.</p> <p><b>NOTE</b> In cases where it is not possible to connect to the network after doing a firmware update, connect to the network again using "Network" (<a href="#">page 110</a>).</p>	<p><b>Check for Update</b> : Check for firmware updates. You can also check approximately how long it will take to complete an update.</p> <p><b>Update Start</b> : Execute the update process.</p> <p>When updating starts, the power indicator becomes red and the menu screen is shut down. The amount of update time which has elapsed is displayed.</p> <ul style="list-style-type: none"> <li>If updating fails, the set automatically retries, but if updating is still not possible, one of the messages shown below is displayed. If the display reads as shown below, check the settings and network environment, then update again.</li> </ul> <table border="1"> <thead> <tr> <th>Display</th> <th>Description</th> </tr> </thead> <tbody> <tr> <td><b>Updating fail</b></td> <td>Updating failed.</td> </tr> <tr> <td><b>Login failed</b></td> <td>Failure to log into server.</td> </tr> <tr> <td><b>Server is busy</b></td> <td>Server is busy. Wait a while then try again.</td> </tr> <tr> <td><b>Connection fail</b></td> <td>Failure in connecting to server.</td> </tr> <tr> <td><b>Download fail</b></td> <td>Downloading of the firmware has failed.</td> </tr> </tbody> </table>	Display	Description	<b>Updating fail</b>	Updating failed.	<b>Login failed</b>	Failure to log into server.	<b>Server is busy</b>	Server is busy. Wait a while then try again.	<b>Connection fail</b>	Failure in connecting to server.	<b>Download fail</b>	Downloading of the firmware has failed.
Display	Description												
<b>Updating fail</b>	Updating failed.												
<b>Login failed</b>	Failure to log into server.												
<b>Server is busy</b>	Server is busy. Wait a while then try again.												
<b>Connection fail</b>	Failure in connecting to server.												
<b>Download fail</b>	Downloading of the firmware has failed.												

Setting items	Setting details
<p><b>Notifications</b> Displays a notification message on this unit's menu screen when the latest firmware is released with "Update". Display a notification message on this unit's menu screen when downloadable firmware is released with "Add New Feature".</p>	<p><b>Update</b> : The notification message is displayed for about 20 seconds when the power is turned on. Connect to broadband Internet (<a href="#">page 21</a>) when using this function.</p> <ul style="list-style-type: none"> <li><b>On</b> : Display update message.</li> <li><b>Off</b> : Do not display update message.</li> </ul> <p> When you press <b>ENTER</b> during display of the notification message, the "Check for Update" screen is displayed (Refer to <a href="#">page 117</a> for more information on "Update").</p> <ul style="list-style-type: none"> <li>Press <b>◀</b> or <b>BACK</b> to erase the notification message.</li> </ul> <p></p> <p><b>Upgrade</b> : The notification message is displayed for about 20 seconds when the power is turned on. Connect to broadband Internet (<a href="#">page 21</a>) when using this function.</p> <ul style="list-style-type: none"> <li><b>On</b> : Display upgrade message.</li> <li><b>Off</b> : Do not display upgrade message.</li> </ul> <p> When you press <b>ENTER</b> during display of the notification message, the "Add New Feature" screen is displayed (Refer to <a href="#">page 118</a> for more information on "Add New Feature").</p> <ul style="list-style-type: none"> <li>Press <b>◀</b> or <b>BACK</b> to erase the notification message.</li> </ul>



Setting items	Setting details
<p><b>Add New Feature</b> Display new features that can be downloaded to this unit and perform an upgrade.</p> <p><b>NOTE</b> In cases where it is not possible to connect to the network after adding a new function, connect to the network again using "Network" (<a href="#">page 110</a>).</p>	<p><b>Upgrade Package</b> : Display the items to be upgraded. <b>Upgrade Status</b> : Display a list of the additional functions provided by the upgrade. <b>Upgrade Start</b> : Execute the upgrade process. When the upgrade starts, the power indicator becomes red and the menu screen is shut down. During the upgrade, the amount of upgrade time which has elapsed is displayed.</p> <ul style="list-style-type: none"> <li>If the upgrade is not successful, an error message identical to those in "Update" will appear on the display. Check the settings and network environment and then perform the upgrade again.</li> </ul> <p> See the Marantz website for details about upgrades. When the procedure is complete, "Registered" is displayed in this menu and upgrades can be carried out. If the procedure has not been carried out, "Not Registered" is displayed. The ID number shown on this screen is needed when carrying out the procedure. The ID number can also be displayed by pressing and holding the main unit's <b>STATUS</b> and <b>SOUND MODE</b> for at least 3 seconds.</p>

#### Notes concerning use of "Update" and "Add New Feature"

- In order to use these functions, you must have the correct system requirements and settings for a broadband Internet connection ([page 21](#)).
- Do not turn off the power until updating or upgrading is completed.
- Even with a broadband connection to the Internet, approximately 1 hour is required for the updating/upgrading procedure to be completed.
- Once updating/upgrade starts, normal operations on this unit cannot be performed until updating/upgrading is completed. Furthermore, there may be cases where backup data is reset for the parameters, etc., set on this unit.
- If the update or upgrade fails, press and hold the  on the main unit for more than 5 seconds, or remove and re-insert the power cord. "Update retry" appears on the display and update restarts from the point at which update failed. If the error continues despite this, check the network environment.



- Information regarding the "Update" function and "Add New Feature" will be announced on the Marantz web site each time related plans are defined.
- When usable new firmware is released with "Update" or "Add New Feature", a notification message is displayed on the menu screen. When you do not want to be notified, set "Notifications" – "Update" ([page 117](#)) and "Notifications" – "Upgrade" ([page 117](#)) to "Off".

## Setup Lock

**Default settings are underlined.**





Protect settings from inadvertent changes.

Setting items	Setting details
<b>Lock</b>	<p><b>On</b> : Turn protection on. <b>Off</b> : Turn protection off.</p> <p> When cancelling the setting, set "Lock" to "Off".</p> <p><b>NOTE</b> When "Lock" is set to "On", the settings listed below can no longer be changed. Also, "Setup Locked!" is displayed if you attempt to operate related settings.</p> <ul style="list-style-type: none"> <li>Setup menu operations</li> </ul>

## Information

---

Here we list other information related to this unit.  
Please refer to this information as needed.

- Part names and functions  [page 120](#)
- Other information  [page 125](#)
- Troubleshooting  [page 132](#)
- Specifications  [page 136](#)
- Index  [page 137](#)

# Part names and functions

## Front panel

For buttons not explained here, see the page indicated in parentheses ( ).

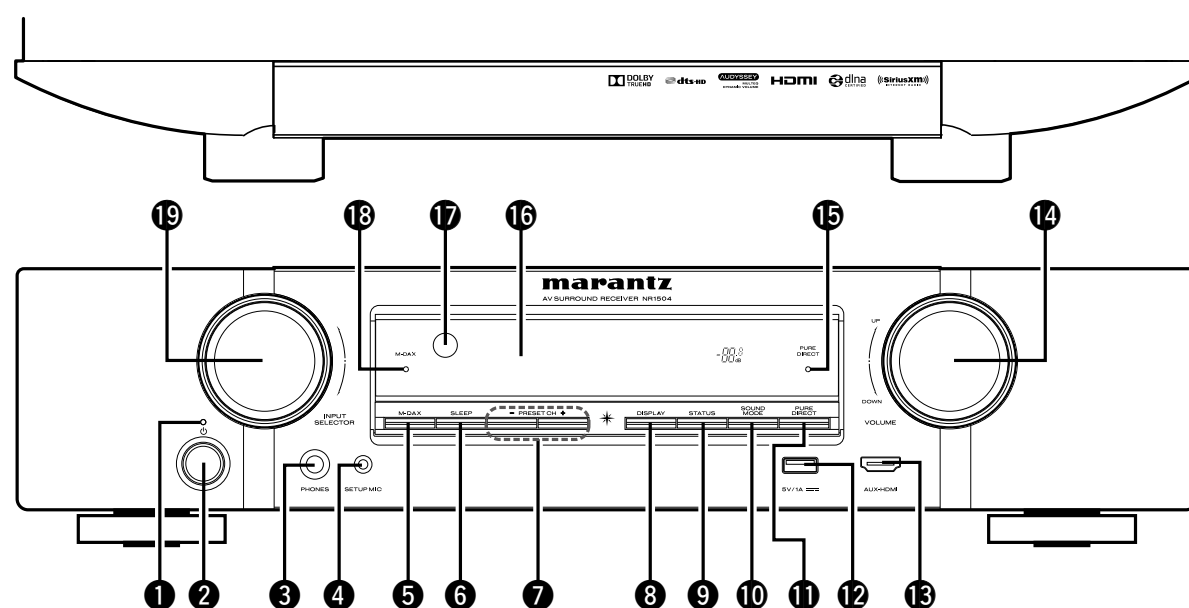

- |   |   |  |
|---|---|--|
| <p><b>1 Power indicator</b> ..... (30)<br/> <b>[Power indicator status]</b><br/>         • Power on : Off<br/>         • Normal standby : Red<br/>         • When "HDMI Pass Through" or "HDMI Control" (page 100) is set to "On" : Orange<br/>         • When "IP Control" (page 111) is set to "Always On" : Orange</p> <p><b>2 Power operation button (b)</b> ..... (30)<br/>         Turns power to this unit on and off (standby).</p> | <p><b>3 Headphones jack (PHONES)</b><br/>         When the headphones are plugged into this jack, audio will no longer be output from the connected speakers.</p> <p><b>NOTE</b><br/>         To prevent hearing loss, do not raise the volume level excessively when using headphones.</p> <p><b>4 SETUP MIC jack</b> ..... (24)</p> <p><b>5 M-DAX button</b> ..... (96)</p> <p><b>6 SLEEP button</b> ..... (84)</p> <p><b>7 Tuner preset channel buttons (PRESET CH +, -)</b> ..... (38, 42)</p> <p><b>8 DISPLAY button</b> ..... (115)</p> | <p><b>9 STATUS button</b> ..... (33, 48, 52, 64, 116)</p> <p><b>10 SOUND MODE button</b> ..... (72)</p> <p><b>11 PURE DIRECT button</b> ..... (73)</p> <p><b>12 USB port</b> ..... (17, 36)</p> <p><b>13 AUX-HDMI connector</b> ..... (10)</p> <p><b>14 VOLUME knob</b> ..... (31)</p> <p><b>15 PURE DIRECT indicator</b> ..... (73)</p> <p><b>16 Display</b> ..... (121)</p> <p><b>17 Remote control sensor</b> ..... (124)</p> <p><b>18 M-DAX indicator</b> ..... (96)</p> <p><b>19 INPUT SELECTOR knob</b> ..... (30)</p> |
|---|---|--|

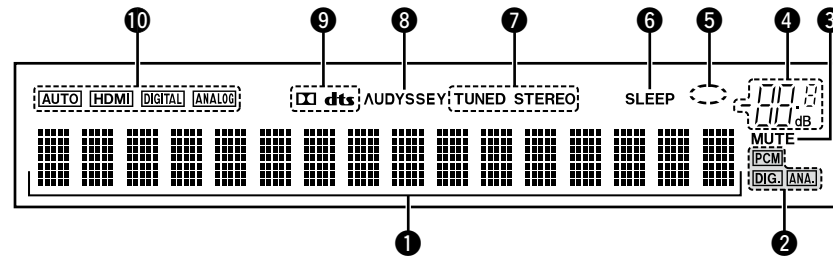

## 1 Information display

The input source name, sound mode, setting values and other information are displayed here.

## 2 Input signal indicators

### 3 MUTE indicator

This lights when the audio mute mode is selected ([page 31](#)).

### 4 Master volume indicator

### 5 Circle indicator

Circle indicator is displayed when the input source is "NETWORK" or "iPod/USB" when you are playing back music.

## 6 Sleep timer indicator

This lights when the sleep mode is selected ([page 84](#)).

## 7 Tuner reception mode indicators

These light according to the reception conditions when the input source is set to "TUNER".

**STEREO** : In FM mode, this lights up when receiving stereo broadcasts.

**TUNED** : Lights up when the broadcast is properly tuned in.

## 8 Audyssey® indicator

This indicator lights when the "MultEQ®" ([page 97](#)), "Dynamic EQ" ([page 97](#)) or "Dynamic Volume" ([page 97](#)) setting is set to other than "Off".

## 9 Decoder indicator

These light when Dolby or DTS signals are input or when the Dolby or DTS decoder is running.

## 10 Input mode indicators

Set the audio input modes for the different input sources ([page 105](#)).

# Rear panel

See the page indicated in parentheses ( ).

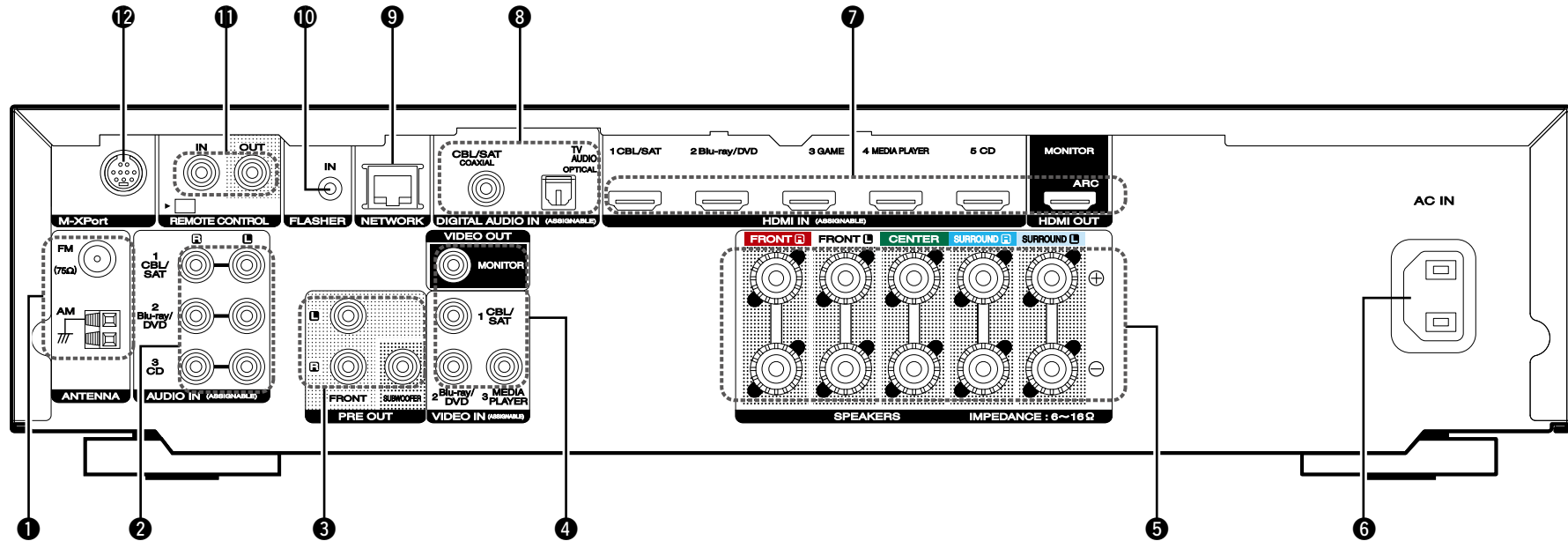

- ① FM/AM antenna terminals (ANTENNA) ..... (19)
- ② Analog audio connectors (AUDIO) ..... (14, 15, 18)
- ③ PRE OUT connectors ..... (81)
- ④ Video connectors (VIDEO) ..... (13, 14, 15, 16)
- ⑤ Speaker terminals (SPEAKERS) ..... (81)
- ⑥ AC inlet (AC IN) ..... (22)
- ⑦ HDMI connectors ..... (9, 10)
- ⑧ Digital audio connectors (DIGITAL AUDIO) ..... (13, 14)
- ⑨ Network connector (NETWORK) ..... (21)
- ⑩ FLASHER IN jack  
Used when using a control BOX or other such control devices to control this unit.
- ⑪ REMOTE CONTROL connectors ..... (82)
- ⑫ M-XPort connector ..... (20)

**NOTE**

Do not touch the inner pins of the connectors on the rear panel. Electrostatic discharge may cause permanent damage to the unit.

# Remote control unit

For buttons not explained here, see the page indicated in parentheses ( ).

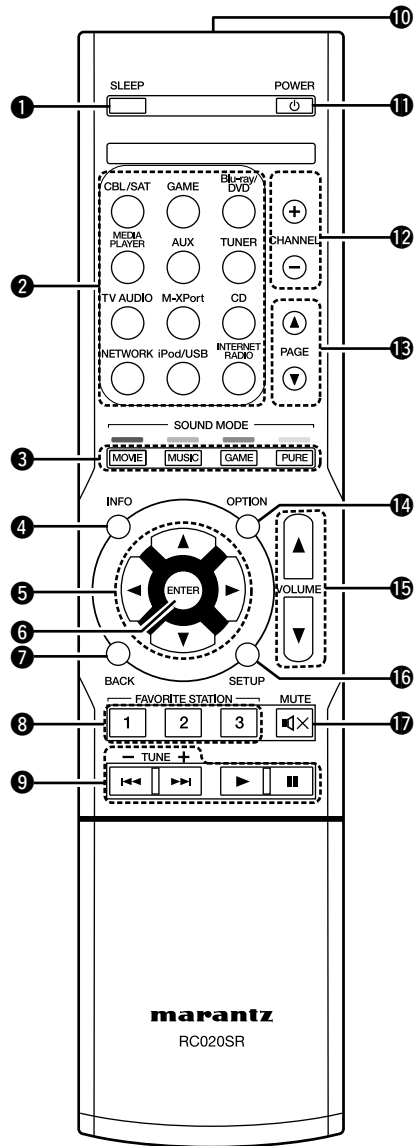

- 1 SLEEP button ..... (84)
- 2 Input source select buttons ..... (30)
- 3 SOUND MODE buttons ..... (72)
  - MOVIE button
  - MUSIC button
  - GAME button
  - PURE button
- 4 Information button (INFO) ..... (116)
- 5 Cursor buttons (▲▼◀▶) ..... (91, 93, 99, 102, 106, 110, 114)
- 6 ENTER button ..... (91, 93, 99, 102, 106, 110, 114)
- 7 BACK button ..... (36, 48, 52, 55, 61, 64)
- 8 FAVORITE STATION buttons (1 – 3) ..... (67)
- 9 System buttons ..... (34, 37, 53, 60)
  - Skip buttons (◀◀, ▶▶)
  - Play button (▶)
  - Pause button (||)
- Tuning up / Tuning down buttons (TUNE +, -) ..... (38, 42)
- 10 Remote control signal transmitter ..... (124)
- 11 POWER button (⏻) ..... (30)
- 12 Channel buttons (+, -) ..... (34, 37, 41, 46, 49, 53, 56, 60, 62, 64)
- 13 Page search buttons (PAGE ▲▼) ..... (34, 37, 41, 46, 49, 53, 56, 60, 62, 64)
- 14 OPTION button ..... (32, 36, 39, 48, 53, 55, 64)
- 15 VOLUME buttons (▲▼) ..... (31)
- 16 SETUP button ..... (91, 93, 99, 102, 106, 110, 114)
- 17 MUTE button (⏻) ..... (31)

## Inserting the batteries

- ① Remove the rear lid in the direction of the arrow and remove it.
- ② Load the two batteries properly as indicated by the marks in the battery compartment.

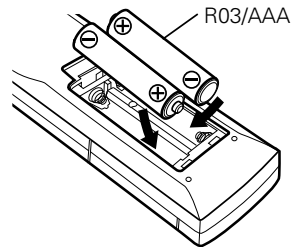
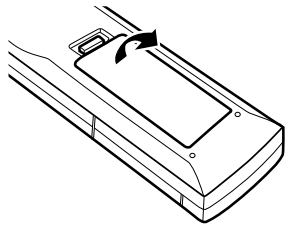

- ③ Put the rear cover back on.

### NOTE

- Insert the specified batteries in the remote control unit.
- Replace the batteries with new ones if the set does not operate even when the remote control unit is operated close to the unit. (The supplied batteries are only for verifying operation. Replace them with new batteries at an early date.)
- When inserting the batteries, be sure to do so in the proper direction, following the  $\oplus$  and  $\ominus$  marks in the battery compartment.
- To prevent damage or leakage of battery fluid:
  - Do not use a new battery together with an old one.
  - Do not use two different types of batteries.
  - Do not attempt to charge dry batteries.
  - Do not short-circuit, disassemble, heat or dispose of batteries in flames.
  - Do not keep the battery in a place exposed to direct sunlight or in places with extremely high temperatures, such as near a heater.
- If the battery fluid should leak, carefully wipe the fluid off the inside of the battery compartment and insert new batteries.
- Remove the batteries from the remote control unit if it will not be in use for long periods.
- Used batteries should be disposed of in accordance with the local regulations regarding battery disposal.
- The remote control unit may function improperly if rechargeable batteries are used.

## Operating range of the remote control unit

Point the remote control unit at the remote sensor when operating it.

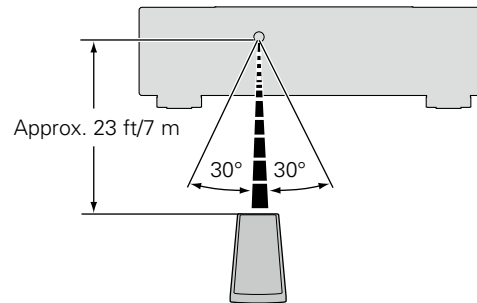

### NOTE

- The set may function improperly or the remote control unit may not operate if the remote control sensor is exposed to direct sunlight, strong artificial light from an inverter type fluorescent lamp or infrared light.
- When using 3D video devices that transmit infrared communication signals (such as infrared signals etc) between the various units (such as the monitor, 3D glasses, 3D transmitter unit etc), the remote control unit may not operate due to interference from those communication signals. If this occurs, adjust the direction and distance of the 3D communication for each unit, and check that the remote control unit operation is not affected by these signals.

# Other information

- ❑ **Trademark information** ([page 125](#))
- ❑ **Surround** ([page 126](#))
- ❑ **Relationship between video signals and monitor output** ([page 129](#))
- ❑ **Explanation of terms** ([page 130](#))

## Trademark information



Manufactured under license from Audyssey Laboratories™. U.S. and foreign patents pending. Audyssey MultEQ®, Audyssey Dynamic EQ® and Audyssey Dynamic Volume® are registered trademarks of Audyssey Laboratories.



Manufactured under license from Dolby Laboratories. “Dolby”, “Pro Logic” and the double-D symbol are trademarks of Dolby Laboratories.



Manufactured under license under U.S. Patent Nos: 5,956,674; 5,974,380; 6,226,616; 6,487,535; 7,212,872; 7,333,929; 7,392,195; 7,272,567 & other U.S. and worldwide patents issued & pending. DTS-HD, the Symbol, & DTS-HD and the Symbol together are registered trademarks of DTS, Inc. Product includes software. © DTS, Inc. All Rights Reserved.



The terms HDMI and HDMI High-Definition Multimedia Interface, and the HDMI Logo are trademarks or registered trademarks of HDMI Licensing LLC in the United States and other countries.



“Made for iPod” and “Made for iPhone” mean that an electronic accessory has been designed to connect specifically to iPod, or iPhone, respectively, and has been certified by the developer to meet Apple performance standards.

Apple is not responsible for the operation of this device or its compliance with safety and regulatory standards. Please note that the use of this accessory with iPod, or iPhone, may affect wireless performance.

AirPlay, the AirPlay logo, iPad, iPhone, iPod, iPod classic, iPod nano, iPod shuffle and iPod touch are trademarks of Apple Inc., registered in the U.S. and other countries.

- Individual users are permitted to use iPhone, iPod, iPod classic, iPod nano, iPod shuffle, and iPod touch for private copy and playback of non-copyrighted contents and contents whose copy and playback is permitted by law. Copyright infringement is prohibited by law.



Windows Media and the Windows logo are trademarks or registered trademarks of Microsoft Corporation in the United States and/or other countries.



Adobe, the Adobe logo and Reader are either registered trademarks or trademarks of Adobe Systems Incorporated in the United States and/or other countries.



# Surround

This unit is equipped with a sophisticated digital signal processing circuit that lets you play your favorite movie and music sources and listen to them with a wide range of surround sound mode choices.

## Sound modes and surround parameters

This table shows the speakers that can be used in each sound mode and the surround parameters adjustable in each sound mode.

### Symbols in the table

- This indicates the audio output channels or surround parameters that can be set.
- ◎ This indicates the audio output channels. The output channels depend on the settings of "Speaker Config." ([page 107](#)).

Sound Mode ( <a href="#">page 72</a> )	Channel output				Surr.Parameter ( <a href="#">page 94</a> )			
	Front L/R	Center	Surround L/R	Subwoofer	Home Theater EQ ( <a href="#">page 94</a> )	Loudness Mngmt *2 ( <a href="#">page 94</a> )	Dynamic Comp. *3 ( <a href="#">page 94</a> )	Low Frequency *4 ( <a href="#">page 94</a> )
DIRECT/PURE DIRECT (2-channel)*1	○			◎*5		○	○	
DIRECT/PURE DIRECT (Multi-channel)*1	○	◎	◎	◎		○	○	○
STEREO	○			◎		○	○	○
MULTI CH IN	○	◎	◎	◎	○			○
DOLBY PRO LOGIC II	○	◎	◎	◎	○	○	○	
DOLBY DIGITAL	○	◎	◎	◎	○		○	○
DOLBY DIGITAL Plus	○	◎	◎	◎	○		○	○
DOLBY TrueHD	○	◎	◎	◎	○	○	○	○
DTS NEO:6	○	◎	◎	◎	○	○	○	
DTS SURROUND	○	◎	◎	◎	○		○	○
DTS 96/24	○	◎	◎	◎	○		○	○
DTS-HD	○	◎	◎	◎	○		○	○
DTS Express	○	◎	◎	◎	○		○	○
MULTI CH STEREO	○	◎	◎	◎		○	○	○
VIRTUAL	○			◎		○	○	○

- \*1 During playback in PURE DIRECT mode, the surround parameters are the same as in DIRECT mode.
- \*2 This item can be selected when a Dolby TrueHD signal is played.
- \*3 This item can be selected when a Dolby Digital or DTS signal is played.
- \*4 This item can be selected when a Dolby Digital or DTS signal or DVD-Audio is played.
- \*5 Only when "Subwoofer Mode" is set to "LFE+Main" ([page 109](#)), sound is output from the subwoofer.

Sound Mode (page 72)	Surr.Parameter (page 94)				Tone *6 (page 95)	Audyssey (page 97)			M-DAX *9 (page 96)
	PRO LOGIC II Music mode only			NEO:6 Music mode only		MultEQ® *7 (page 97)	Dynamic EQ *8 (page 97)	Dynamic Volume *8 (page 97)	
	Panorama (page 95)	Dimension (page 95)	Center Width (page 95)	Center Image (page 95)					
DIRECT/PURE DIRECT (2-channel)* 1									
DIRECT/PURE DIRECT (Multi-channel)* 1									
STEREO					○	○	○	○	○
MULTI CH IN					○	○	○	○	○
DOLBY PRO LOGIC II	○	○	○		○	○	○	○	○
DOLBY DIGITAL					○	○	○	○	
DOLBY DIGITAL Plus					○	○	○	○	
DOLBY TrueHD					○	○	○	○	
DTS NEO:6				○	○	○	○	○	○
DTS SURROUND					○	○	○	○	
DTS 96/24					○	○	○	○	
DTS-HD					○	○	○	○	
DTS Express					○	○	○	○	
MULTI CH STEREO					○	○	○	○	○
VIRTUAL					○	○	○	○	○

\*1 During playback in PURE DIRECT mode, the surround parameters are the same as in DIRECT mode.

\*6 This item cannot be set when "Dynamic EQ" (page 97) is set to "On".

\*7 For HD Audio whose sampling frequency of an input signal is more than 96 kHz, this sound parameter cannot be set.

\*8 This item cannot be set when "MultEQ" (page 97) is set to "Off" or "Manual EQ".

\*9 This item can be set when the input signal is analog, PCM 48 kHz or 44.1 kHz.

### Types of input signals, and corresponding sound modes

This table shows the input signal that can be played in each sound mode. Check the audio signal of the input source then select the sound mode.

#### Symbols in the table

- This indicates the default sound mode.
- This indicates the selectable sound mode.

Sound Mode (see page 72)	Input signal types and formats															
	ANALOG	PCM		DTS-HD		DTS					DOLBY		DOLBY DIGITAL			
		PCM (Multi-channel)	PCM (2-channel)	DTS-HD Master Audio	DTS-HD High Resolution Audio	DTS EXPRESS	DTS ES DSCRT (With Flag)	DTS ES MTRX (With Flag)	DTS (5.1-channel)	DTS 96/24	DOLBY TrueHD	DOLBY DIGITAL Plus	DOLBY DIGITAL EX (With Flag)	DOLBY DIGITAL EX (With no Flag)	DOLBY DIGITAL (5.1-channel)	DOLBY DIGITAL (2-channel)
DTS SURROUND																
DTS-HD MSTR				●												
DTS-HD HI RES					●											
DTS SURROUND							○	○	●							
DTS 96/24										●						
DTS EXPRESS						●										
DTS NEO:6 CINEMA	○														○	
DTS NEO:6 MUSIC	○														○	
DOLBY SURROUND																
DOLBY TrueHD											●					
DOLBY DIGITAL+												●				
DOLBY DIGITAL													○	●	●	
DOLBY PRO LOGIC II MOVIE	○														○	
DOLBY PRO LOGIC II MUSIC	○														○	
DOLBY PRO LOGIC II GAME	○														○	
MULTI CH IN																
MULTI CH IN		●														
DIRECT																
DIRECT	○	○	○	○	○	○	○	○	○	○	○	○	○	○	○	
PURE DIRECT																
PURE DIRECT	○	○	○	○	○	○	○	○	○	○	○	○	○	○	○	
DSP SIMULATION																
MULTI CH STEREO	○	○	○	○	○	○	○	○	○	○	○	○	○	○	○	
VIRTUAL	○	○	○	○	○	○	○	○	○	○	○	○	○	○	○	
STEREO																
STEREO	●	○	●	○	○	○	○	○	○	○	○	○	○	○	○	

## Relationship between video signals and monitor output

Input		Output		Video output	
		HDMI	VIDEO	HDMI output	
HDMI	VIDEO	Video	Menu	Video	Menu
×	×	×	Only the menu is displayed	×	×
×	○			○ <VIDEO>	
○	×	○ <HDMI>	○ (HDMI)	×	
○	○			○ <VIDEO>	

○ Video signal input present  
 × No video signal input

○ <> The input signal between the < > marks is output.  
 × No video signal output  
 ○ ( ) Superimposed on the picture indicated in ( ).  
 × ( ) Only the picture in ( ) is output.

### NOTE

- If you operate the menu while playing back 3D video content or computer's resolution (e.g. VGA), the playback video is replaced by the menu screen. The playback video is not displayed behind the menu screen.
- This unit does not show the status display while playing back 3D video content or computer's resolution (e.g. VGA).
- The network menu is only output to TVs that support HDMI.

## Explanation of terms

### A

#### **A2DP**

A2DP is one profile of Bluetooth defined for in-car devices or AV devices that use wireless communication instead of a cable.

#### **Adobe RGB color, Adobe YCC601 color**

The color space defined by Adobe Systems Inc. Because it is a wider color space than RGB, it can produce more vivid and natural images.

#### **AirPlay**

AirPlay sends (plays) contents recorded in iTunes or on an iPhone/iPod touch/iPad to a compatible device via the network.

#### **ALAC (Apple Lossless Audio Codec)**

This is a codec for lossless audio compression method developed by Apple Inc. This codec can be played back on iTunes, iPod or iPhone. Data compressed to approximately 60 – 70 % can be decompressed to exactly the same original data.

#### **App Store**

App Store is a site that sells application software for such devices as the iPhone or iPod Touch, and is operated by Apple Inc.

#### **Audyssey Dynamic EQ®**

Dynamic EQ solves the problem of deteriorating sound quality as volume is decreased by taking into account human perception and room acoustics. Audyssey Dynamic EQ® works in tandem with Audyssey MultEQ® to provide well-balanced sound for every listener at any volume level.

#### **Audyssey Dynamic Volume®**

Dynamic Volume solves the problem of large variations in volume level between television programs, commercials, and between the soft and loud passages of movies. Audyssey Dynamic EQ® is integrated into Dynamic Volume so that as the playback volume is adjusted automatically, the perceived bass response, tonal balance, surround impression, and dialog clarity remain the same.

#### **Audyssey MultEQ®**

MultEQ® is a room equalization solution that calibrates any audio system so that it can achieve optimum performance for every listener in a large listening area. Based on several room measurements, MultEQ® calculates an equalization solution that corrects for both time and frequency response problems in the listening area and also performs a fully automated surround system setup.

#### **Auto Lip Sync**

If you connect the unit to a TV that supports the Auto Lip Sync function, it can automatically correct delay between the audio and video.

### B

#### **Bluetooth**

Bluetooth is a short-distance wireless communication technology used for connecting handheld devices several meters apart. This enables notebook computers, PDA s, mobile phones, etc. to connect without a cable for transmitting audio and data.

### D

#### **Deep Color**

An imaging technology supported by HDMI. Unlike RGB, which uses 8 bits (256 shades) per color, it can use 10 bits (1024 shades), 12 bits (4096 shades), or 16 bits (65536 shades) to produce colors in higher definition.

Both devices linked via HDMI must support Deep Color.

#### **DLNA**

DLNA and DLNA CERTIFIED are trademarks and/or service marks of Digital Living Network Alliance. Some contents may not be compatible with other DLNA CERTIFIED® products.

#### **Dolby Digital**

Dolby Digital is a multi-channel digital signal format developed by Dolby Laboratories.

A total of 5.1 channels are played: 3 front channels ("FL", "FR" and "C"), 2 surround channels ("SL" and "SR") and the "LFE" channel for low frequencies.

Because of this, there is no crosstalk between channels and a realistic sound field with a "three-dimensional" feeling (sense of distance, movement and positioning) is achieved. This delivers a thrilling surround sound experience in the home.

#### **Dolby Digital Plus**

Dolby Digital Plus is an improved Dolby Digital signal format that is compatible with up to 7.1 channels of discrete digital sound and also improves sound quality thanks to extra data bit rate performance. It is upwardly compatible with conventional Dolby Digital, so it offers greater flexibility in response to the source signal and the conditions of the playback device.

#### **Dolby Pro Logic II**

Dolby Pro Logic II is a matrix decoding technology developed by Dolby Laboratories.

Regular music such as that on CDs is encoded into 5 channels to achieve an excellent surround effect. The surround channel signals are converted into stereo and full band signals (with a frequency response of 20 Hz to 20 kHz or greater) to create a "three-dimensional" sound image offering a rich sense of presence for all stereo sources.

#### **Dolby TrueHD**

Dolby TrueHD is a high definition audio technology developed by Dolby Laboratories, using lossless coding technology to faithfully reproduce the sound of the studio master.

This format provides the facility to support up to 8 audio channels with a sampling frequency of 96 kHz/24 bit resolution and up to 6 audio channels with a sampling frequency of 192 kHz/24 bit resolution. Dolby TrueHD is adopted for applications that put very high importance on sound quality.

#### **Downmix**

This function converts the number of channels of surround audio to a lower number of channels and plays back according to the system's configuration.

#### **DTS**

This is an abbreviation of Digital Theater System, which is a digital audio system developed by DTS.

DTS delivers a powerful and dynamic surround sound experience, and is found in the world's finest movie theaters and screening rooms.

#### **DTS 96/24**

DTS 96/24 is a digital audio format enabling high sound quality playback in 5.1 channels with a sampling frequency of 96 kHz and 24 bit quantization on DVD-Video.

#### **DTS Digital Surround**

DTS Digital Surround is the standard digital surround format of DTS, Inc., compatible with a sampling frequency of 44.1 or 48 kHz and up to 5.1 channels of digital discrete surround sound.

#### **DTS Express**

DTS Express is an audio format supporting low bit rates (max. 5.1 channels, 24 to 256 kbps).

#### **DTS-HD**

This audio technology provides higher sound quality and enhanced functionality than the conventional DTS and is adopted as an optional audio for Blu-ray Disc. This technology supports multi-channel, high data transfer speed, high sampling frequency, and lossless audio playback. Maximum 7.1-channels are supported in Blu-ray Disc.

#### **DTS-HD High Resolution Audio**

DTS-HD High Resolution Audio is an improved version of the conventional DTS, DTS-ES and DTS 96/24 signals formats, compatible with sampling frequencies of 96 or 48 kHz and up to 7.1 channels of discrete digital sound. High data bit rate performance provides high quality sound. This format is fully compatible with conventional products, including conventional DTS digital surround 5.1-channel data.

#### **DTS-HD Master Audio**

DTS-HD Master Audio is a lossless audio format created by Digital Theater System (DTS). This format provides the facility to support up to 8 audio channels with a sampling frequency of 96 kHz/24 bit resolution and up to 6 audio channels with a sampling frequency of 192 kHz/24 bit resolution. It is fully compatible with conventional products, including conventional DTS digital surround 5.1-channel data.

#### **DTS NEO:6™ Surround**

DTS NEO:6™ is a matrix decoding technology for achieving 6.1-channel surround playback with 2-channel sources. It includes "DTS NEO:6 Cinema" suited for playing movies and "DTS NEO:6 Music" suited for playing music.

#### **Dynamic range**

The difference between the maximum undistorted sound level and the minimum discernible level above the noise emitted by the device.

**F****FLAC**

FLAC stands for Free lossless Audio Codec, and is a lossless free audio file format. Lossless means that the audio is compressed without any loss in quality. The FLAC license is as shown below.

Copyright (C) 2000, 2001, 2002, 2003, 2004, 2005, 2006, 2007, 2008, 2009 Josh Coalson

Redistribution and use in source and binary forms, with or without modification, are permitted provided that the following conditions are met:

- Redistributions of source code must retain the above copyright notice, this list of conditions and the following disclaimer.
- Redistributions in binary form must reproduce the above copyright notice, this list of conditions and the following disclaimer in the documentation and/or other materials provided with the distribution.
- Neither the name of the Xiph.org Foundation nor the names of its contributors may be used to endorse or promote products derived from this software without specific prior written permission. THIS SOFTWARE IS PROVIDED BY THE COPYRIGHT HOLDERS AND CONTRIBUTORS "AS IS" AND ANY EXPRESS OR IMPLIED WARRANTIES, INCLUDING, BUT NOT LIMITED TO, THE IMPLIED WARRANTIES OF MERCHANTABILITY AND FITNESS FOR A PARTICULAR PURPOSE ARE DISCLAIMED. IN NO EVENT SHALL THE FOUNDATION OR CONTRIBUTORS BE LIABLE FOR ANY DIRECT, INDIRECT, INCIDENTAL, SPECIAL, EXEMPLARY, OR CONSEQUENTIAL DAMAGES (INCLUDING, BUT NOT LIMITED TO, PROCUREMENT OF SUBSTITUTE GOODS OR SERVICES; LOSS OF USE, DATA, OR PROFITS; OR BUSINESS INTERRUPTION) HOWEVER CAUSED AND ON ANY THEORY OF LIABILITY, WHETHER IN CONTRACT, STRICT LIABILITY, OR TORT (INCLUDING NEGLIGENCE OR OTHERWISE) ARISING IN ANY WAY OUT OF THE USE OF THIS SOFTWARE, EVEN IF ADVISED OF THE POSSIBILITY OF SUCH DAMAGE.

**H****HDCP**

When transmitting digital signals between devices, this copyright protection technology encrypts the signals to prevent content from being copied without authorization.

**HDMI**

This is an abbreviation of High-Definition Multimedia Interface, which is an AV digital interface that can be connected to a TV or amplifier. Video signals and audio signals can be connected using a single cable.

**I****iTunes**

iTunes is the name of the multimedia player provided by Apple Inc. It enables management and playback of multimedia contents including music and movies. iTunes supports many main file formats including AAC, WAV, and MP3.

**L****LFE**

This is an abbreviation of Low Frequency Effect, which is an output channel that emphasizes low frequency effect sound. Surround audio is intensified by outputting 20 Hz to 120 Hz deep bass to the system subwoofer(s).

**M****MAIN ZONE**

The room where this unit is placed is called the MAIN ZONE.

**MP3 (MPEG Audio Layer-3)**

This is an internationally standardized audio data compression scheme, using the "MPEG-1" video compression standard. It compresses the data volume to about one eleventh its original size while maintaining sound quality equivalent to a music CD.

**MPEG (Moving Picture Experts Group), MPEG-2, MPEG-4**

These are the names for digital compression format standards used for the encoding of video and audio. Video standards include "MPEG-1 Video", "MPEG-2 Video", "MPEG-4 Visual", "MPEG-4 AVC". Audio standards include "MPEG-1 Audio", "MPEG-2 Audio", "MPEG-4 AAC".

**P****Pairing**

Pairing is an operation required for settings to connect two Bluetooth devices. Pairing enables Bluetooth devices to access each other.

**Progressive (sequential scanning)**

This is a scanning system of the video signal that displays 1 frame of video as one image. Compared to the interlace system, this system provides images with less flickering and jagged edges.

**Protection Circuit**

This is a function to prevent damage to devices within the power supply when an abnormality such as an overload, excess voltage occurs or over temperature for any reason.

In this unit, the power indicator blinks and the unit enters standby mode when an abnormality occurs.

**S****Sampling frequency**

Sampling involves taking a reading of a sound wave (analog signal) at regular intervals and expressing the height of the wave at each reading in digitized format (producing a digital signal).

The number of readings taken in one second is called the "sampling frequency". The larger the value, the closer the reproduced sound is to the original.

**Speaker impedance**

This is an AC resistance value, indicated in  $\Omega$  (ohms). Greater power can be obtained when this value is smaller.

**sYCC601 color**

Like "x.v.Color", each of these color spaces defines a palette of available colors that is larger than the traditional RGB color model.

**V****vTuner**

This is a free online content server for Internet Radio. Note that usage fees are included in upgrade costs.

For inquiries about this service, visit the vTuner site below.

vTuner website: <http://www.radiomarantz.com>

This product is protected by certain intellectual property rights of Nothing Else Matters Software and BridgeCo. Use or distribution of such technology outside of this product is prohibited without a license from Nothing Else Matters Software and BridgeCo or an authorized subsidiary.

**W****Windows Media DRM**

This is a copyright protection technology developed by Microsoft.

Content providers are using the digital rights management technology for Windows Media contained in this device (WM-DRM) to protect the integrity of their content (Secure Content) so that their intellectual property, including copyright, in such content is not misappropriated. This device uses WM-DRM software to play Secure Content (WM-DRM Software). If the security of the WM-DRM Software in this device has been compromised, owners of Secure Content (Secure Content Owners) may request that Microsoft revoke the WM-DRM Software's right to acquire new licenses to copy, display and/or play Secure Content. Revocation does not alter the WM-DRM Software's ability to play unprotected content. A list of revoked WM-DRM Software is sent to your device whenever you download a license for Secure Content from the Internet or from a PC. Microsoft may, in conjunction with such license, also download revocation list onto your device on behalf of Secure Content Owners.

**Windows Media Player Ver.11 or later**

This is a media player distributed free of charge by Microsoft Corporation.

It can play playlists created with Ver.11 or later of Windows Media Player, as well as WMA, DRM WMA, WAV, and other files.

**WMA (Windows Media Audio)**

This is audio compression technology developed by Microsoft Corporation.

WMA data can be encoded using Windows Media® Player.

To encode WMA files, only use applications authorized by Microsoft Corporation. If you use an unauthorized application, the file may not work properly.

**X****x.v.Color**

This function lets HDTVs display colors more accurately. It enables display with natural, vivid colors. "x.v.Color" is trademark of Sony Corporation.

# Troubleshooting

If a problem should arise, first check the following:

1. Are the connections correct?

2. Is the set being operated as described in the owner's manual?

3. Are the other devices operating properly?

If this unit does not operate properly, check the items listed in the table below. Should the problem persist, there may be a malfunction.

In this case, disconnect the power immediately and contact your store of purchase.

## [General]

Symptom	Cause/Solution	Page
Power does not turn on.	<ul style="list-style-type: none"> <li>Check whether the power plug is correctly inserted into the power outlet.</li> <li>The protection circuit is active. Disconnect the power plug from the electric outlet, wait 5 to 10 seconds and then insert it back into the outlet.</li> </ul>	<a href="#">22</a> <a href="#">131</a>
Power automatically switches to standby mode.	<ul style="list-style-type: none"> <li>The sleep timer is set. Turn on the power again, or change the sleep timer settings.</li> <li>"Auto Standby" is triggered when there is no operation for a set amount of time. To disable "Auto Standby", set "Auto Standby" on the menu to "Off".</li> </ul>	<a href="#">84</a> <a href="#">115</a>
Display is off.	<ul style="list-style-type: none"> <li>Set "Display" on the menu to something other than "Off".</li> </ul>	<a href="#">115</a>
The power indicator is blinking red in intervals of approximately 2 seconds.	<ul style="list-style-type: none"> <li>Due to the temperature rise within this unit, the protection circuit is working. Please turn off power once, and re-apply the power after the temperature has fallen sufficiently.</li> <li>Please re-install this unit in a place having good ventilation.</li> </ul>	<a href="#">131</a> -
The power indicator is blinking red in intervals of approximately 0.5 seconds.	<ul style="list-style-type: none"> <li>Please use speakers which have the specified impedance.</li> <li>The protection circuit has been activated because the speaker cable core wires are touching, a core wire has come loose from the terminal, or a core wire is touching the rear panel of this unit. After unplugging the power cord, take corrective action such as firmly re-twisting the core wire or taking care of the terminal, and then reconnect the wire.</li> </ul>	<a href="#">79</a> <a href="#">79</a>
After turning on the power, the power indicator is blinking red in intervals of approximately 0.5 seconds.	<ul style="list-style-type: none"> <li>This unit's amplifier circuit has failed. Turn off the power and please contact the Marantz service adviser.</li> </ul>	-
Set does not operate properly.	<ul style="list-style-type: none"> <li>Reset the microprocessor. Note that re-setting the microprocessor restores all pre-configured settings to the factory defaults.</li> </ul>	<a href="#">136</a>

## [HDMI]

Symptom	Cause/Solution	Page
No audio is output with HDMI connection.	<ul style="list-style-type: none"> <li>Check the connection of the HDMI connectors.</li> <li>When outputting HDMI audio from the speakers, set "HDMI Audio Out" on the menu to "AVR".</li> <li>When outputting HDMI audio from a TV, set "HDMI Audio Out" on the menu to "TV".</li> </ul>	<a href="#">9, 10</a> <a href="#">100</a> <a href="#">100</a>
No video is output with HDMI connection.	<ul style="list-style-type: none"> <li>Check the connection of the HDMI connectors.</li> <li>Set the input source to match the connected HDMI connector.</li> <li>Check whether the TV is compatible with copyright protection (HDCP). If connected to a device not compatible with HDCP, video will not be output correctly.</li> </ul>	<a href="#">9, 10</a> <a href="#">9, 10, 30</a> <a href="#">11</a>
When the following operations are performed on devices compatible with HDMI control, the same operations occur on this unit. <ul style="list-style-type: none"> <li>Power ON/OFF</li> <li>Switching audio output devices</li> <li>Adjust volume</li> <li>Switch input source</li> </ul>	<ul style="list-style-type: none"> <li>Set "HDMI Control" in the menu to "Off".</li> </ul> Furthermore, if you do not want to link the power off operation with devices compatible with HDMI control, set "Power Off Control" in the menu to "Off".	<a href="#">83, 100</a>

## [Video]

Symptom	Cause/Solution	Page
No picture appears.	<ul style="list-style-type: none"> <li>Check the connection between the video output terminal of this unit and the input terminal of the TV.</li> <li>Match the input settings to the input terminal of the TV connected to this unit.</li> </ul>	<a href="#">9</a> -

**[Audio]**

Symptom	Cause/Solution	Page
Audio is not output.	<ul style="list-style-type: none"> <li>• Check the connections for all devices.</li> <li>• Check the speaker connections and configurations.</li> <li>• Check whether the audio device power is turned on.</li> <li>• Adjust the master volume.</li> <li>• Cancel the mute mode.</li> <li>• Check the connection with the playback device and select the proper input source.</li> <li>• Match the input mode and the terminal assigned to be the digital input terminal.</li> <li>• Disconnect the headphones. No sound is output from the speakers when headphones are connected.</li> </ul>	<a href="#">9, 10, 13, 14, 15, 16, 17, 18, 19, 20, 21, 22, 82</a> <a href="#">81</a> – <a href="#">31</a> <a href="#">31</a> <a href="#">30</a> <a href="#">105</a> <a href="#">120</a>
The volume does not increase.	<ul style="list-style-type: none"> <li>• The maximum volume is set too low. Set the maximum volume using "Limit" on the menu.</li> <li>• Power for external devices connected to the output connectors of the unit may not be turned on. Check the power of connected external devices.</li> </ul>	<a href="#">96</a> –
No sound is produced from surround speakers.	<ul style="list-style-type: none"> <li>• Check if the surround speakers are connected to the SURROUND terminals.</li> </ul>	–
No sound is produced from subwoofer.	<ul style="list-style-type: none"> <li>• Check the subwoofer connections.</li> <li>• Turn on the subwoofer's power.</li> <li>• Set "Speaker Config." – "Subwoofer" on the menu to "Yes".</li> <li>• If "Front" and "Center" for "Speaker Config." are set to "Large", and "Subwoofer Mode" is set to "LFE", no sound may be output from the subwoofers, depending on the input signal or selected sound mode.</li> </ul>	<a href="#">81</a> – <a href="#">107</a> <a href="#">107, 109</a>
DTS sound is not output.	<ul style="list-style-type: none"> <li>• Set "Decode Mode" on the menu to "Auto" or "DTS".</li> </ul>	<a href="#">105</a>
Dolby TrueHD, DTS-HD, Dolby Digital Plus audio is not output.	<ul style="list-style-type: none"> <li>• Make HDMI connections.</li> </ul>	<a href="#">9, 10</a>

Symptom	Cause/Solution	Page
Dolby PLII mode or DTS NEO:6 mode cannot be selected.	<ul style="list-style-type: none"> <li>• Check that "Speaker Config." – "Center" or "Surround" is set to other than "None". If the speaker system is 2.0/2.1-channel, this sound mode cannot be selected.</li> <li>• When headphones are used, Dolby PLII or DTS NEO:6 cannot be selected.</li> </ul>	<a href="#">107</a> –
Audyssey MultEQ®, Audyssey Dynamic EQ® and Audyssey Dynamic Volume® cannot be selected.	<ul style="list-style-type: none"> <li>• Switch the sound mode to other than "DIRECT" or "PURE DIRECT".</li> <li>• When headphones are used, Audyssey MultEQ®, Audyssey Dynamic EQ® and Audyssey Dynamic Volume® cannot be selected.</li> </ul>	<a href="#">72</a> –
Audyssey Dynamic EQ® and Audyssey Dynamic Volume® cannot be selected.	<ul style="list-style-type: none"> <li>• Run Audyssey® Setup.</li> </ul>	<a href="#">23</a>
"M-DAX" cannot be selected.	<ul style="list-style-type: none"> <li>• Check that an analog signal or PCM signal (Sample Rate=44.1/48 kHz) is input. For playback of multichannel signals such as Dolby Digital or DTS surround, "M-DAX" cannot be used.</li> <li>• Switch the sound mode to other than "DIRECT" or "PURE DIRECT".</li> </ul>	<a href="#">96</a> <a href="#">72</a>

**[FM/AM]**

Symptom	Cause/Solution	Page
Reception fails, or there is a lot of noise or distortion.	<ul style="list-style-type: none"> <li>• Change the antenna orientation or position.</li> <li>• Separate the AM loop antenna from the unit.</li> <li>• Use an FM outdoor antenna.</li> <li>• Separate the antenna from other connection cables.</li> </ul>	<a href="#">19</a> <a href="#">19</a> <a href="#">19</a> <a href="#">19</a>







**[iPod / USB memory device / Internet Radio / Media Server / Flickr / Pandora / SiriusXM / Spotify]**

Symptom	Cause/Solution	Page
iPod cannot be played.	<ul style="list-style-type: none"> <li>Some iPods do not support being used connected directly to the USB port.</li> </ul>	<a href="#">17</a>
The file names are not displayed properly ("...", etc.).	<ul style="list-style-type: none"> <li>Characters that cannot be displayed are used. This is not a malfunction. On this unit, characters that cannot be displayed are replaced with a "." (period).</li> <li>Invalid tags are used for files within the USB memory device connected to this unit. Use tags that are supported by this unit.</li> </ul>	– <a href="#">35</a>
When a USB memory device is connected, "No Connection" is displayed.	<ul style="list-style-type: none"> <li>The set cannot recognize a USB memory device. Check the connection.</li> <li>This unit supports mass storage class and MTP-compatible USB memory devices. It will not recognize other USB memory devices.</li> <li>A USB memory device that the set cannot recognize is connected. This is not a malfunction. Marantz does not guarantee that all USB memory devices will operate or receive power.</li> <li>USB memory device is connected via USB hub. Connect the USB memory device directly to the USB port.</li> <li>The unit supports file structures with up to 8 levels and a total maximum of 5000 subfolders and files per 1 folder. Change the file structure of the USB memory device if necessary.</li> </ul>	<a href="#">17</a> – – – <a href="#">35</a>
Files on a USB memory device cannot be played.	<ul style="list-style-type: none"> <li>The USB memory device format should be set to FAT16 or FAT32. For details, refer to the USB memory device's operating instructions.</li> <li>If the USB memory device is divided into multiple partitions, only files in partition one can be played.</li> <li>Files are stored in a non-compatible format. Record the files in a compatible format.</li> <li>You are attempting to play a file that is copyright protected. Files that are copyright protected cannot be played on this unit.</li> </ul>	– – <a href="#">35</a> <a href="#">35</a>
Internet Radio cannot be played.	<ul style="list-style-type: none"> <li>LAN cable is not properly connected or network is disconnected. Check the connection status.</li> <li>Program is being broadcast in non-compatible format. Only Internet Radio programs in MP3 and WMA can be played on this unit.</li> <li>The firewall of the PC or router has been activated. Check the firewall settings of the connected PC or router.</li> <li>Radio station is not currently broadcasting. Choose a radio station that is currently broadcasting.</li> <li>IP address is wrong. Check the set's IP address.</li> <li>Some radio stations may go silent at certain times of the day. In this case, no audio is output even when a station is received. Try again later, or switch to another radio station.</li> </ul>	<a href="#">21</a> <a href="#">47</a> – <a href="#">47</a> <a href="#">111</a> –

Symptom	Cause/Solution	Page
Files stored on a computer cannot be played.	<ul style="list-style-type: none"> <li>Files are stored in a non-compatible format. Record in a compatible format.</li> <li>You are attempting to play a file that is copyright protected. Files that are copyright protected cannot be played on this unit.</li> <li>Set and computer are connected by USB cable. The set's USB port cannot be used for connection to a computer.</li> <li>Media sharing settings are not correct. Change media sharing settings so that the unit can access the folders on your computer.</li> </ul>	<a href="#">50</a> <a href="#">50</a> – <a href="#">51</a>
Music stored on a NAS cannot be played.	<ul style="list-style-type: none"> <li>If you use a NAS in conformity with the DLNA standard, enable the DLNA server function in the NAS setting.</li> <li>If you use a NAS that does not conform with the DLNA standard, play the music via a PC. Set Windows Media Player's media sharing function and add NAS to the selected play folder.</li> <li>If connection is restricted, set audio equipment as the connection target.</li> </ul>	– <a href="#">51</a> –
Server is not found, or it is not possible to connect to the server.	<ul style="list-style-type: none"> <li>The computer's or router's firewall is activated. Check the computer's or router's firewall settings.</li> <li>Computer's power is not turned on. Turn on the power.</li> <li>Server is not running. Launch the server.</li> <li>Set's IP address is wrong. Check the set's IP address.</li> </ul>	– – – <a href="#">111</a>
Cannot connect to preset or favorite radio stations.	<ul style="list-style-type: none"> <li>Radio station is not currently broadcasting. Wait a while before trying again.</li> <li>Radio station is not currently in service. It is not possible to connect to radio stations that are no longer in service.</li> </ul>	– –
A list of broadcasting stations is not displayed.	<ul style="list-style-type: none"> <li>Connection to the network is unstable. Reconnect to the network or redo the "Network" setting in the menu.</li> </ul>	<a href="#">21</a> , <a href="#">110</a>
For some radio stations, "Radio station server full" or "Connection down" is displayed and station cannot be connected to.	<ul style="list-style-type: none"> <li>Station is congested or not currently broadcasting. Wait a while before trying again.</li> </ul>	–

Symptom	Cause/Solution	Page
Sound is broken during playback.	<ul style="list-style-type: none"> <li>• Network or USB memory device's signal transfer speed is slow or communications lines or radio station is congested. This is not a malfunction. When playing broadcast data with a high bit rate, the sound may be broken, depending on the communications conditions.</li> </ul>	–
Sound quality is poor or noise is heard during play.	<ul style="list-style-type: none"> <li>• File being played has a low bit rate. This is not a malfunction.</li> </ul>	–
Cannot login to Pandora. ("Email address" or "Password" is displayed.)	<ul style="list-style-type: none"> <li>• Login information is incorrect. Check if the "Email address" for Pandora has been properly entered. Re-enter the "Password". (Password is not displayed.) <a href="http://www.pandora.com/marantz">http://www.pandora.com/marantz</a></li> </ul>	<a href="#">57</a>

#### [AirPlay]

Symptom	Cause/Solution	Page
The AirPlay icon  is not displayed in iTunes or on the iPhone/iPod touch/iPad.	<ul style="list-style-type: none"> <li>• This unit and the computer or iPhone/iPod touch/iPad are not connected to the same network (LAN). Connect the computer or iPhone/iPod touch/iPad to the same network as this unit.</li> <li>• iTunes or the iPhone/iPod touch/iPad do not have firmware that supports AirPlay installed. Update to the latest firmware.</li> </ul>	<a href="#">21</a> –
No sound.	<ul style="list-style-type: none"> <li>• The volume in iTunes or on the iPhone/iPod touch/iPad is set to the minimum setting. Adjust the volume to the optimum level.</li> <li>• This unit is not selected in the screen that is displayed when iTunes or the iPhone/iPod touch/iPad is started. Start iTunes or switch on the iPhone/iPod touch/iPad, click the AirPlay icon  in the displayed screen, and select this unit.</li> <li>• AirPlay playback has not started. Click the  button in iTunes or press the  button on the iPhone/iPod touch/iPad.</li> </ul>	– <a href="#">70</a> –
When using AirPlay with the iPhone/iPod touch/iPad, the sound suffers from intermittent breaks or AirPlay does not function.	<ul style="list-style-type: none"> <li>• Quit the application running in the background of the iPhone/iPod touch/iPad, and then play using AirPlay.</li> <li>• When playing via a wireless connection, outside conditions may affect the unit. To remedy this, change the network environment, e.g. shorten the distance to the wireless LAN access point.</li> <li>• Update the iPhone/iPod touch/iPad application or iTunes to the latest version.</li> </ul>	– – –

#### [M-XPort]

Symptom	Cause/Solution	Page
Audio is not output when a wireless receiver (RX101 is connected).	<ul style="list-style-type: none"> <li>• Check that the Bluetooth device and Wireless receiver (RX101) are correctly paired.</li> </ul>	<a href="#">20</a> , <a href="#">130</a> , <a href="#">131</a>

#### [Remote control unit]

Symptom	Cause/Solution	Page
The set cannot be operated with the remote control unit.	<ul style="list-style-type: none"> <li>• Batteries are worn out. Replace with new batteries.</li> <li>• Operate the remote control unit within a distance of about 23 ft/7 m from this unit and at an angle of within 30°.</li> <li>• Remove any obstacle between this unit and the remote control unit.</li> <li>• Insert the batteries in the proper direction, checking the ⊕ and ⊖ marks.</li> <li>• The set's remote control sensor is exposed to strong light (direct sunlight, inverter type fluorescent bulb light, etc.). Move the set to a place in which the remote control sensor will not be exposed to strong light.</li> </ul>	<a href="#">124</a> <a href="#">124</a> <a href="#">124</a> <a href="#">124</a> <a href="#">124</a>

## Resetting the microprocessor

Perform this procedure if the display is abnormal or if operations cannot be performed.  
Note that when the microprocessor is reset, all the settings are reset to their default values.

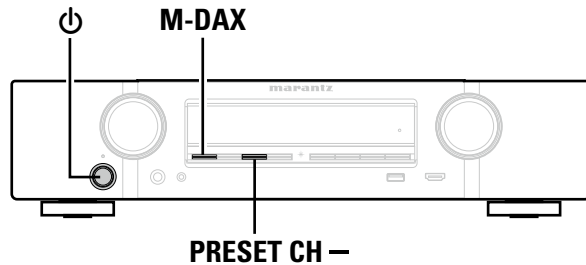

**1** Turn off the power using .

**2** Press  while simultaneously pressing **M-DAX** and **PRESET CH -**.

**3** Once the display starts flashing at intervals of about 1 second, release the two buttons.



If in step 3 the display does not flash at intervals of about 1 second, start over from step 1.

## Specifications

### Audio section

#### Power amplifier

##### Rated output:

Front:

50 W + 50 W (8 Ω/ohms, 20 Hz – 20 kHz with 0.08 % T.H.D.)  
60 W + 60 W (6 Ω/ohms, 1 kHz with 0.7 % T.H.D.)

Center:

50 W (8 Ω/ohms, 20 Hz – 20 kHz with 0.08 % T.H.D.)  
60 W (6 Ω/ohms, 1 kHz with 0.7 % T.H.D.)

Surround:

50 W + 50 W (8 Ω/ohms, 20 Hz – 20 kHz with 0.08 % T.H.D.)  
60 W + 60 W (6 Ω/ohms, 1 kHz with 0.7 % T.H.D.)

6 – 16 Ω/ohms

#### Output connectors:

#### Analog

##### Input sensitivity/Input impedance:

130 mV/47 kΩ/kohms

##### Frequency response:

10 Hz – 100 kHz — +1, –3 dB (DIRECT mode)

##### S/N:

98 dB (IHF–A weighted, DIRECT mode)

### Video section

#### Standard video connectors

##### Input sensitivity/Input impedance:

1 Vp-p, 75 Ω/ohms

##### Frequency response:

5 Hz – 10 MHz — 0, –3 dB

### Tuner section

[FM]

[AM]

(Note: μV at 75 Ω/ohms, 0 dBf =  $1 \times 10^{-15}$  W)

#### Receiving Range:

87.5 MHz – 107.9 MHz

520 kHz – 1710 kHz

#### Usable Sensitivity:

1.2 μV (12.8 dBf)

18 μV

#### 50 dB Quietening Sensitivity:

MONO 2.8 μV (20.2 dBf)

#### S/N :

MONO 70 dB (IHF–A weighted, DIRECT mode)

STEREO 67 dB (IHF–A weighted, DIRECT mode)

#### Total harmonic Distortion:

MONO 0.7 % (1 kHz)

STEREO 1.0 % (1 kHz)

### General

#### Power supply:

AC 120 V, 60 Hz

#### Power consumption:

180 W

#### Power consumption in standby mode:

0.2 W

#### Power consumption in CEC standby mode:

0.5 W

#### Power consumption in network standby mode:

2.7 W

For purposes of improvement, specifications and design are subject to change without notice.

## Index

### Numerics

2.1-channel	81
3D	11
5.1-channel	78, 81

### A

A2DP	20, 130
Accessories	2
Add New Feature	118
Adjust EQ	98
Adjusting the master volume	31
Adobe RGB color / Adobe YCC601 color	130
AirPlay	70, 130
ALAC	130
AM loop antenna	19
App Store	130
ARC	8
Audio	93
Audio Delay	96
Audyssey	97
Audyssey Dynamic EQ®	97, 130
Audyssey Dynamic Volume®	97, 130
Audyssey MultEQ®	97, 130
Audyssey® Setup	23
Auto Lip Sync	100, 130
Auto Preset	43
Auto Standby	115

### B

Bass	95, 109
Bluetooth	20, 130

### C

Cable	
Audio cable	12
Coaxial digital cable	12
HDMI cable	9, 10
LAN cable	12
Optical cable	12
Speaker cable	80
Subwoofer cable	80
Video cable	12
Center Image	95

Center Width	95
Characters	92
Check Results	29
Condensation	3
Connection	
Blu-ray Disc player	10
Cable TV	14
CD player	10, 18
DVD player	10, 15, 16
FM/AM	19
Game console	10
HDMI	7
Home network (LAN)	21
iPod (USB)	17
Media player	10, 16
Power cord	22
REMOTE CONTROL connectors	82
Satellite tuner	14
Set-top box	10, 14
Speaker	79
TV	9, 13
USB memory device	17
Video camcorder	10
Wireless receiver	20
Content Type	11
Crossovers	108
Curve Copy	98

### D

Decode Mode	105
Deep Color	11, 130
Diagnostics	113
Dialog Level	94
Dimension	95
Direct Tune	40
Display	115, 121
Distances	107
DLNA	130
Dolby	
Dolby Digital	76, 130
Dolby Digital EX	130
Dolby Digital Plus	76, 130
Dolby Pro Logic II	76, 130
Dolby TrueHD	76, 130
Downmix	130

DTS	130
DTS 96/24	76, 130
DTS Digital Surround	130
DTS-ES Discrete 6.1	130
DTS Express	76, 130
DTS-HD	76, 130
DTS-HD High Resolution Audio	130
DTS-HD Master Audio	130
DTS Neo:6	76
DTS NEO:6™ Surround	130
Dual backup memory function	86
Dynamic Comp.	94
Dynamic EQ	97
Dynamic range	130
Dynamic Volume	97

### E

Edit Name	111
Error messages (Audyssey® Setup)	28

### F

Firmware	117
FLAC	131
Flickr	54, 55
FM/AM	38
FM indoor antenna	19
Format	101
Friendly Name	111
Front Display	115
Front Panel	120

### G

General	114
---------	-----

### H

HDCP	11, 131
HDMI	7, 11, 131
HDMI Audio Out	100
HDMI Control	83, 100
HDMI Pass Through	100
HDMI Setup	100
Headphones	120
Hide Sources	105
Home Theater EQ	94

### I

Info	101
Information	111, 116
Audio	116
Firmware	116
Notifications	116
Status	116
Video	116
Input Assign	103
Input Mode	105
Inputs	102
Input Select	105
Input signal	128
Inputting characters	92
Internet Access	113
IP Control	111
iPod Browse Mode	33
iTunes	131

### L

Language	115
Level	94
Levels	108
LFE	131
Limit	96
Listening mode	72
Listening position	23
Lock	118
Loudness Mngmt	94
Low Frequency	94

### M

Maintenance Mode	113
MAIN ZONE	131
Manual EQ	98
Manual Setup	107
M-DAX	96
Menu map	89
Mode	96
MP3	131
MPEG	131
MultEQ®	97
Mute Level	96

## **N**

Network .....	29, 110
Notifications .....	117
Now Playing .....	101

## **O**

On Screen Disp. ....	101
----------------------	-----

## **P**

Pairing .....	131
Pandora® .....	54, 57
Panel lock function .....	87
Panorama .....	95
Pass Through Source .....	100
Physical Connection .....	113
Playback	
ALAC .....	35, 50
Auto surround .....	73, 76
Blu-ray Disc player .....	31
CD player .....	31
Direct .....	72, 76
DVD player .....	31
FLAC .....	35, 50
Flickr .....	55
FM/AM .....	38
Internet Radio .....	47
iPod (USB) .....	32
JPEG .....	35, 50
MP3 .....	35, 47, 50
MPEG-4 AAC .....	35, 50
NAS .....	50
Original listening mode .....	76
Pandora® .....	57
PC .....	50
Pure Direct .....	73, 76
SiriusXM .....	61
Spotify .....	63
Stereo .....	76
USB memory device .....	35
WAV .....	35, 50
WMA .....	35, 47, 50
Power Off Control .....	100
Power On Level .....	96
Preset Memory .....	41
Preset Name .....	44
Preset Skip .....	45
Progressive .....	131
Protection circuit .....	131

## **R**

Random .....	34, 66
Rear panel .....	122
Reference Level Offset .....	97
Remote control unit .....	123
Inserting the batteries .....	124
Remote lock function .....	88
Remove from Fav. ....	68
Repeat .....	34, 65
Resetting the microprocessor .....	136
Router Access .....	113

## **S**

Sampling frequency .....	131
Save to Favorite .....	67
Scale .....	96
Selecting the input source .....	30
Settings .....	112
Setup Lock .....	118
SiriusXM .....	54, 61
Sleep timer .....	84
Slideshow .....	68
Slideshow Time .....	68
Sound Mode .....	72, 126
Source Level .....	105
Source Rename .....	105
Speaker	
Connect .....	79
Install .....	78
Set up .....	23
Speaker Config. ....	107
Speaker impedance .....	79, 131
Speakers .....	106
Speaker Select. ....	98
Spotify .....	54, 63
Subwoofer .....	94
Subwoofer Level .....	94
Subwoofer setting .....	24
Surr.Parameter .....	94
sYCC601 color .....	131

## **T**

Text Search .....	65
Tone .....	95
Tone Control .....	95
Trademark .....	125
Treble .....	95
Troubleshooting .....	132
Tune Mode .....	42
Turning off the sound temporarily .....	31
Turning the power on .....	30
TV Format .....	101

## **U**

Update .....	117
Usage Data .....	117

## **V**

Video .....	99
Video Select .....	69
Volume .....	96, 101
vTuner .....	49, 131

## **W**

Web control .....	85
Windows Media DRM .....	131
Windows Media Player .....	131
WMA .....	131

## **X**

x.v.Color .....	131
-----------------	-----

## License

**This section describes software license used for this unit. To maintain the correct content, the original (English) is used.**

### □ Boost

<http://www.boost.org/>

Boost Software License - Version 1.0 - August 17th, 2003

Permission is hereby granted, free of charge, to any person or organization obtaining a copy of the software and accompanying documentation covered by this license (the "Software") to use, reproduce, display, distribute, execute, and transmit the Software, and to prepare derivative works of the Software, and to permit third-parties to whom the Software is furnished to do so, all subject to the following:

The copyright notices in the Software and this entire statement, including the above license grant, this restriction and the following disclaimer, must be included in all copies of the Software, in whole or in part, and all derivative works of the Software, unless such copies or derivative works are solely in the form of machine-executable object code generated by a source language processor.

THE SOFTWARE IS PROVIDED "AS IS", WITHOUT WARRANTY OF ANY KIND, EXPRESS OR IMPLIED, INCLUDING BUT NOT LIMITED TO THE WARRANTIES OF MERCHANTABILITY, FITNESS FOR A PARTICULAR PURPOSE, TITLE AND NON-INFRINGEMENT. IN NO EVENT SHALL THE COPYRIGHT HOLDERS OR ANYONE DISTRIBUTING THE SOFTWARE BE LIABLE FOR ANY DAMAGES OR OTHER LIABILITY, WHETHER IN CONTRACT, TORT OR OTHERWISE, ARISING FROM, OUT OF OR IN CONNECTION WITH THE SOFTWARE OR THE USE OR OTHER DEALINGS IN THE SOFTWARE.

### □ Expat

<http://www.jclark.com/xml/expat.html>

Expat License. Copyright (c) 1998, 1999, 2000 Thai Open Source Software Center Ltd

Permission is hereby granted, free of charge, to any person obtaining a copy of this software and associated documentation files (the "Software"), to deal in the Software without restriction, including without limitation the rights to use, copy, modify, merge, publish, distribute, sublicense, and/or sell copies of the Software, and to permit persons to whom the Software is furnished to do so, subject to the following conditions:

The above copyright notice and this permission notice shall be included in all copies or substantial portions of the Software.

THE SOFTWARE IS PROVIDED "AS IS", WITHOUT WARRANTY OF ANY KIND, EXPRESS OR IMPLIED, INCLUDING BUT NOT LIMITED TO THE WARRANTIES OF MERCHANTABILITY, FITNESS FOR A PARTICULAR PURPOSE AND NON-INFRINGEMENT. IN NO EVENT SHALL THE AUTHORS OR COPYRIGHT HOLDERS BE LIABLE FOR ANY CLAIM, DAMAGES OR OTHER LIABILITY, WHETHER IN AN ACTION OF CONTRACT, TORT OR OTHERWISE, ARISING FROM, OUT OF OR IN CONNECTION WITH THE SOFTWARE OR THE USE OR OTHER DEALINGS IN THE SOFTWARE.

### □ FastDelegate

<http://www.codeproject.com/KB/cpp/FastDelegate.aspx>

THE WORK (AS DEFINED BELOW) IS PROVIDED UNDER THE TERMS OF THIS CODE PROJECT OPEN LICENSE ("LICENSE"). THE WORK IS PROTECTED BY COPYRIGHT AND/OR OTHER APPLICABLE LAW. ANY USE OF THE WORK OTHER THAN AS AUTHORIZED UNDER THIS LICENSE OR COPYRIGHT LAW IS PROHIBITED.

BY EXERCISING ANY RIGHTS TO THE WORK PROVIDED HEREIN, YOU ACCEPT AND AGREE TO BE BOUND BY THE TERMS OF THIS LICENSE. THE AUTHOR GRANTS YOU THE RIGHTS CONTAINED HEREIN IN CONSIDERATION OF YOUR ACCEPTANCE OF SUCH TERMS AND CONDITIONS. IF YOU DO NOT AGREE TO ACCEPT AND BE BOUND BY THE TERMS OF THIS LICENSE, YOU CANNOT MAKE ANY USE OF THE WORK.

- Definitions.
  - "Articles" means, collectively, all articles written by Author which describes how the Source Code and Executable Files for the Work may be used by a user.
  - "Author" means the individual or entity that offers the Work under the terms of this License.
  - "Derivative Work" means a work based upon the Work or upon the Work and other pre-existing works.
  - "Executable Files" refer to the executables, binary files, configuration and any required data files included in the Work.
  - "Publisher" means the provider of the website, magazine, CD-ROM, DVD or other medium from or by which the Work is obtained by You.
  - "Source Code" refers to the collection of source code and configuration files used to create the Executable Files.
  - "Standard Version" refers to such a Work if it has not been modified, or has been modified in accordance with the consent of the Author, such consent being in the full discretion of the Author.
  - "Work" refers to the collection of files distributed by the Publisher, including the Source Code, Executable Files, binaries, data files, documentation, whitepapers and the Articles.
  - "You" is you, an individual or entity wishing to use the Work and exercise your rights under this License.
- Fair Use/Fair Use Rights. Nothing in this License is intended to reduce, limit, or restrict any rights arising from fair use, fair dealing, first sale or other limitations on the exclusive rights of the copyright owner under copyright law or other applicable laws.

3. License Grant. Subject to the terms and conditions of this License, the Author hereby grants You a worldwide, royalty-free, non-exclusive, perpetual (for the duration of the applicable copyright) license to exercise the rights in the Work as stated below:

- You may use the standard version of the Source Code or Executable Files in Your own applications.
- You may apply bug fixes, portability fixes and other modifications obtained from the Public Domain or from the Author. A Work modified in such a way shall still be considered the standard version and will be subject to this License.
- You may otherwise modify Your copy of this Work (excluding the Articles) in any way to create a Derivative Work, provided that You insert a prominent notice in each changed file stating how, when and where You changed that file.
- You may distribute the standard version of the Executable Files and Source Code or Derivative Work in aggregate with other (possibly commercial) programs as part of a larger (possibly commercial) software distribution.
- The Articles discussing the Work published in any form by the author may not be distributed or republished without the Author's consent. The author retains copyright to any such Articles. You may use the Executable Files and Source Code pursuant to this License but you may not repost or republish or otherwise distribute or make available the Articles, without the prior written consent of the Author.

Any subroutines or modules supplied by You and linked into the Source Code or Executable Files this Work shall not be considered part of this Work and will not be subject to the terms of this License.

- Patent License. Subject to the terms and conditions of this License, each Author hereby grants to You a perpetual, worldwide, non-exclusive, no-charge, royalty-free, irrevocable (except as stated in this section) patent license to make, have made, use, import, and otherwise transfer the Work.
- Restrictions. The license granted in Section 3 above is expressly made subject to and limited by the following restrictions:
  - You agree not to remove any of the original copyright, patent, trademark, and attribution notices and associated disclaimers that may appear in the Source Code or Executable Files.
  - You agree not to advertise or in any way imply that this Work is a product of Your own.
  - The name of the Author may not be used to endorse or promote products derived from the Work without the prior written consent of the Author.
  - You agree not to sell, lease, or rent any part of the Work. This does not restrict you from including the Work or any part of the Work inside a larger software distribution that itself is being sold. The Work by itself, though, cannot be sold, leased or rented.

- You may distribute the Executable Files and Source Code only under the terms of this License, and You must include a copy of, or the Uniform Resource Identifier for, this License with every copy of the Executable Files or Source Code You distribute and ensure that anyone receiving such Executable Files and Source Code agrees that the terms of this License apply to such Executable Files and/or Source Code. You may not offer or impose any terms on the Work that alter or restrict the terms of this License or the recipients' exercise of the rights granted hereunder. You may not sublicense the Work. You must keep intact all notices that refer to this License and to the disclaimer of warranties. You may not distribute the Executable Files or Source Code with any technological measures that control access or use of the Work in a manner inconsistent with the terms of this License.
  - You agree not to use the Work for illegal, immoral or improper purposes, or on pages containing illegal, immoral or improper material. The Work is subject to applicable export laws. You agree to comply with all such laws and regulations that may apply to the Work after Your receipt of the Work.
- Representations, Warranties and Disclaimer. THIS WORK IS PROVIDED "AS IS", "WHERE IS" AND "AS AVAILABLE", WITHOUT ANY EXPRESS OR IMPLIED WARRANTIES OR CONDITIONS OR GUARANTEES. YOU, THE USER, ASSUME ALL RISK IN ITS USE, INCLUDING COPYRIGHT INFRINGEMENT, PATENT INFRINGEMENT, SUITABILITY, ETC. AUTHOR EXPRESSLY DISCLAIMS ALL EXPRESS, IMPLIED OR STATUTORY WARRANTIES OR CONDITIONS, INCLUDING WITHOUT LIMITATION, WARRANTIES OR CONDITIONS OF MERCHANTABILITY, MERCHANTABILITY QUALITY OR FITNESS FOR A PARTICULAR PURPOSE, OR ANY WARRANTY OF TITLE OR NON-INFRINGEMENT, OR THAT THE WORK (OR ANY PORTION THEREOF) IS CORRECT, USEFUL, BUG-FREE OR FREE OF VIRUSES. YOU MUST PASS THIS DISCLAIMER ON WHENEVER YOU DISTRIBUTE THE WORK OR DERIVATIVE WORKS.
  - Indemnity. You agree to defend, indemnify and hold harmless the Author and the Publisher from and against any claims, suits, losses, damages, liabilities, costs, and expenses (including reasonable legal or attorneys' fees) resulting from or relating to any use of the Work by You.
  - Limitation on Liability. EXCEPT TO THE EXTENT REQUIRED BY APPLICABLE LAW, IN NO EVENT WILL THE AUTHOR OR THE PUBLISHER BE LIABLE TO YOU ON ANY LEGAL THEORY FOR ANY SPECIAL, INCIDENTAL, CONSEQUENTIAL, PUNITIVE OR EXEMPLARY DAMAGES ARISING OUT OF THIS LICENSE OR THE USE OF THE WORK OR OTHERWISE, EVEN IF THE AUTHOR OR THE PUBLISHER HAS BEEN ADVISED OF THE POSSIBILITY OF SUCH DAMAGES.

9. Termination.

- a. This License and the rights granted hereunder will terminate automatically upon any breach by You of any term of this License. Individuals or entities who have received Derivative Works from You under this License, however, will not have their licenses terminated provided such individuals or entities remain in full compliance with those licenses. Sections 1, 2, 6, 7, 8, 9, 10 and 11 will survive any termination of this License.
  - b. If You bring a copyright, trademark, patent or any other infringement claim against any contributor over infringements You claim are made by the Work, your License from such contributor to the Work ends automatically.
  - c. Subject to the above terms and conditions, this License is perpetual (for the duration of the applicable copyright in the Work). Notwithstanding the above, the Author reserves the right to release the Work under different license terms or to stop distributing the Work at any time; provided, however that any such election will not serve to withdraw this License (or any other license that has been, or is required to be, granted under the terms of this License), and this License will continue in full force and effect unless terminated as stated above.
10. Publisher. The parties hereby confirm that the Publisher shall not, under any circumstances, be responsible for and shall not have any liability in respect of the subject matter of this License. The Publisher makes no warranty whatsoever in connection with the Work and shall not be liable to You or any party on any legal theory for any damages whatsoever, including without limitation any general, special, incidental or consequential damages arising in connection to this license. The Publisher reserves the right to cease making the Work available to You at any time without notice
11. Miscellaneous
- a. This License shall be governed by the laws of the location of the head office of the Author or if the Author is an individual, the laws of location of the principal place of residence of the Author.
  - b. If any provision of this License is invalid or unenforceable under applicable law, it shall not affect the validity or enforceability of the remainder of the terms of this License, and without further action by the parties to this License, such provision shall be reformed to the minimum extent necessary to make such provision valid and enforceable.
  - c. No term or provision of this License shall be deemed waived and no breach consented to unless such waiver or consent shall be in writing and signed by the party to be charged with such waiver or consent.
  - d. This License constitutes the entire agreement between the parties with respect to the Work licensed herein. There are no understandings, agreements or representations with respect to the Work not specified herein. The Author shall not be bound by any additional provisions that may appear in any communication from You. This License may not be modified without the mutual written agreement of the Author and You.

## libogg

<http://www.xiph.org/ogg/>

Copyright (c) 2002, Xiph.org Foundation

Redistribution and use in source and binary forms, with or without modification, are permitted provided that the following conditions are met:

- Redistributions of source code must retain the above copyright notice, this list of conditions and the following disclaimer.
- Redistributions in binary form must reproduce the above copyright notice, this list of conditions and the following disclaimer in the documentation and/or other materials provided with the distribution.
- Neither the name of the Xiph.org Foundation nor the names of its contributors may be used to endorse or promote products derived from this software without specific prior written permission.

THIS SOFTWARE IS PROVIDED BY THE COPYRIGHT HOLDERS AND CONTRIBUTORS "AS IS" AND ANY EXPRESS OR IMPLIED WARRANTIES, INCLUDING, BUT NOT LIMITED TO, THE IMPLIED WARRANTIES OF MERCHANTABILITY AND FITNESS FOR A PARTICULAR PURPOSE ARE DISCLAIMED. IN NO EVENT SHALL THE FOUNDATION OR CONTRIBUTORS BE LIABLE FOR ANY DIRECT, INDIRECT, INCIDENTAL, SPECIAL, EXEMPLARY, OR CONSEQUENTIAL DAMAGES (INCLUDING, BUT NOT LIMITED TO, PROCUREMENT OF SUBSTITUTE GOODS OR SERVICES; LOSS OF USE, DATA, OR PROFITS; OR BUSINESS INTERRUPTION) HOWEVER CAUSED AND ON ANY THEORY OF LIABILITY, WHETHER IN CONTRACT, STRICT LIABILITY, OR TORT (INCLUDING NEGLIGENCE OR OTHERWISE) ARISING IN ANY WAY OUT OF THE USE OF THIS SOFTWARE, EVEN IF ADVISED OF THE POSSIBILITY OF SUCH DAMAGE.

## libvorbis

<http://www.xiph.org/vorbis/>

Copyright (c) 2002-2004 Xiph.org Foundation

Redistribution and use in source and binary forms, with or without modification, are permitted provided that the following conditions are met:

- Redistributions of source code must retain the above copyright notice, this list of conditions and the following disclaimer.
- Redistributions in binary form must reproduce the above copyright notice, this list of conditions and the following disclaimer in the documentation and/or other materials provided with the distribution.
- Neither the name of the Xiph.org Foundation nor the names of its contributors may be used to endorse or promote products derived from this software without specific prior written permission.

THIS SOFTWARE IS PROVIDED BY THE COPYRIGHT HOLDERS AND CONTRIBUTORS "AS IS" AND ANY EXPRESS OR IMPLIED WARRANTIES, INCLUDING, BUT NOT LIMITED TO, THE IMPLIED WARRANTIES OF MERCHANTABILITY AND FITNESS FOR A PARTICULAR PURPOSE ARE DISCLAIMED. IN NO EVENT SHALL THE FOUNDATION OR CONTRIBUTORS BE LIABLE FOR ANY DIRECT, INDIRECT, INCIDENTAL, SPECIAL, EXEMPLARY, OR CONSEQUENTIAL DAMAGES (INCLUDING, BUT NOT LIMITED TO, PROCUREMENT OF SUBSTITUTE GOODS OR SERVICES; LOSS OF USE, DATA, OR PROFITS; OR BUSINESS INTERRUPTION) HOWEVER CAUSED AND ON ANY THEORY OF LIABILITY, WHETHER IN CONTRACT, STRICT LIABILITY, OR TORT (INCLUDING NEGLIGENCE OR OTHERWISE) ARISING IN ANY WAY OUT OF THE USE OF THIS SOFTWARE, EVEN IF ADVISED OF THE POSSIBILITY OF SUCH DAMAGE.

## Tremolo

<http://wss.co.uk/pinknoise/tremolo>

Copyright (C) 2002-2009 Xiph.org Foundation  
Copyright (C) 2009-2010 Robin Watts for Pinknoise Productions Ltd

Redistribution and use in source and binary forms, with or without modification, are permitted provided that the following conditions are met:

- Redistributions of source code must retain the above copyright notice, this list of conditions and the following disclaimer.
- Redistributions in binary form must reproduce the above copyright notice, this list of conditions and the following disclaimer in the documentation and/or other materials provided with the distribution.
- Neither the name of the Xiph.org Foundation nor the names of its contributors may be used to endorse or promote products derived from this software without specific prior written permission.

THIS SOFTWARE IS PROVIDED BY THE COPYRIGHT HOLDERS AND CONTRIBUTORS "AS IS" AND ANY EXPRESS OR IMPLIED WARRANTIES, INCLUDING, BUT NOT LIMITED TO, THE IMPLIED WARRANTIES OF MERCHANTABILITY AND FITNESS FOR A PARTICULAR PURPOSE ARE DISCLAIMED. IN NO EVENT SHALL THE FOUNDATION OR CONTRIBUTORS BE LIABLE FOR ANY DIRECT, INDIRECT, INCIDENTAL, SPECIAL, EXEMPLARY, OR CONSEQUENTIAL DAMAGES (INCLUDING, BUT NOT LIMITED TO, PROCUREMENT OF SUBSTITUTE GOODS OR SERVICES; LOSS OF USE, DATA, OR PROFITS; OR BUSINESS INTERRUPTION) HOWEVER CAUSED AND ON ANY THEORY OF LIABILITY, WHETHER IN CONTRACT, STRICT LIABILITY, OR TORT (INCLUDING NEGLIGENCE OR OTHERWISE) ARISING IN ANY WAY OUT OF THE USE OF THIS SOFTWARE, EVEN IF ADVISED OF THE POSSIBILITY OF SUCH DAMAGE.

## Tremor

<http://wiki.xiph.org/index.php/Tremor>

Copyright (c) 2002, Xiph.org Foundation

Redistribution and use in source and binary forms, with or without modification, are permitted provided that the following conditions are met:

- Redistributions of source code must retain the above copyright notice, this list of conditions and the following disclaimer.
- Redistributions in binary form must reproduce the above copyright notice, this list of conditions and the following disclaimer in the documentation and/or other materials provided with the distribution.
- Neither the name of the Xiph.org Foundation nor the names of its contributors may be used to endorse or promote products derived from this software without specific prior written permission.

THIS SOFTWARE IS PROVIDED BY THE COPYRIGHT HOLDERS AND CONTRIBUTORS "AS IS" AND ANY EXPRESS OR IMPLIED WARRANTIES, INCLUDING, BUT NOT LIMITED TO, THE IMPLIED WARRANTIES OF MERCHANTABILITY AND FITNESS FOR A PARTICULAR PURPOSE ARE DISCLAIMED. IN NO EVENT SHALL THE FOUNDATION OR CONTRIBUTORS BE LIABLE FOR ANY DIRECT, INDIRECT, INCIDENTAL, SPECIAL, EXEMPLARY, OR CONSEQUENTIAL DAMAGES (INCLUDING, BUT NOT LIMITED TO, PROCUREMENT OF SUBSTITUTE GOODS OR SERVICES; LOSS OF USE, DATA, OR PROFITS; OR BUSINESS INTERRUPTION) HOWEVER CAUSED AND ON ANY THEORY OF LIABILITY, WHETHER IN CONTRACT, STRICT LIABILITY, OR TORT (INCLUDING NEGLIGENCE OR OTHERWISE) ARISING IN ANY WAY OUT OF THE USE OF THIS SOFTWARE, EVEN IF ADVISED OF THE POSSIBILITY OF SUCH DAMAGE.

## Mersenne Twister

<http://www.math.sci.hiroshima-u.ac.jp/~m-mat/MT/MT2002/CODES/mt19937ar.c>

Copyright (C) 1997 - 2002, Makoto Matsumoto and Takuji Nishimura,  
All rights reserved.

Redistribution and use in source and binary forms, with or without modification, are permitted provided that the following conditions are met:

1. Redistributions of source code must retain the above copyright notice, this list of conditions and the following disclaimer.
2. Redistributions in binary form must reproduce the above copyright notice, this list of conditions and the following disclaimer in the documentation and/or other materials provided with the distribution.

- The names of its contributors may not be used to endorse or promote products derived from this software without specific prior written permission.

THIS SOFTWARE IS PROVIDED BY THE COPYRIGHT HOLDERS AND CONTRIBUTORS "AS IS" AND ANY EXPRESS OR IMPLIED WARRANTIES, INCLUDING, BUT NOT LIMITED TO, THE IMPLIED WARRANTIES OF MERCHANTABILITY AND FITNESS FOR A PARTICULAR PURPOSE ARE DISCLAIMED. IN NO EVENT SHALL THE COPYRIGHT OWNER OR CONTRIBUTORS BE LIABLE FOR ANY DIRECT, INDIRECT, INCIDENTAL, SPECIAL, EXEMPLARY, OR CONSEQUENTIAL DAMAGES (INCLUDING, BUT NOT LIMITED TO, PROCUREMENT OF SUBSTITUTE GOODS OR SERVICES; LOSS OF USE, DATA, OR PROFITS; OR BUSINESS INTERRUPTION) HOWEVER CAUSED AND ON ANY THEORY OF LIABILITY, WHETHER IN CONTRACT, STRICT LIABILITY, OR TORT (INCLUDING NEGLIGENCE OR OTHERWISE) ARISING IN ANY WAY OUT OF THE USE OF THIS SOFTWARE, EVEN IF ADVISED OF THE POSSIBILITY OF SUCH DAMAGE.

### **zlib**

<http://www.zlib.net/>

zlib.h – interface of the 'zlib' general purpose compression library version 1.2.3, July 18th, 2005

Copyright (C) 1995-2004 Jean-loup Gailly and Mark Adler

This software is provided 'as-is', without any express or implied warranty. In no event will the authors be held liable for any damages arising from the use of this software.

Permission is granted to anyone to use this software for any purpose, including commercial applications, and to alter it and redistribute it freely, subject to the following restrictions:

- The origin of this software must not be misrepresented; you must not claim that you wrote the original software. If you use this software in a product, an acknowledgment in the product documentation would be appreciated but is not required.
- Altered source versions must be plainly marked as such, and must not be misrepresented as being the original software.
- This notice may not be removed or altered from any source distribution.

Jean-loup Gailly [jloup@gzip.org](mailto:jloup@gzip.org), Mark Adler [madler@alumni.caltech.edu](mailto:madler@alumni.caltech.edu)

### **cURL**

<http://curl.haxx.se>

#### COPYRIGHT AND PERMISSION NOTICE

Copyright (c) 1996 - 2011, Daniel Stenberg, <[daniel@haxx.se](mailto:daniel@haxx.se)>.

All rights reserved.

Permission to use, copy, modify, and distribute this software for any purpose with or without fee is hereby granted, provided that the above copyright notice and this permission notice appear in all copies.

THE SOFTWARE IS PROVIDED "AS IS", WITHOUT WARRANTY OF ANY KIND, EXPRESS OR IMPLIED, INCLUDING BUT NOT LIMITED TO THE WARRANTIES OF MERCHANTABILITY, FITNESS FOR A PARTICULAR PURPOSE AND NONINFRINGEMENT OF THIRD PARTY RIGHTS. IN NO EVENT SHALL THE AUTHORS OR COPYRIGHT HOLDERS BE LIABLE FOR ANY CLAIM, DAMAGES OR OTHER LIABILITY, WHETHER IN AN ACTION OF CONTRACT, TORT OR OTHERWISE, ARISING FROM, OUT OF OR IN CONNECTION WITH THE SOFTWARE OR THE USE OR OTHER DEALINGS IN THE SOFTWARE.

Except as contained in this notice, the name of a copyright holder shall not be used in advertising or otherwise to promote the sale, use or other dealings in this Software without prior written authorization of the copyright holder.

### **c-ares**

<http://c-ares.haxx.se>

Copyright 1998 by the Massachusetts Institute of Technology.

Permission to use, copy, modify, and distribute this software and its documentation for any purpose and without fee is hereby granted, provided that the above copyright notice appear in all copies and that both that copyright notice and this permission notice appear in supporting documentation, and that the name of M.I.T. not be used in advertising or publicity pertaining to distribution of the software without specific, written prior permission. M.I.T. makes no representations about the suitability of this software for any purpose. It is provided "as is" without express or implied warranty.

## License Information for the Software Used in the Unit

### About GPL (GNU-General Public License), LGPL (GNU Lesser General Public License) License

This product uses GPL/LGPL software and software made by other companies.

After you purchase this product, you may procure, modify or distribute the source code of the GPL/LGPL software that is used in the product.

Marantz provides the source code based on the GPL and LGPL licenses at the actual cost upon your request to our customer service center. However, note that we make no guarantees concerning the source code. Please also understand that we do not offer support for the contents of the source code.



# Dimensions

Unit : in. (mm)

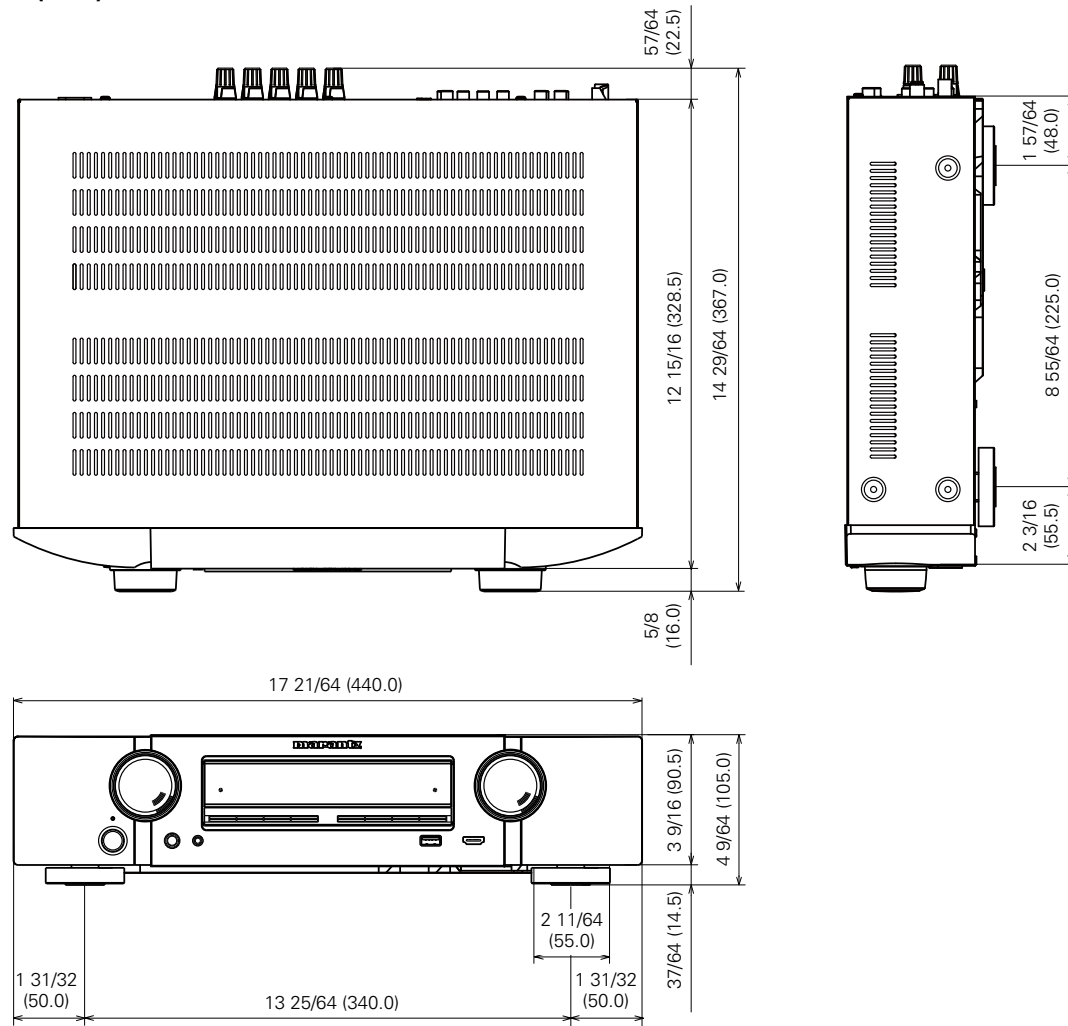

**Weight : 18 lbs 1 oz (8.2 kg)**

**[www.marantz.com](http://www.marantz.com)**

You can find your nearest authorized distributor or dealer on our website.

**marantz**<sup>®</sup> is a registered trademark.