

# marantz®

**Model PD4250D User Guide**

---

Plasma Monitor

# IMPORTANT SAFETY INSTRUCTIONS

## Read before operating equipment

1. Read these instructions.
2. Keep these instructions.
3. Heed all warnings.
4. Follow all instructions.
5. Do not use this apparatus near water.
6. Clean only with a dry cloth.
7. Do not block any of the ventilation openings. Install in accordance with the manufacturers instructions.
8. Do not install near any heat sources such as radiators, heat registers, stoves, or other apparatus (including amplifiers) that produce heat.
9. Do not defeat the safety purpose of the polarized or grounding-type plug. A polarized plug has two blades with one wider than the other. A grounding type plug has two blades and third grounding prong. The wide blade or third prong are provided for your safety. When the provided plug does not fit into your outlet, consult an electrician for replacement of the obsolete outlet.
10. Protect the power cord from being walked on or pinched particularly at plugs, convenience receptacles, and the point where they exit from the apparatus.
11. Only use attachments/accessories specified by the manufacturer.
12.  Use only with a cart, stand, tripod, bracket, or table specified by the manufacturer, or sold with the apparatus. When a cart is used, use caution when moving the cart/apparatus combination to avoid injury from tip-over.
13. Unplug this apparatus during lightning storms or when unused for long periods of time.
14. Refer all servicing to qualified service personnel. Servicing is required when the apparatus has been damaged in any way, such as power-supply cord or plug is damaged, liquid has been spilled or objects have fallen into apparatus, the apparatus has been exposed to rain or moisture, does not operate normally, or has been dropped.
15. This product may contain lead or mercury. Disposal of these materials may be regulated due to environmental considerations.  
For disposal or recycling information, please contact your local authorities or the Electronic Industries Alliance: [www.eiae.org](http://www.eiae.org).
16. **Damage Requiring Service** - The appliance should be serviced by qualified service personnel when:
  - A. The power supply cord or the plug has been damaged;  
or
  - B. Objects have fallen, or liquid has been spilled into the appliance; or
  - C. The appliance has been exposed to rain; or
  - D. The appliance does not appear to operate normally or exhibits a marked change in performance; or
  - E. The appliance has been dropped, or the enclosure damaged.
17. **Tilt/Stability** - All televisions must comply with recommended international global safety standards for tilt and stability properties of its cabinets design.
  - Do not compromise these design standards by applying excessive pull force to the front, or top, of the cabinet which could ultimately overturn the product.
  - Also, do not endanger yourself, or children, by placing electronic equipment/toys on the top of the cabinet. Such items could unsuspectingly fall from the top of the set and cause product damage and/or personal injury.
18. **Wall Mounting** - The appliance should be mounted to a wall only as recommended by the manufacturer.
19. **Power Lines** - An outdoor antenna should be located away from power lines.
20. **Outdoor Antenna Grounding** - If an outside antenna is connected to the receiver, be sure the antenna system is grounded so as to provide some protection against voltage surges and built up static charges. Section 810 of the National Electric Code, ANSI/NFPA No. 70- 1984, provides information with respect to proper grounding of the mats and supporting structure grounding of the lead-in wire to an antenna-discharge unit, size of grounding connectors, location of antenna-discharge unit, connection to grounding electrodes and requirements for the grounding electrode.
21. **Objects and Liquid Entry** - Care should be taken so that objects do not fall and liquids are not spilled into the enclosure through openings.

Apparatus shall not be exposed to dripping or splashing and that no objects filled with liquids, such as vases, shall be placed on apparatus.

### WARNING

To reduce the risk of fire or electric shock, do not expose this apparatus to rain or moisture.

# PRÉCAUTIONS IMPORTANTES DE SÉCURITÉ

## A lire avant de faire fonctionner l'appareil

1. Lire ces instructions.
2. Garder ces instructions.
3. Respecter tous les avertissements.
4. Suivre toutes les instructions.
5. Ne pas utiliser cet appareil près de l'eau.
6. Nettoyer seulement avec un chiffon sec.
7. Ne pas boucher les ouvertures d'aération. Installer selon les instructions du fabricant
8. Ne pas installer près d'une source de chaleur telle qu'un radiateur, une bouche de chauffage, une cuisinière ou d'autre matériel (y compris des amplificateurs) qui produit de la chaleur.
9. Ne pas contourner la sécurité fournie par la fiche polarisée ou la fiche de mise à la terre. Une fiche polarisée possède deux lames dont une plus large que l'autre. Une fiche de mise à la terre possède deux lames et une broche de mise à la terre. La lame large ou la broche est fournie pour votre sécurité. Lorsque la fiche fournie ne va pas dans la prise, demander à un électricien de remplacer la prise démodée.
10. Protéger le cordon d'alimentation en ne pas marcher dessous ni le coinçant, en particulier près des fiches, des prises et de l'endroit où le cordon rejoint de l'appareil.
11. N'utiliser que des accessoires préconisés par le fabricant.
12.  Utiliser seulement avec un chariot, meuble, trépied, support ou table spécifié par le fabricant ou vendu avec l'appareil. En utilisant un chariot, au moment de déplacer le chariot/téléviseur, bien faire attention pour éviter des blessures dues au renversement éventuel.
13. Débrancher cet appareil pendant des orages ou lorsqu'il ne sera pas utilisé pendant longtemps.
14. Consulter un technicien agréé de service après vente pour toute réparation. Le service après vente est nécessaire lorsque l'appareil a été endommagé de quelque façon que ce soit, telle que lorsque le cordon d'alimentation ou la fiche est endommagé, du liquide renversé, un objet tombé dans l'appareil, l'exposition de l'appareil à la pluie ou l'humidité, lorsque l'appareil ne fonctionne pas normalement ou lorsqu'on a laissé tomber l'appareil.
15. Ce produit peut contenir un plomb ou du mercure. La mise à rebut de ces matières pourrait être réglementée pour des raisons de protection de l'environnement. Pour s'informer sur la mise à rebut ou le recyclage, veuillez se mettre en contact avec les autorités locales ou l'Electronic Industries Alliance: [www.eiae.org](http://www.eiae.org).
16. **Dommages qu'il faut faire réparer** - Il faut faire réparer l'appareil par un technicien qualifié lorsque:
  - A. Le cordon d'alimentation en électricité ou la fiche a été endommagé; ou
  - B. On a laissé tomber des objets ou du liquide dans l'appareil;
  - C. On a exposé l'appareil à la pluie; ou
  - D. L'appareil ne paraît pas marcher normalement ou présente de grands changements d'opération; ou
  - E. On a laissé tomber l'appareil ou endommager le coffret.
17. Tous les téléviseurs doivent être conformes aux normes inter-nationales de sécurité préconisées pour les propriétés de stabilité et d'inclinaison dans la conception des meubles.
  - Ne pas compromettre ces normes de conception en tirant excessivement sur le devant ou le haut du meuble, ce qui risque éventuellement de renverser le produit.
  - De plus, ne pas se mettre en danger, ni mettre les enfants en danger en plaçant du matériel électronique ou des jouets sur le meuble. De tels articles pourraient tomber malencontreusement du haut du téléviseur et endommager le produit et/ou blesser des gens.
18. **Montage au mur ou au plafond** - Il faut monter l'appareil à un mur ou plafond uniquement en suivant les recommandations du fabricant.
19. **Lignes de transmission** - Il faut situer une antenne extérieure à l'écart des lignes de transmission d'électricité.
20. **Mise à terre de l'antenne extérieure** - Si une antenne extérieure est reliée au récepteur, assurez-vous que le système d'antenne est bien mis à la terre pour protéger contre les sauts de tension et l'accumulation des charges d'électricité statique.

La section 810 du National Electric Code, ANSI/NFPA No. 70-1984, fournit des renseignements sur la mise à la terre du mât et de sa structure de soutien, du fil d'entrée à un appareil de décharge/antenne, sur la grosseur des conducteurs de mise à terre, sur l'emplacement d'un appareil de décharge/antenne, sur la mise à la terre vers les électrodes de terre, ainsi que sur les recommandations sur les électrodes de terre.
21. **Entrée des objets et des liquides** - Evitez de laisser tomber des objets ou des liquides par les ouverture de l'enclos.

Ne pas exposer l'appareil aux projections ou aux écoulement d'eau et ne jamais poser un récipient contenant du liquide, un vase par exemple, sur l'appareil.

### AVERTISSEMENT

Pour réduire les risques d'incendie ou d'électrocution, ne jamais exposer cet appareil à la pluie ou à l'humidité.

# Limited Warranty for the Marantz SLIM SERIES PLASMA MONITOR

## Who is covered?

You must have proof of purchase to receive warranty service.

## What is covered?

1. Warranty coverage begins the day you purchase your Plasma Television, and continues for a period of one year.
2. Marantz America will provide in-home warranty repair.
3. Marantz America will incur all labor charges for repairs during the warranty period.
4. Marantz America will incur all freight charges for warranty repairs, both to Marantz and the return to the customer.

We suggest keeping all packing materials for any shipping that might be required.

5. All parts, including repaired and replaced parts are covered only for the original warranty period.

When the warranty on the product expires, the warranty on all replaced and repaired parts also expires.

## What is excluded?

Your warranty does not cover:

1. Labor charges for installation or setup of the product, cleaning, adjustment of customer controls on the product, and installation or repair of antenna systems outside of the product.
2. Improper installation, removal or maintenance, or failure to follow instructions supplied with the product.
3. Reception problems caused by signal conditions from cable or antenna systems outside the product.
4. Repair, attempted repair or modification performed by anyone other than an authorized Marantz America service center.
5. Any product, on which the serial number has been defaced, modified or removed.
6. Warranty is void if purchase was made from anyone other than an authorized Marantz dealer.
7. Warranty is void if purchased from outside The United States of America.
8. Warranty only valid in the United States of America.
9. Damage due to lightning or power line surges, spikes and brown outs, damages that occur during shipping or transit, or damage which is attributed to acts of God.
10. Incidental or consequential damages resulting from the product. (Some states do not allow the exclusion of incidental or consequential damages, so the above exclusion may not apply to you. This warranty gives you specific legal rights, and you may also have other rights that vary from state to state.)

11. Commercial or institutional use.

12. Any other cause which does not relate to product defect.

13. Burns or residual images upon the phosphor of the tubes.

NOTE: Pixel defect

Plasma is one of the most advanced technologies for consumer products. The panel is made by high precision technology, however some pixel defects may be found on the Plasma display panel. We are trying our best to control the quality in order to reduce the number of defective pixels. It is almost impossible to have zero pixel defects, even using the most advanced technology. This is not a problem only for Marantz, but all Plasma manufacturers. Therefore we have to note that the warranty does not cover the Plasma display panel for pixel defects. We appreciate your understanding.

## Before requesting service:

Please check your User Guide before requesting service. Adjustments of the controls and hook up guidelines discussed there may save you a service call.

## To get warranty service:

Repair must be performed by an authorized service center. If you do not know of a Marantz authorized Plasma Television service center, contact your dealer. If your dealer is an authorized service center, they will arrange for repair.

If your dealer is not a Marantz authorized Plasma Television service center, they will direct you to an authorized service center.

## Optimum performance:

For optimum performance and picture quality, the Plasma monitor is only guaranteed up to 6,230 feet above sea level.

# Important Information

## Warning

Not for use in a computer room as defined in the Standard for the Protection of Electronic Computer/ Data Processing Equipment ANSI/NFPA 75.

This equipment has been tested and found to comply with the limits for a Class B digital device, pursuant to Part 15 of the FCC Rules. These limits are designed to provide reasonable protection against harmful interference in a residential installation. This equipment generates, uses, and can radiate radio frequency energy and, if not installed and used in accordance with the instructions, may cause harmful interference to radio communications. However, there is no guarantee that interference will not occur in a particular installation. If this equipment does cause harmful interference to radio or television reception, which can be determined by turning the equipment off and on, the user is encouraged to try to correct the interference by one or more of the following measures:

- Reorient or relocate the receiving antenna.
- Increase the separation between the equipment and receiver.
- Connect the equipment into an outlet on a circuit different from that to which the receiver is connected.
- Consult the dealer or an experienced radio / TV technician for help.

## NOTE:

When you connect a computer to this monitor, use an RGB cable including the ferrite core on both ends of the cable. And regarding HDMI and power cable, attach the supplied ferrite cores. If you do not do this, this monitor will not conform to mandatory FCC standards.

Attaching the ferrite cores:

Set the ferrite cores on both ends of the HDMI cable (not supplied), and both ends of the power cable (supplied).

Close the lid tightly until the clamps click.

Use the band to fasten the ferrite core (supplied) to the HDMI cable.

HDMI cable (not supplied)



Power cable (supplied)

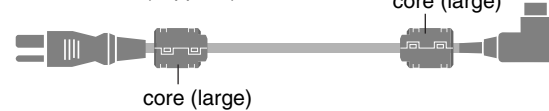

## Caution

This model is for use with the following optional accessories. Use with other optional accessories is capable of resulting in instability causing possible injury.

Manufacturer's name: Marantz Japan, Inc.

Stand: AS4250 for PD4230V, PD4250D and PD5050D

AS6150 for PD6150D

Please contact Marantz America, Inc. for approved optional accessories.

# Recommandations importantes

## Avertissement

Ne pas utiliser dans une salle d'ordinateurs telle que définie dans la Norme pour la protection des ordinateurs électroniques/appareils de traitement des données ANSI/NFPA75.

## DOC avis de conformation

Cet appareil numérique de la Classe B respecte toutes les exigences du Règlement sur le Matériel Brouilleur du Canada.

## Attention

Cet modèle est fait pour être utilisé avec les accessoires optionnels suivants. Toute utilisation avec d'autres accessoires optionnels peut entraîner une instabilité pouvant causer des blessures.

Nom du fabricant: Marantz Japan, Inc.

Support: AS4250 para PD4230U, PD4250D, y PD6150D  
AS6150 para PD6150D

Veillez contacter Marantz America, Inc. pour connaître les accessoires optionnels approuvés.

### REMARQUE:

Pour raccorder un ordinateur à ce moniteur, procéder à l'aide d'un câble RGB à âme de ferrite aux deux extrémités. Sur les câbles HDMI et les câbles d'alimentation électrique, fixer les âmes de ferrite fournies aux extrémités. Si vous ne le faites, le moniteur ne sera pas en conformité avec les exigences des standards FCC.

Fixation des noyaux en ferrite.

Monter les tores en ferrite aux deux extrémités du câble HDMI (non fourni) et aux deux extrémités du câble d'alimentation électrique (fourni).

Fermez doucement le couvercle jusqu'à ce que les crans se clipsent.

Fixer le tore en ferrite (fourni) au câble HDMI à l'aide d'un collier.

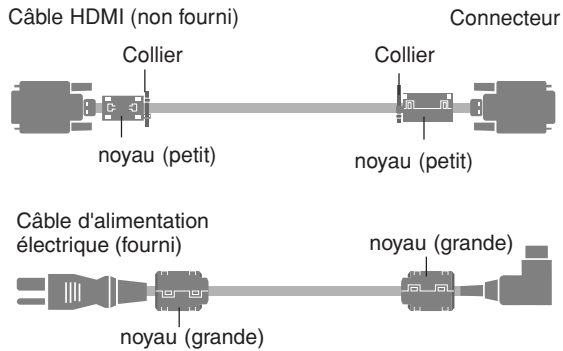

# Important Information

## Precautions

Please read this User Guide carefully before using your plasma monitor and keep the User Guide handy for future reference.

**CAUTION**



**RISK OF ELECTRIC SHOCK  
DO NOT OPEN**



**CAUTION: TO REDUCE THE RISK OF ELECTRIC SHOCK, DO NOT REMOVE COVER. NO USER-SERVICEABLE PARTS INSIDE. REFER SERVICING TO QUALIFIED SERVICE PERSONNEL.**

 This symbol warns the user that uninsulated voltage within the unit may have sufficient magnitude to cause electric shock. Therefore, it is dangerous to make any kind of contact with any part inside of this unit.

 This symbol alerts the user that important literature concerning the operation and maintenance of this unit has been included. Therefore, it should be read carefully in order to avoid any problems.

**WARNING**

TO PREVENT FIRE OR SHOCK HAZARDS, DO NOT EXPOSE THIS UNIT TO RAIN OR MOISTURE. ALSO DO NOT USE THIS UNIT'S POLARIZED PLUG WITH AN EXTENSION CORD RECEPTACLE OR OTHER OUTLETS, UNLESS THE PRONGS CAN BE FULLY INSERTED. REFRAIN FROM OPENING THE CABINET AS THERE ARE HIGH-VOLTAGE COMPONENTS INSIDE. REFER SERVICING TO QUALIFIED SERVICE PERSONNEL.

## Warnings and Safety Precaution

This plasma monitor is designed and manufactured to provide long, trouble-free service. No maintenance other than cleaning is required. Please see the section "Plasma monitor cleaning procedure" on the next page.

The plasma display panel consists of fine picture elements (cells) with more than 99.99 percent active cells. There may be some cells that do not produce light or remain lit.

For operating safety and to avoid damage to the unit, read carefully and observe the following instructions. To avoid shock and fire hazards:

1. Provide adequate space for ventilation to avoid internal heat build-up. Do not cover rear vents or install the unit in a closed cabinet or shelves.

If you install the unit in an enclosure, make sure there is adequate space at the top of the unit to allow hot air to rise and escape. If the monitor becomes too hot, the overheat protector will be activated and the monitor will be turned off. If this happens, turn off the power to the monitor and unplug the power cord. If the room where the monitor is installed is particularly hot, move the monitor to a cooler location, and wait for 60 minutes to cool the monitor. If the problem persists, contact your dealer for service.

2. Do not use this unit's polarized plug with extension cords or outlets unless the prongs can be completely inserted.
3. Do not expose the unit to water or moisture.
4. Avoid damage to the power cord, and do not attempt to modify the power cord.
5. Unplug the power cord during electrical storms or if the unit will not be used over a long period.
6. Do not open the cabinet which has potentially dangerous high voltage components inside. If the unit is damaged in this way the warranty will be void. Moreover, there is a serious risk of electric shock.
7. Do not attempt to service or repair the unit. The manufacturer is not liable for any bodily harm or damage caused if unqualified persons attempt service or open the back cover. Refer all service to authorized Service Centers.

To avoid damage and prolong operating life:

1. Use only with 100-240V 50/60Hz AC power supply. Continued operation at line voltages greater than 100-240 Volts AC will shorten the life of the unit, and might even cause a fire hazard.
2. Handle the unit carefully when installing it and do not drop.
3. Set the unit away from heat, excessive dust, and direct sunlight.
4. Protect the inside of the unit from liquids and small metal objects. In case of accident, unplug the power cord and have it serviced by an authorized Service Center.
5. Do not hit or scratch the panel surface as this causes flaws on the surface of the screen.
6. For correct installation and mounting it is strongly recommended to use a trained, authorized dealer.
7. As is the case with any phosphor-based display (like a CRT monitor, for example) light output will gradually decrease over the life of a Plasma Display Panel.
8. To avoid sulfurization it is strongly recommended not to place the unit in a dressing room in a public bath or hot spring bath.
9. Do not use in a moving vehicle, as the unit could drop or topple over and cause injuries.
10. Do not place the unit on its side, upside-down or with the screen facing up or down, to avoid combustion or electric shock.

Plasma monitor cleaning procedure:

1. Use a soft dry cloth to clean the front panel and bezel area. Never use solvents such as alcohol or thinner to clean these surfaces.
2. Clean plasma ventilation areas with a vacuum cleaner with a soft brush nozzle attachment.
3. To ensure proper ventilation, cleaning of the ventilation areas must be carried out monthly. More frequent cleaning may be necessary depending on the environment in which the plasma monitor is installed.

Recommendations to avoid or minimize phosphor burn-in: Like all phosphor-based display devices and all other gas plasma displays, plasma monitors can be susceptible to phosphor burn under certain circumstances. Certain operating conditions, such as the continuous display of a static image over a prolonged period of time, can result in phosphor burn if proper precautions are not taken. To protect your investment in this plasma monitor, please adhere to the following guidelines and recommendations for minimizing the occurrence of image burn:

- \* Always enable and use your computer's screen saver function during use with a computer input source.
- \* Display a moving image whenever possible.
- \* Change the position of the menu display from time to time.
- \* Always power down the monitor when you are finished using it.

If the plasma monitor is in long term use or continuous operation take the following measures to reduce the likelihood of phosphor burn:

- \* Lower the Brightness and Contrast levels as much as possible without impairing image readability.

- \* Display an image with many colors and color gradations (i.e. photographic or photo-realistic images).
- \* Create image content with minimal contrast between light and dark areas, for example white characters on black backgrounds. Use complementary or pastel color whenever possible.
- \* Avoid displaying images with few colors and distinct, sharply defined borders between colors.

**\* Note:** Burn-in is not covered by the warranty.

Contact your dealer for other recommended procedures that will best suit your particular application needs.

## Recommandations importantes

### Précautions

Veillez lire avec attention ce manuel avant d'utiliser le moniteur à plasma et le conserver accessible pour s'y référer ultérieurement.

**ATTENTION**



**RISQUE D'ELECTROCUTION  
NE PAS OUVRIR**



**MISE EN GARDE:** AFIN DE REDUIRE LES RISQUES D'ELECTRO-CUTION, NE PAS DEPOSER LE COUVERCLE, IL N'Y A AUCUNE PIECE UTILISABLE A L'INTERIEUR DE CET APPAREIL. NE CONFIER LES TRAVAUX D'ENTRETIEN QU'A UN PERSONNEL QUALIFIE.

Ce symbole a pour but de prévenir l'utilisateur de la présence d'une tension dangereuse, non isolée se trouvant à l'intérieur de l'appareil. Elle est d'une intensité suffisante pour constituer un risque d'électrocution. Eviter le contact avec les pièces à l'intérieur de cet appareil.

Ce symbole a pour but de prévenir l'utilisateur de la présence d'importantes instructions concernant l'entretien et le fonctionnement de cet appareil. Par conséquent, elles doivent être lues attentivement afin d'éviter des problèmes.

**AVERTISSEMENT**

AFIN DE REDUIRE LES RISQUES D'INCENDIE OU D'ELECTROCUTION, NE PAS EXPOSER CET APPAREIL A LA PLUIE OU A L'HUMIDITE. AUSSI, NE PAS UTILISER LA FICHE POLARISEE AVEC UN PROLONGATEUR OU UNE AUTRE PRISE DE COURANT SAUF SI CES LAMES PEUVENT ETRE INSEREES A FOND. NE PAS OUVRIR LE COFFRET, DES COMPOSANTS HAUTE TENSION SE TROUVENT A L'INTERIEUR. LAISSERA UN PERSONNEL QUALIFIE LE SOIN DE REPARER CET APPAREIL.

### Mises en garde et précautions de sécurité

Ce moniteur à plasma a été conçu et fabriqué pour une utilisation fiable et durable. Il ne nécessite aucun entretien en dehors du nettoyage. Voir la section "Méthode de nettoyage du moniteur à plasma" plus loin. Le panneau à affichage plasma est constitué de fines particules d'images (cellules) dont plus de 99,99% sont actives. Certaines d'entre elles ne produisent pas de lumière ou restent allumées.

Pour des raisons de sécurité et pour éviter d'endommager l'appareil, lire attentivement les instructions suivantes.

Pour éviter les risques d'électrocution et d'incendie:

1. Laisser suffisamment d'espace autour de l'appareil pour la ventilation et éviter toute augmentation excessive de la température interne. Ne pas couvrir les événements ou l'installer dans un endroit trop exigü.
- Si vous installez l'appareil dans un espace clos, assurez-vous qu'il y ait suffisamment d'espace au dessus pour permettre à l'air chaud de s'élever et de s'évacuer. Si la température du moniteur devient excessive, la protection contre les surchauffes entrera en action et coupera l'alimentation. Dans ce cas, éteindre l'appareil et débrancher le câble d'alimentation. Si la température de la pièce dans laquelle se trouve le moniteur est particulièrement élevée, déplacer celui-ci dans un endroit plus frais et attendre environ 60 minutes qu'il refroidisse. Si le problème persiste, prendre contact avec votre revendeur.
2. Ne pas raccorder la prise d'alimentation polarisée de ce périphérique à une rallonge ou une prise murale si les fiches ne peuvent pas être complètement insérées.
3. Ne pas exposer à l'eau ou à l'humidité.
4. Eviter d'endommager le cordon d'alimentation, et ne pas modifier le cordon d'alimentation.
5. Débrancher le câble d'alimentation électrique pendant les orages ou les longues périodes d'inactivité.
6. Ne pas ouvrir le coffret. Des composants de haute tension se trouvent à l'intérieur. Si l'appareil est endommagé de cette manière, la garantie devient caduque. De plus, il y a risque d'électrocution.



7. Ne pas essayer d'intervenir ou de réparer l'appareil. Le fabricant décline toute responsabilité en cas de blessure corporelle ou de dégâts matériels résultant d'une opération d'entretien quelconque effectuée par des personnes non qualifiées ou résultant de l'ouverture du couvercle arrière. S'adresser aux services après-vente autorisés.

Pour éviter des dommages et prolonger la durée de service de l'appareil:

1. N'utiliser qu'une source d'alimentation de 100-240 V 50/60 Hz CA. Le fait d'utiliser l'appareil en continu à des tensions de ligne supérieures à 100-240 Volts CA réduit sa durée de vie et risque de provoquer un incendie.
2. Manipuler l'appareil avec soin pendant son déplacement et ne pas le faire tomber.
3. Eloigner l'appareil des endroits chauds, très poussiéreux et exposés en plein soleil.
4. Éviter que des liquides et des petits objets métalliques pénètrent à l'intérieur de l'appareil. En cas d'incident de ce genre, débrancher le câble d'alimentation électrique et confier le moniteur à un service après-vente agréé.
5. Ne pas frapper ou rayer la surface de la écran plasma, car des défauts risquent de se produire sur la surface de la écran plasma.
6. Pour un montage et une installation correcte, il est fortement recommandé de faire appel à un revendeur agréé et qualifié.
7. Comme c'est le cas pour tout affichage à base de phosphore (comme un moniteur CRT, par exemple), la puissance de lumière baisse graduellement au cours de la vie du Panneau d'Affichage à Plasma.
8. Pour éviter tout risque de sulfuration, il est fortement conseillé de ne pas installer l'appareil dans un vestiaire, un bain public ou un bain de source thermale.
9. Ne pas utiliser dans un véhicule en marche car l'unité pourrait tomber ou glisser et provoquer des blessures.
10. Pour éviter l'inflammation ou les chocs électriques, ne pas placer l'unité sur la tranche, à l'envers ou avec l'écran vers le bas ou vers le haut.

Méthode de nettoyage du moniteur à plasma:

1. Nettoyer le panneau avant et le cadre en procédant à l'aide d'un chiffon doux et sec. Ne jamais utiliser de solvants du type alcool ou diluant pour le nettoyage de ces surfaces.
2. Nettoyer les prises d'aération du plasma en procédant à l'aide d'une brosse à poils doux fixée à un aspirateur.
3. Pour garantir la bonne ventilation du moniteur, nettoyer les prises d'air tous les mois. Un nettoyage plus fréquent peut s'avérer nécessaire selon les conditions environnantes dans lesquelles le moniteur à plasma est utilisé.

Pour éviter les risques de brûlage du luminophore, les mesures suivantes sont recommandées:

Comme tous les périphériques d'affichage à base luminophore et tous les autres affichages gaz plasma, les moniteurs plasma peuvent être sujets au brûlage du luminophore dans certaines circonstances. Certaines conditions d'utilisation, telles que l'affichage continu d'une image statique pour une durée prolongée, peuvent causer le brûlage du luminophore si aucune précaution n'est prise. Pour protéger votre investissement dans ce moniteur à plasma, veuillez suivre les directives et les conseils suivantes pour minimiser l'occurrence le marquage de l'écran:

- Assurez-vous de mettre en marche et d'utiliser l'économisateur d'écran chaque fois que c'est possible lorsque vous l'utilisez avec une source d'entrée d'ordinateur.
- Affichez une image en mouvement aussi souvent que possible.
- Changez la position de l'affichage de menu de temps à autre.
- Coupez toujours l'alimentation lorsque vous avez terminé d'utiliser le moniteur.

Si le moniteur est en usage continu ou longue durée, prenez les mesures suivantes afin d'éviter l'occurrence le brûlage du luminophore:

- Abaissez le niveau de l'image (contraste, luminosité) autant que possible, sans faire perdre la lisibilité de l'image.
- Affichez une image avec de nombreuses couleurs et graduations de couleur (par ex. des images photographiques ou photo-réalistes).
- Créez un contenu d'image avec un contraste minimal entre les zones sombres et les zones claires, par exemple, des caractères blancs sur un fond noir. Utilisez des couleurs complémentaires ou pastels le plus souvent possible.
- Évitez d'afficher des images avec peu de couleurs et des limites nettes et clairement définies entre les couleurs.

\* **Remarque:** Le brûlage de l'écran n'est pas couvert par la garantie.

Contactez un revendeur agréé ou un revendeur de marque pour d'autres procédures qui conviendront le mieux à vos besoins particuliers.

# Contents

<b>Installation</b> .....	<b>10</b>
Ventilation Requirements for enclosure mounting .....	10
How to use the safety metal fittings and the screws for safety metal fittings .....	10
Cable Management .....	11
How to use the remote control .....	11
Battery Installation and Replacement .....	11
Operating Range .....	11
Handling the remote control .....	11
<b>Part Names and Function</b> .....	<b>12</b>
Front View .....	12
Rear View/ Terminal Board .....	13
Remote Control .....	14
<b>Basic Operations</b> .....	<b>15</b>
POWER .....	15
To turn the unit ON and OFF: .....	15
VOLUME .....	15
To adjust the sound volume: .....	15
MUTE .....	15
To mute the audio: .....	15
DISPLAY .....	15
To check the settings: .....	15
DIGITAL ZOOM .....	15
OFF TIMER .....	15
To set the off timer: .....	15
To check the remaining time: .....	15
To cancel the off timer: .....	15
<b>WIDE Operations</b> .....	<b>16</b>
Wide Screen Operation (manual) .....	16
When viewing videos or digital video discs .....	16
Wide Screen Operation with Computer Signals .....	17
<b>OSM (On Screen Menu) Controls</b> .....	<b>18</b>
Menu Operations .....	18
Menu Tree .....	19
Picture Settings Menu .....	21
Storing picture settings .....	21
Adjusting the picture .....	21
Reducing noise in the picture .....	21
Setting the color temperature .....	22
Adjusting the color to the desired level .....	22
Changing the Gamma Curve .....	22
Making the Low Tone adjustments .....	22
Adjusting the pedestal level (black level) .....	23
Adjusting the colors .....	23
Setting the picture to suit the movie .....	23
Setting the picture mode according to the brightness of the room .....	23
Audio Settings Menu .....	24
Adjusting the treble, bass and left/right balance and audio input select .....	24
Setting the allocation of the audio connectors .....	24
Image Adjust Settings Menu .....	24
Adjusting the Position, Size, Fine Picture, Picture ADJ. ...	24
SET UP Settings Menu .....	25
Setting the language for the menus .....	25
Setting the BNC connectors .....	25
Checking the signal being transmitted to RGB1 terminal .....	25
Setting high definition images to the suitable screen size .....	25
Setting a computer image to the correct RGB select screen .....	25
Setting the signal and black level for HDMI signal ....	26
Setting the video signal format .....	26
Setting the background color when no signal is being input .....	26
Setting the gray level for the sides of the screen .....	27
Setting the screen size for S1/S2 video input .....	27
Turning on/off the menu display .....	27

Setting the position of the menu .....	27
Resetting to the default values .....	27
Function Settings Menu .....	28
Setting the power management for computer images ...	28
POWER/STANDBY indicator .....	28
Setting the Input Skip .....	28
Reducing burn-in of the screen .....	28
Setting Closed Caption .....	30
Reducing the brightness of Closed Caption .....	30
Signal Information Menu .....	30
Checking the frequencies, polarities of input signals, and resolution .....	30

<b>External Control</b> .....	<b>31</b>
Application .....	31
Connections .....	31
Type of connector: D-Sub 9-pin male .....	31
Communication Parameters .....	31
External Control Codes (Reference) .....	31

<b>Pin Assignments</b> .....	<b>31</b>
mini D-Sub 15-pin connector (Analog) .....	31
HDMI connector (Digital) .....	31

<b>Troubleshooting</b> .....	<b>32</b>
------------------------------	-----------

<b>Specifications : PD4230V</b> .....	<b>33</b>
---------------------------------------	-----------

<b>Specifications : PD4250D</b> .....	<b>34</b>
---------------------------------------	-----------

<b>Specifications : PD5050D</b> .....	<b>35</b>
---------------------------------------	-----------

<b>Specifications : PD6150D</b> .....	<b>36</b>
---------------------------------------	-----------

<b>Table of Signals Supported</b> .....	<b>37</b>
---	-----------

■ PD4230V Supported resolution .....	37
Computer input signals supported by this system .....	37

<b>Table of Signals Supported</b> .....	<b>38</b>
---	-----------

■ PD4250D Supported resolution .....	38
Computer input signals supported by this system .....	38

<b>Table of Signals Supported</b> .....	<b>39</b>
---	-----------

■ PD5050D/PD6150D Supported resolution .....	39
Computer input signals supported by this system .....	39

## Contents of the Package

- Plasma monitor
- Power cord
- Remote control with two AAA Batteries
- User Guide
- Safety metal fittings
- Ferrite cores, bands
- Cable clamps

\* These are fittings for fastening the unit to a wall to prevent tipping due to external shock when using the stand (optional). Fasten the safety fittings to the holes in the back of the monitor using the safety fitting mount screws (see page 10).

## Options

- Wall mount unit
- Ceiling mount unit
- Tilt mount unit
- Stand

# Installation

You can attach your optional mounts or stand to the plasma monitor in one of the following two ways:

- \* While it is upright. (See Drawing A)
- \* As it is laid down with the screen face down (See Drawing B). Lay the protective sheet, which was wrapped around the monitor when it was packaged, beneath the screen surface so as not to scratch the screen face.
- \* Do not touch or hold the screen face when carrying the unit.

• **This device cannot be installed on its own. Be sure to use a stand or original mounting unit. (Wall mount unit, Stand, etc.)**

\* See page 9.

• **For correct installation and mounting it is strongly recommended to use a trained, authorized dealer.**

**Failure to follow correct mounting procedures could result in damage to the equipment or injury to the installer.**

**Product warranty does not cover damage caused by improper installation.**

\* **Use only the mounting kit or stand provided by manufacturer and listed under Options.**

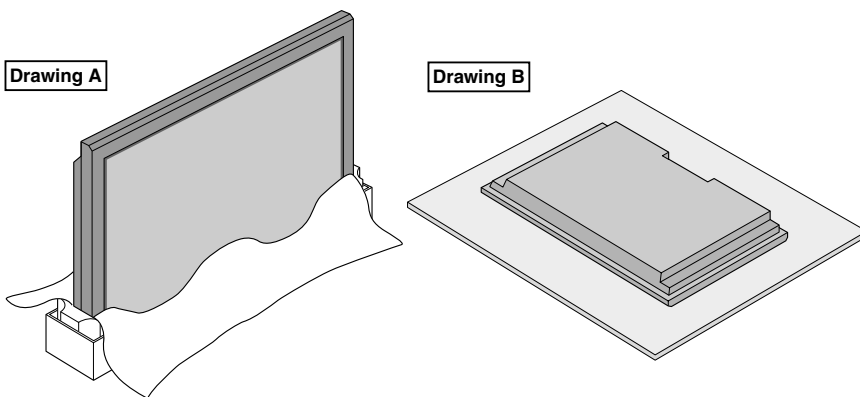

## Ventilation Requirements for enclosure mounting

To allow heat to disperse, leave space between surrounding objects as shown on the diagram below when installing.

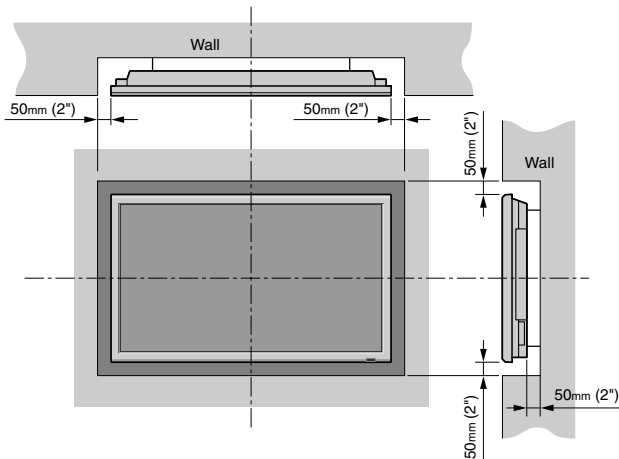

## How to use the safety metal fittings and the screws for safety metal fittings

These are fittings for fastening the unit to a wall to prevent tipping due to external shock when using the stand (optional). Fasten the safety fittings to the holes in the back of the monitor using the safety fitting mount screws.

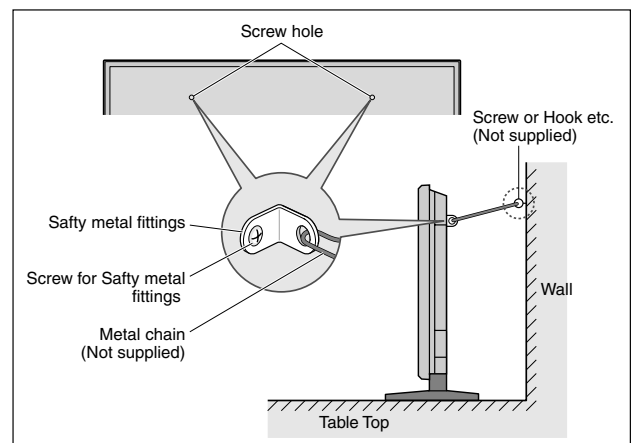

## Cable Management

Using the cable clamps provided with the plasma display, bundle at the back of the unit the signal and audio cables connected to the display.

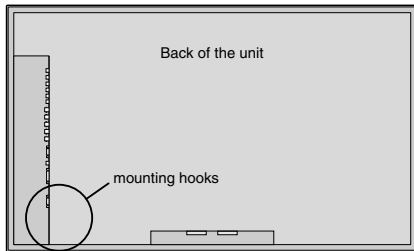

To attach

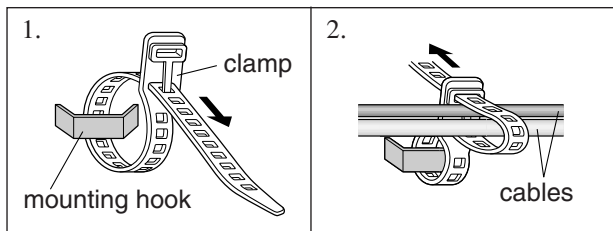

To detach

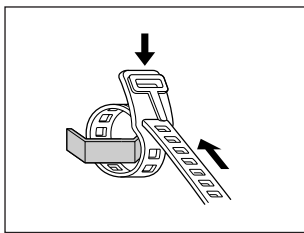

## How to use the remote control

### Battery Installation and Replacement

Insert the 2 "AAA" batteries, making sure to set them in with the proper polarity.

1. Press and open the cover.

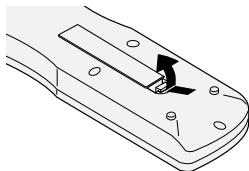

2. Align the batteries according to the (+) and (-) indication inside the case.

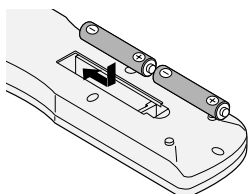

3. Replace the cover.

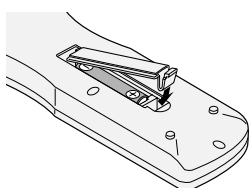

## Operating Range

- \* Use the remote control within a distance of about 7 m/ 23ft. from the front of the monitor's remote control sensor and at horizontal and vertical angles of up to approximately 30°.
- \* The remote control operation may not function if the monitor's remote control sensor is exposed to direct sunlight or strong artificial light, or if there is an obstacle between the sensor and the remote control.

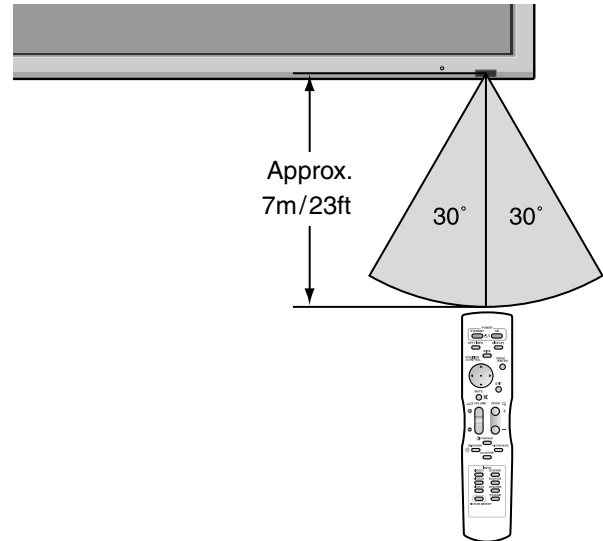

## Handling the remote control

- Do not drop or mishandle the remote control.
- Do not get the remote control wet. If the remote control gets wet, wipe it dry immediately.
- Avoid heat and humidity.
- When not using the remote control for a long period, remove the batteries.
- Do not use new and old batteries together, or use different types together.
- Do not take apart the batteries, heat them, or throw them into a fire.

# Part Names and Function

## Front View

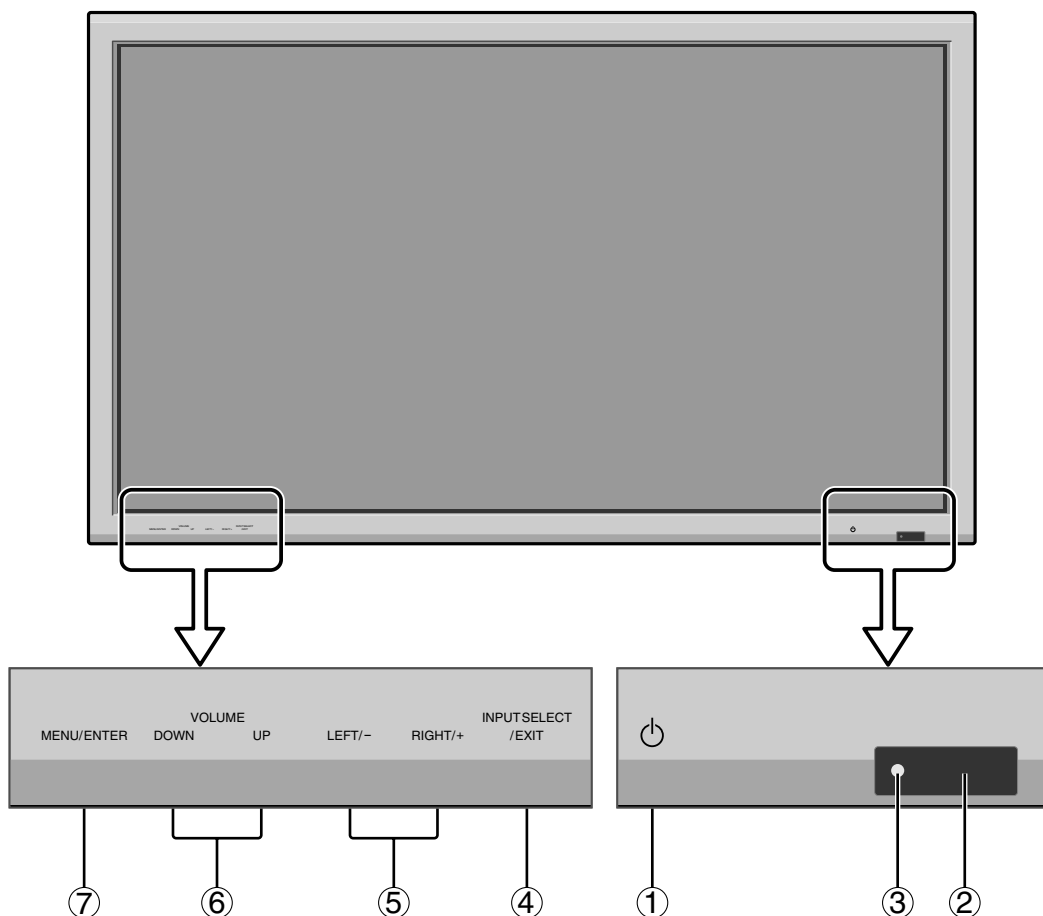

**① Power**

Turns the monitor's power on and off.

**② Remote sensor window**

Receives the signals from the remote control.

**③ POWER/STANDBY indicator**

When the power is on ..... Lights green.  
When the power is in the standby mode ... Lights red.

**④ INPUT SELECT / EXIT**

Switches the input.  
The available inputs depend on the setting of "BNC INPUT", "RGB SELECT" and "HDMI SET UP".  
Functions as the EXIT buttons in the On-Screen Menu (OSM) mode.

**⑤ LEFT/- and RIGHT/+**

Enlarges or reduces the image. Functions as the CURSOR (◀/▶) buttons in the On-Screen Menu (OSM) mode.

**⑥ VOLUME DOWN and UP**

Adjusts the volume. Functions as the CURSOR (▲/▼) buttons in the On-Screen Menu (OSM) mode.

**⑦ MENU/ENTER**

Sets the On-Screen Menu (OSM) mode and displays the main menu.

**WARNING**

The Power on/off switch does not disconnect the plasma display completely from the supply mains.

## Rear View/ Terminal Board

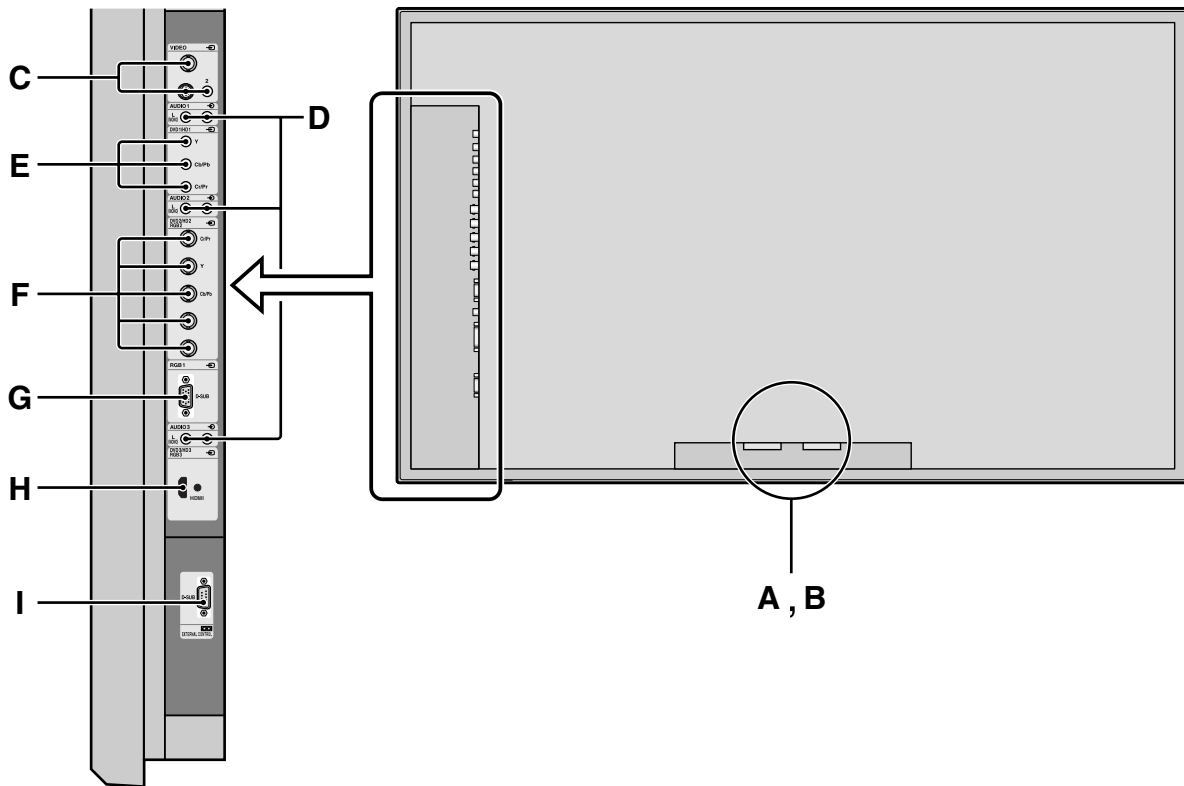

### A AC IN

Connect the included power cord here.

### B EXT SPEAKER L and R

Connect speakers (optional) here. Maintain the correct polarity. Connect the  $\oplus$  (positive) speaker wire to the  $\oplus$  EXT SPEAKER terminal and the  $\ominus$  (negative) speaker wire to the  $\ominus$  EXT SPEAKER terminal on both LEFT and RIGHT channels.

Please refer to your speaker's User Guide.

### C VIDEO1, 2, 3 (BNC, RCA, S-Video)

Connect VCR's, DVD's or Video Cameras, etc. here.

### D AUDIO1, AUDIO2, AUDIO3

These are audio input terminals.

The input is selectable. Set which video image to allot them from the audio menu screen.

### E DVD1 / HD1

Connect DVD's, High Definition or Laser Discs, etc. here.

### F DVD2/ HD2, RGB2

DVD2/ HD2: You can connect DVDs, High Definition sources, Laser Discs, etc. here.

This input can be set for use with an RGB or component source.

(see page 25)

RGB2: You can connect an analog RGB signal and the synchronization signal.

### G RGB1 (D-Sub)

Connect an analog RGB signal from a computer, etc. here.

### H DVD3/HD3, RGB3 (HDMI)

Connect a digital signal (TMDS) from a source with a HDMI output.

This input can be set for use with an RGB3 or DVD3/ HD3 source. (see page 26)

### I EXTERNAL CONTROL (D-Sub)

This terminal is used when operating and controlling the monitor externally (by external control).

## Remote Control

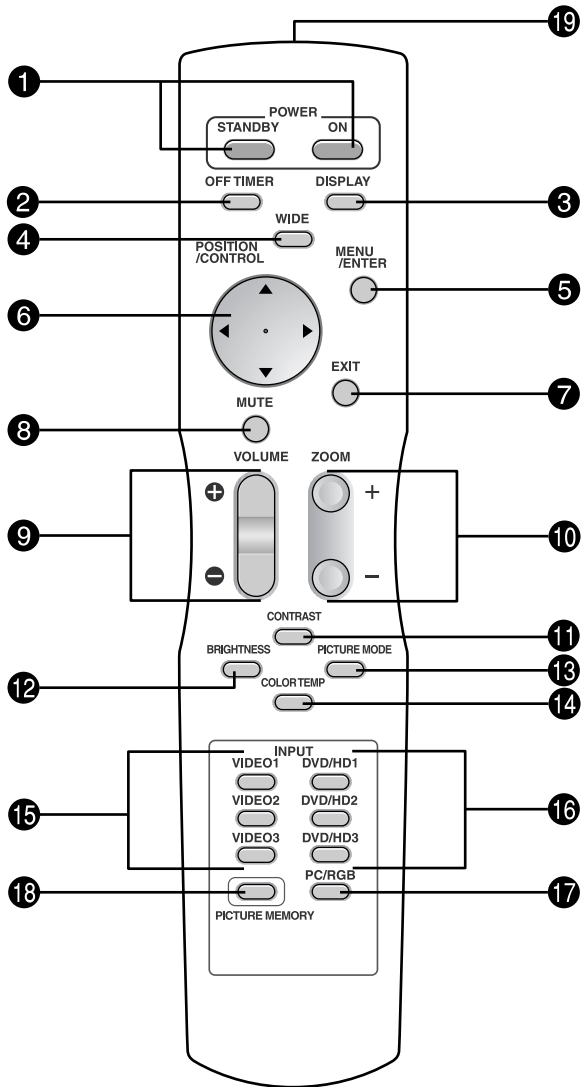

- ⑧ **MUTE**  
Mutes the audio.
- ⑨ **VOLUME (+ /-)**  
Adjusts the audio volume.
- ⑩ **ZOOM (+ /-)**  
Enlarges or reduces the image.
- ⑪ **CONTRAST**  
Press this button to adjust contrast directly.
- ⑫ **BRIGHTNESS**  
Press this button to adjust brightness directly.
- ⑬ **PICTURE MODE**  
Press this button to adjust picture mode directly.
- ⑭ **COLOR TEMP**  
Press this button to adjust color tone directly.
- ⑮ **VIDEO1, 2, 3**  
Press this button to select VIDEO as the source. VIDEO can also be selected using the INPUT SELECT button on the monitor.
- ⑯ **DVD/HD1, 2, 3**  
Press this button to select DVD/HD as the source. DVD/HD can also be selected using the INPUT SELECT button on the monitor.
- ⑰ **PC/RGB**  
Press this button to select PC/RGB as the source. PC/RGB can also be selected using the INPUT SELECT button on the monitor.
- ⑱ **PICTURE MEMORY**  
Switches sequentially between picture memory settings 1 to 6.
- ⑲ **Remote control signal transmitter**  
Transmits the remote control signals.

- ① **POWER ON/STANDBY**  
Switches the power on/standby.  
(This does not operate when POWER/STANDBY indicator of the main unit is off.)
- ② **OFF TIMER**  
Activates the off timer for the unit.
- ③ **DISPLAY**  
Displays the source settings on the screen.
- ④ **WIDE**  
Automatically detects the signal and sets the aspect ratio.  
Wide button is not active for all signals.
- ⑤ **MENU/ENTER**  
Press this button to access the OSM controls.  
Press this button during the display of the main menu to go to the sub menu.
- ⑥ **CURSOR (▲ / ▼ / ◀ / ▶)**  
Use these buttons to select items or settings and to adjust settings or switch the display patterns.
- ⑦ **EXIT**  
Press this button to exit the OSM controls in the main menu. Press this button during the display of the sub menu to return to the previous menu.

# Basic Operations

## POWER

### To turn the unit ON and OFF:

1. Plug the power cord into an active AC power outlet.
2. Press the Power button (on the unit).  
The monitor's POWER/STANDBY indicator turns red and the standby mode is set.
3. Press the POWER ON button (on the remote control) to turn on the unit.  
The monitor's POWER/STANDBY indicator will light up (green) when the unit is on.
4. Press the POWER STANDBY button (on the remote control) or the Power button (on the unit) to turn off the unit.  
The monitor's POWER/STANDBY indicator turns red and the standby mode is set (only when turning off the unit with the remote control).

## VOLUME

### To adjust the sound volume:

1. Press and hold the VOLUME ⊕ button (on the remote control or the unit) to increase to the desired level.
2. Press and hold the VOLUME ⊖ button (on the remote control or the unit) to decrease to the desired level.

## MUTE

### To mute the audio:

Press the MUTE button on the remote control to mute the audio; press again to restore.

## DISPLAY

### To check the settings:

1. The screen changes each time the DISPLAY button is pressed.
2. If the button is not pressed for approximately three seconds, the menu turns off.

## DIGITAL ZOOM

Digital zoom specifies the picture position and enlarges the picture.

1. Press the ZOOM (+ or -) button to display magnifying glass. (🔍)

### To change the size of the picture:

Press the ZOOM+ button and enlarge the picture.  
A press of the ZOOM- button will reduce the picture and return it to its original size.

### To change the picture position:

Select the position with the ▲▼◀▶ buttons.

2. Press the EXIT button to delete the pointer.

## OFF TIMER

### To set the off timer:

The off timer can be set to turn the power off after 30, 60, 90 or 120 minutes.

1. Press the OFF TIMER button to start the timer at 30 minutes.
2. Press the OFF TIMER button to the desired time.
3. The timer starts when the menu turns off.

→ 30 → 60 → 90 → 120 → 0

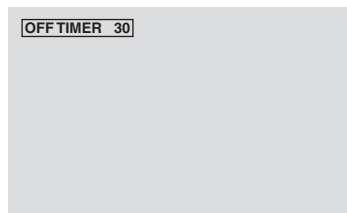

### To check the remaining time:

1. Once the off timer has been set, press the OFF TIMER button once.
2. The remaining time is displayed, then turns off after a few seconds.
3. When five minutes remain the remaining time appears until it reaches zero.

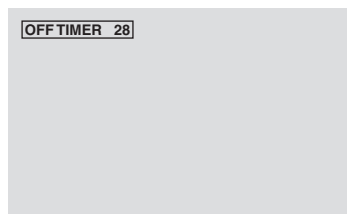

### To cancel the off timer:

1. Press the OFF TIMER button twice in a row.
2. The off timer is canceled.



### Note:

After the power is turned off with the off timer ...  
A slight current is still supplied to the monitor. When you are leaving the room or do not plan to use the system for a long period of time, turn off the power of the monitor.



# WIDE Operations

## Wide Screen Operation (manual)

With this function, you can select one of six screen sizes.

### When viewing videos or digital video discs

1. Press the WIDE button on the remote control.
2. Within 3 seconds ...

Press the WIDE button again.

The screen size switches as follows:

→ NORMAL → ANAMORPHIC → STADIUM → ZOOM → 2.35:1 → 14:9

When a 720P or 1080I signal is input:

ANAMORPHIC ↔ 2.35:1

### NORMAL size screen (4:3)

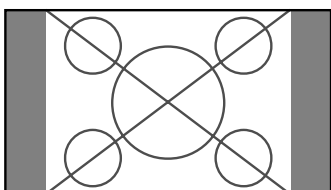

The normal size screen is displayed.

- \* The picture has the same size as video pictures with a 4 : 3 aspect ratio.

### ANAMORPHIC size screen

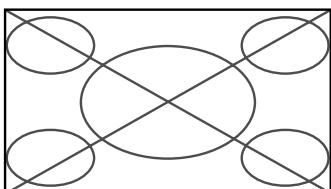

The image is expanded in the horizontal direction.

- \* Images compressed in the horizontal direction ("squeezed images") are expanded in the horizontal direction and displayed on the entire screen with correct linearity. (Normal images are expanded in the horizontal direction.)

### STADIUM size screen

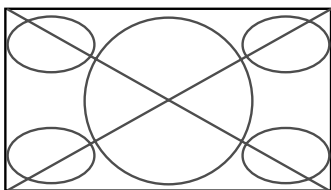

The picture is expanded in the horizontal and vertical directions at different ratios.

- \* Use this for watching normal video programs (4:3) with a wide screen.

### ZOOM size screen

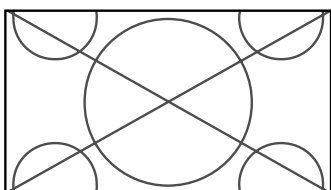

The picture is expanded in the horizontal and vertical direction, maintaining the original proportions.

- \* Use this for theater size (wide) movies, etc.

### 2.35:1 size screen

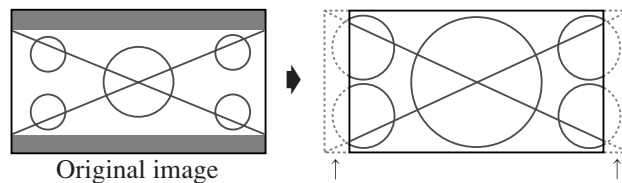

The squeezed film image is expanded to fulfill the entire screen at a ratio of 2.35:1. Black bands do not appear at the top and bottom but information is lost on the left and right margins.

- This feature is available when the input signal is video, component (480I, 480P, 576I, 576P, 720P, 1080I) or RGB (525P or 625P signal from a scan converter).
- \* If black bands appear on the top and bottom in the full size screen, select the 2.35:1 size screen to avoid phosphor burn-in.

### 14:9 size screen

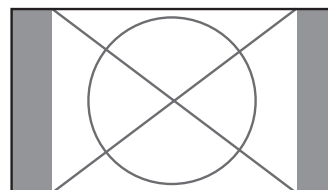

The image is displayed at a 14:9 aspect ratio.

- \* This feature is available when the input signal is video, component (480I, 480P, 576I, 576P) or RGB (525P or 625P signal from a scan converter).

### Note:

Do not allow the displayed in 4:3 mode for an extended period. This can cause a phosphor burn-in.

## Wide Screen Operation with Computer Signals

Switch to the wide screen mode to expand the 4 : 3 image to fill the entire screen.

1. Press the WIDE button on the remote control.
2. Within 3 seconds ...

Press the WIDE button again.

The screen size switches as follows:

→ **NORMAL** → **ANAMORPHIC** → **ZOOM** →

**NORMAL** size screen (4:3 or SXGA 5:4)

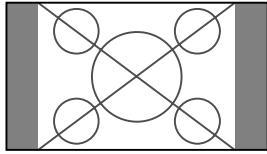

The picture has the same size as the normal computer image.

**ANAMORPHIC** size screen

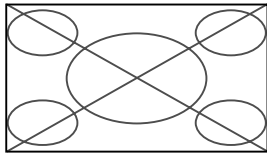

The image is expanded in the horizontal direction.

**ZOOM** size screen

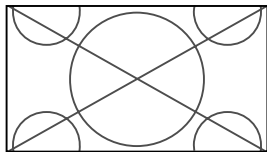

When wide signals are input.

**ANAMORPHIC** size screen

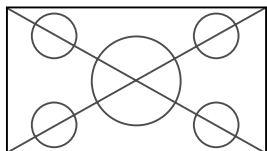

### Information

#### ■ Supported resolution

See page 37-39 for details on the display output of the various VESA signal standards supported by the monitor.

■ **When 852 (848) dot × 480 line wide VGA\* signals with a vertical frequency of 60 Hz and horizontal frequency of 31.7 (31.0) kHz are input**

Select an appropriate setting for RGB SELECT mode referring to the “Table of Signals Supported” on page 37-39.

\* “VGA”, “SVGA” and “SXGA” are registered trademarks of IBM, Inc. of the United States.

#### **Note:**

Do not allow the displayed in 4:3 mode for an extended period. This can cause a phosphor burn-in.

# OSM (On Screen Menu) Controls

## Menu Operations

The following describes how to use the menus and the selected items.

1. Press the MENU/ENTER button on the remote control to display the MAIN MENU.

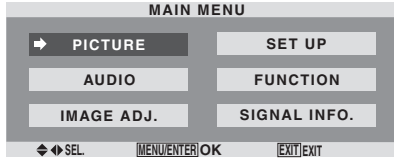

2. Press the cursor buttons ▲ ▼ on the remote control to highlight the menu you wish to enter.
3. Press the MENU/ENTER button on the remote control to select a sub menu or item.

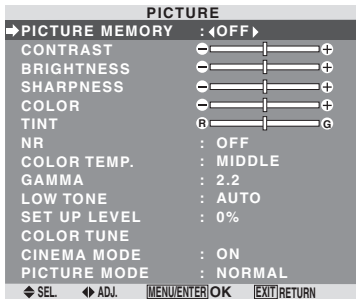

4. Adjust the level or change the setting of the selected item by using the cursor buttons ◀ ▶ on the remote control.



5. The adjustments or the settings that are stored in memory. The change is stored until you change it again.
6. Repeat steps 2 – 5 to adjust an additional item, or press the EXIT button on the remote control to return to the main menu.

\* When adjusting using the bar at the bottom of the screen, press the ◀ or ▶ button within 5 seconds. If not, the current setting is set and the previous screen appears.

**Note:** The main menu disappears by pressing the EXIT button.

## Menu Tree

: Shaded areas indicate the default value.

← → + : Press the ◀ or ▶ button to adjust. The default value is at the center.

Main menu	Sub menu	Sub menu 2	Sub menu 3	Sub menu 4	RESET	REFERENCE	
PICTURE	PICTURE MEMORY	OFF/MEMORY1-6			YES	21	
	CONTRAST	← → + 0 ← 52 → 72			YES	21	
	BRIGHTNESS	← → + 0 ← 32 → 64			YES	21	
	SHARPNESS	← → + 0 ← 16 → 32			YES	21	
	COLOR	← → + 0 ← 32 → 64			YES	21	
	TINT	R ← → G 0 ← 32 → 64			YES	21	
	NR	OFF/NR-1/NR-2/NR-3			YES	21	
	COLOR TEMP.	LOW/MIDDLE LOW/MIDDLE/HIGH			YES	22	
	WHITE BALANCE	GAIN RED	← → + 0 ← → 70			YES	22
		GAIN GREEN	← → + 0 ← → 70			YES	22
		GAIN BLUE	← → + 0 ← → 70			YES	22
		BIAS RED	← → + 0 ← → 70			YES	22
		BIAS GREEN	← → + 0 ← → 70			YES	22
		BIAS BLUE	← → + 0 ← → 70			YES	22
		RESET	OFF ← → ON			YES	22
		GAMMA	2.1 ← 2.2 ← 2.3 → 2.4			YES	22
	LOW TONE	AUTO ← → 1 ← → 3			YES	22	
	SET UP LEVEL	0% ← → 3.75% ← → 7.5%			YES	23	
	COLOR TUNE	RED	Y ← → M 0 ← → 64			YES	23
		GREEN	C ← → Y 0 ← → 64			YES	23
		BLUE	M ← → C 0 ← → 64			YES	23
		YELLOW	G ← → R 0 ← → 64			YES	23
		MAGENTA	R ← → B 0 ← → 64			YES	23
		CYAN	B ← → G 0 ← → 64			YES	23
		RESET	OFF ← → ON			YES	23
		CINEMA MODE	ON ← → OFF			YES	23
	PICTURE MODE	DEFAULT/THEATER1/THEATER2/NORMAL/BRIGHT			YES	23	

Main menu	Sub menu	Sub menu 2	Sub menu 3	Sub menu 4	RESET	REFERENCE
AUDIO	BASS	← → + 0 ← 13 → 26			YES	24
	TREBLE	← → + 0 ← 13 → 26			YES	24
	BALANCE	L ← → R -22 ← 0 → +22			YES	24
	AUDIO INPUT1	VIDEO 1-3 / HD/DVD 1-3 / RGB 1-3			YES	24
	AUDIO INPUT2	VIDEO 1-3 / HD/DVD 1-3 / RGB 1-3			YES	24
	AUDIO INPUT3	VIDEO 1-3 / HD/DVD 1-3 / RGB 1-3			YES	24

Main menu	Sub menu	Sub menu 2	Sub menu 3	Sub menu 4	RESET	REFERENCE
IMAGE ADJUST	ASPECT MODE	ZOOM/NORMAL/ANAMORPHIC/STADIUM/14:9/2.35:1			NO	24
	V-POSITION	← → + -64 ← 0 → +64			YES	24
	H-POSITION	← → + -128 ← 0 → +127			YES	24
	V-HEIGHT	← → + 0 ← → 64			YES	24
	H-WIDTH	← → + 0 ← → 64			YES	24
	AUTO PICTURE	ON ← → OFF*2			NO	24
	FINE PICTURE*1	← → + *2 0 ← → 64			YES	24
	PICTURE ADJ.*1	← → + *2 0 ← → 128			YES	24

Main menu	Sub menu	Sub menu 2	Sub menu 3	Sub menu 4	RESET	REFERENCE	
SET UP	LANGUAGE	ENGLISH/DEUTSCH/FRANÇAIS/ESPAÑOL/ITALIANO/SVENSKA/中文/日本語			NO	25	
	BNC INPUT	RGB ← → COMPONENT			YES	25	
	D-SUB INPUT	RGB			YES	25	
	HD SELECT	1080I/1035I/540P			NO	25	
	RGB SELECT	AUTO/STILL/MOTION/WIDE1/WIDE2/WIDE3/DTV			YES	25	
	HDMI SET UP	PLUG/PLAY	PC ← → STB/DVD			NO	26
		BLACK LEVEL	LOW ← → HIGH			NO	26
	COLOR SYSTEM	AUTO/PAL/PAL-M/PAL-N/PAL 60/SECAM/4.43 NTSC/3.58NTSC			NO	26	
	BACK GROUND	BLACK/GRAY			YES	26	
	GRAY LEVEL	0 ← → 3 ← → 15			YES	27	
	S1/S2	AUTO ← → OFF			YES	27	
	DISPLAY OSM	ON ← → OFF			YES	27	
	OSM ADJ.	TOP LEFT ← → TOP CENTER ← → TOP RIGHT ← → BTM LEFT ← → BTM CENTER ← → BTM RIGHT			YES	27	
	ALL RESET	ON ← → OFF			—	27	

Main menu	Sub menu	Sub menu 2	Sub menu 3	Sub menu 4	RESET	REFERENCE	
FUNCTION	POWER MGT.	ON←→OFF			YES	28	
	INPUT SKIP	ON←→OFF			YES	28	
	PDP SAVER	MANUAL/AUTO				YES	28
		PEAK BRIGHT		100%/75%/50%/25%		YES	29
		ORBITER		OFF/AUTO1/AUTO2		YES	29
		INVERSE/WHITE		OFF/INVERSE/WHITE		YES	29
		SCREEN WIPER		ON/OFF		YES	29
		SOFT FOCUS		OFF/LEVEL1-4		YES	29
		OSM ORBITER		ON/OFF		YES	30
		OSM CONTRAST		LOW/NORMAL		YES	30
	CLOSED CAPTION		OFF/CAPTION1-4/TEXT1-4		YES	30	
	CAPTION CONT		LOW/NORMAL		YES	30	

Main menu	Sub menu	Sub menu 2	Sub menu 3	Sub menu 4	RESET	REFERENCE
SIGNAL INFO.					—	30

\*1 Only when AUTO PICTURE is OFF.

\*2 RGB/PC only

### **Information**

#### **■ Restoring the factory default settings**

Select "ALL RESET" under the SET UP menu. Note that this also restores other settings to the factory defaults.

## Picture Settings Menu

### Storing picture settings

This function allows you to store in memory the current input signal and PICTURE menu settings and to recall these settings when necessary.

There are six picture memories, and notes of up to 15 characters can be added to each.

Example: Storing picture settings at MEMORY1

On "PICTURE MEMORY" of "PICTURE" menu, select "MEMORY1", then press the MENU/ENTER button.

The "PICTURE MEMORY" screen appears.

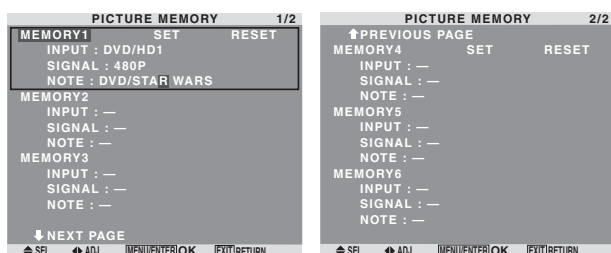

### Information

#### PICTURE MEMORY Settings

OFF: Picture memory not used.

MEMORY1 to 6: Picture memory with the specified number used. Maximum memories are 6, not depending on inputs.

#### Setting the memory

- Use the ▲ and ▼ button to select the desired memory place, MEMORY1 to MEMORY6.
- Use the ◀ and ▶ buttons to select "SET", then press the MENU/ENTER button.
- If necessary, input a note.

#### Resetting the memory

Use the ▲ and ▼ button to select the desired memory place, MEMORY1 to MEMORY6, then use the ◀ and ▶ buttons to select "RESET", and finally press the MENU/ENTER button.

The memory is cleared, and "—" is displayed in the "INPUT", "SIGNAL" and "NOTE" columns.

#### Inputting notes

- Use the ◀ and ▶ buttons to select "NOTE", then press the MENU/ENTER button.
- Input the note.
  - Use the ▲ and ▼ button to select the character.
  - Use the ◀ and ▶ buttons to move the cursor.
  - Use the EXIT button to delete the character at the cursor position.
- When you have finished inputting the note, press the MENU/ENTER button.

## Adjusting the picture

The contrast, brightness, sharpness, color and tint can be adjusted as desired.

Example: Adjusting the contrast

On "CONTRAST" of "PICTURE" menu, adjust the contrast.

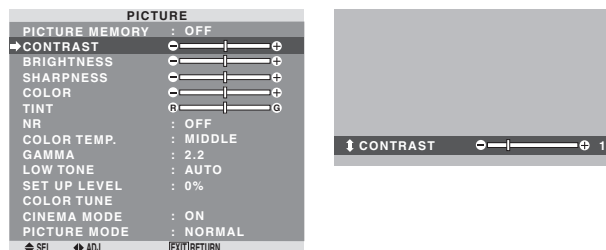

**Note:** If "CAN NOT ADJUST" appears ...

When trying to enter the PICTURE submenu, make sure PICTURE MODE is not set to DEFAULT.

### Information

#### Picture adjustment screen

CONTRAST: Changes the picture's white level.

BRIGHTNESS: Changes the picture's black level.

SHARPNESS: Changes the picture's sharpness.

Adjusts picture detail of VIDEO display.

COLOR: Changes the color density.

TINT: Changes the picture's tint. Adjust for natural colored skin, background, etc.

#### Adjusting the computer image

Only the contrast and brightness can be adjusted when a computer signal is connected.

#### Restoring the factory default settings

Select "DEFAULT" under the "PICTURE MODE" settings.

## Reducing noise in the picture

Use these settings if the picture has noise due to poor reception or when playing video tapes on which the picture quality is poor.

Example: Setting "NR-3"

On "NR" of "PICTURE" menu, select "NR-3".

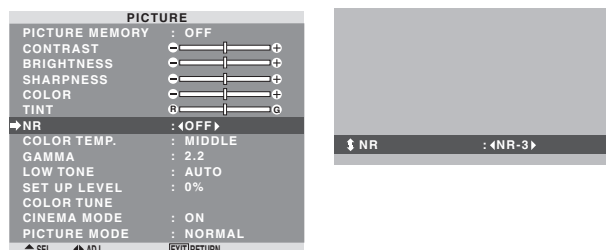

### Information

#### NR

\* "NR" stands for Noise Reduction.

\* This function reduces noise in the picture.

#### Types of noise reduction

There are three types of noise reduction. Each has a different level of noise reduction.

The effect becomes stronger as the number increases (in the order NR-1 → NR-2 → NR-3).

OFF: Turns the noise reduction function off.

## Setting the color temperature

Use this procedure to set color tone produced by the plasma display.

Example: Setting "HIGH"

On "COLOR TEMP." of "PICTURE" menu, select "HIGH".

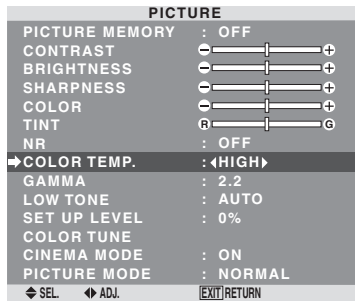

### Information

#### ■ Setting the color temperature

LOW: Redder  
MIDDLE LOW: Slightly red  
MIDDLE: Standard (slightly bluer)  
HIGH: Bluer

## Adjusting the color to the desired level

Use this procedure to adjust the white balance for each color temperature to achieve the desired color quality.

Example: Adjusting the "GAIN RED" of "HIGH" color temperature

On "COLOR TEMP." of "PICTURE" menu, select "HIGH", then press the MENU/ENTER button.

The "WHITE BALANCE" screen appears.

On "GAIN RED", adjust the white balance.

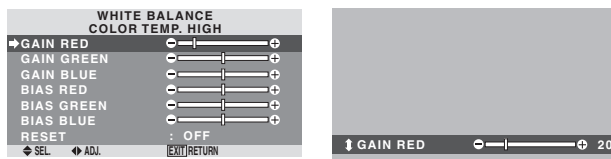

### Information

#### ■ Adjusting the white balance

GAIN R/G/B: White balance adjustment for white level  
BIAS R/G/B: White balance adjustment for black level  
RESET: Resets settings to the factory default values.  
Use ◀ and ▶ buttons to select "ON", then press the MENU/ENTER button.

#### ■ Restoring the factory default settings

Select "RESET" under the WHITE BALANCE menu.

## Changing the Gamma Curve

This feature adjusts the brightness of the midtone areas while keeping shadows and highlights unchanged.

Example: Setting "2.3"

On "GAMMA" of "PICTURE" menu, select "2.3".

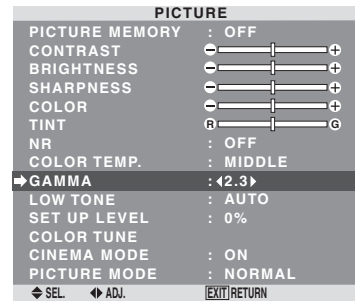

### Information

#### ■ GAMMA settings

The picture becomes darker as the number increases (in the sequence of 2.1, 2.2, 2.3, 2.4).

\* These values are approximate.

## Making the Low Tone adjustments

This feature allows more detailed tone to be reproduced especially in the dark area.

Example: Setting "2"

On "LOW TONE" of "PICTURE" menu, select "2".

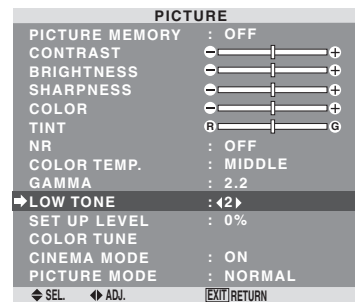

### Information

#### ■ LOW TONE settings

AUTO: Will automatically appraise the picture and make adjustments.

- 1: Will apply the dither method suitable for still pictures.
- 2: Will apply the dither method suitable for motion pictures.
- 3: Will apply the error diffusion method.

## Adjusting the pedestal level (black level)

This feature adjusts the video black level in a video image.

Example: Setting "3.75%"

On "SET UP LEVEL" of "PICTURE" menu, select "3.75%".

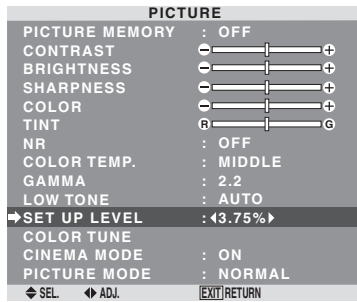

### Information

#### ■ SET UP LEVEL settings

0%: Normal status

3.75%: 3.5% lower than normal

7.5%: 7.5% lower than normal

## Adjusting the colors

Use this procedure to adjust hue and color density for red, green, blue, yellow, magenta and cyan.

You can accentuate the green color of trees, the blue of the sky, etc.

Example: Adjusting the color tune for blue

On "PICTURE" menu, select "COLOR TUNE", then press the MENU/ENTER button.

The "COLOR TUNE" screen appears.

On "BLUE" of "COLOR TUNE", adjust the color tune.

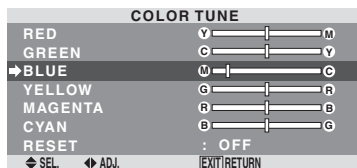

### Information

#### ■ COLOR TUNE settings

RED: Makes red's adjustment

GREEN: Makes green's adjustment

BLUE: Makes blue's adjustment

YELLOW: Makes yellow's adjustment

MAGENTA: Makes magenta's adjustment

CYAN: Makes cyan's adjustment

RESET: Resets settings to the factory default value.

Use ◀ and ▶ buttons to select "ON", then press the MENU/ENTER button.

## Setting the picture to suit the movie

The film image is automatically discriminated and projected in an image mode suited to the picture.

[NTSC, PAL, PAL60, 480I (60Hz), 525I (60Hz), 576I (50Hz), 625I (50Hz), 1035I (60Hz), 1080I (60Hz) only]

Example: Setting the "CINEMA MODE" to "OFF"

On "CINEMA MODE" of "PICTURE" menu, select "OFF".

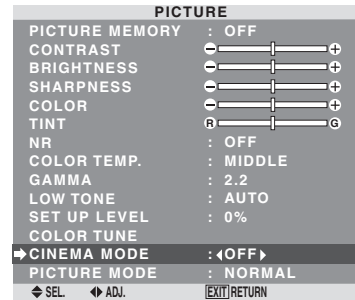

### Information

#### ■ CINEMA MODE

ON: Automatic discrimination of the image and projection in cinema mode.

OFF: Cinema mode does not function.

## Setting the picture mode according to the brightness of the room

There are four picture modes that can be used effectively according to the environment in which you are viewing the display.

Example: Setting the "THEATER1" mode

On "PICTURE MODE" of "PICTURE" menu, select "THEATER1".

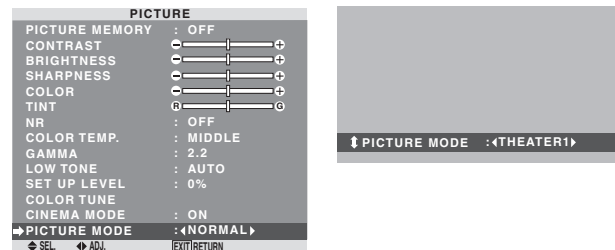

### Information

#### ■ Types of picture modes

THEATER1, 2: Set this mode when watching video in a dark room.

This mode provides darker, finer pictures, like the screen in movie theaters.

For a darker image, select THEATER2.

NORMAL: Set this mode when watching video in a bright room.

This mode provides dynamic pictures with distinct differences between light and dark sections.

BRIGHT: This mode provides brighter pictures than NORMAL.

DEFAULT: Use this to reset the picture to the factory default settings.



## Audio Settings Menu

### Adjusting the treble, bass and left/right balance and audio input select

The treble, bass and left/right balance can be adjusted to suit your tastes.

Example: Adjusting the bass

On "BASS" of "AUDIO" menu, adjust the bass.

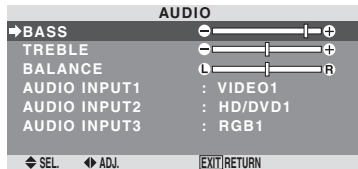

**Note :** If "CAN NOT ADJUST" appears...  
Set "AUDIO INPUT" on the AUDIO menu correctly.

### Information

#### ■ Audio settings menu

**BASS:** Controls the level of low frequency sound.  
**TREBLE:** Controls the level of high frequency sound.  
**BALANCE:** Controls the balance of the left and right channels.

### Setting the allocation of the audio connectors

Setting the AUDIO 1, 2, and 3 connectors to the desired input.

Example: Setting "AUDIO INPUT1" to "VIDEO 2"

On "AUDIO INPUT1" of "AUDIO" menu, select "VIDEO2".

The available sources depend on the settings of input.

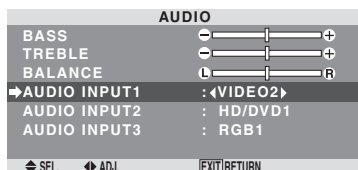

### Information

#### ■ AUDIO INPUT

A single audio input cannot be selected as the audio channel for more than one input terminal.

## Image Adjust Settings Menu

### Adjusting the Position, Size, Fine Picture, Picture ADJ.

The position of the image can be adjusted and flickering of the image can be corrected.

Example: Adjusting the vertical position in the normal mode

On "V-POSITION" of "IMAGE ADJUST" menu, adjust the position.

The mode switches as follows each time the ◀ or ▶ button is pressed:

**NORMAL** ↔ **ANAMORPHIC**

\* The mode can also be switched by pressing the WIDE button on the remote control.

\* The settings on the IMAGE ADJUST menu are not preset at the factory.

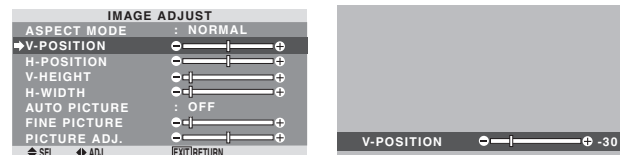

### Information

#### ■ When "AUTO PICTURE" is "OFF"

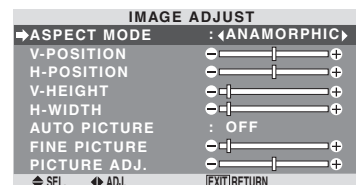

When Auto Picture is off, the Fine Picture and the Picture ADJ. items are displayed so that you can adjust them.

#### ■ Adjusting the Auto Picture

**ON:** The Picture ADJ., Fine Picture and Position adjustments are made automatically.

Not available for digital ZOOM.

**OFF:** The Picture ADJ., Fine Picture and Position adjustments are made manually.

\* If FINE PICTURE can't be adjusted, set Auto Picture to OFF and adjust manually.

#### ■ Adjusting the position of the image

**V-POSITION:** Adjusts the vertical position of the image.

**H-POSITION:** Adjusts the horizontal position of the image.

**V-HEIGHT:** Adjusts the vertical size of the image. (Except for STADIUM mode)

**H-WIDTH:** Adjusts the horizontal size of the image. (Except for STADIUM mode)

**FINE PICTURE\*:** Adjusts for flickering.

**PICTURE ADJ.\*:** Adjusts for striped patterns on the image.

\* The Picture ADJ. and Fine Picture features are available only when the "Auto Picture" is off.

\* The AUTO PICTURE, FINE PICTURE and PICTURE ADJ. are available only for RGB signals.

But, these features are not available for moving pictures on VIDEO, HD/DVD or RGB.

## SET UP Settings Menu

### Setting the language for the menus

The menu display can be set to one of eight languages.

Example: Setting the menu display to “DEUTSCH”

On “LANGUAGE” of “SET UP” menu, select “DEUTSCH”.

SET UP	
→ LANGUAGE	: <DEUTSCH>
BNC INPUT	: COMPONENT
D-SUB INPUT	: RGB
HD SELECT	: 1080I
RGB SELECT	: PC AUTO
HDMI SET UP	
COLOR SYSTEM	: AUTO
BACK GROUND	: GRAY
GRAY LEVEL	: 3
S1/S2	: OFF
DISPLAY OSM	: ON
OSM ADJ.	: TOP LEFT
ALL RESET	: OFF
◀ SEL	▶ ADJ. [EXIT] RETURN

#### Information

##### ■ Language settings

ENGLISH .....	English	ITALIANO .....	Italian
DEUTSCH .....	German	SVENSKA .....	Swedish
FRANÇAIS .....	French	中文 .....	Chinese
ESPAÑOL .....	Spanish	РУССКИЙ .....	Russian

### Setting the BNC connectors

Select whether to set the input of the 5 BNC connectors to RGB and component.

Example: Set the BNC INPUT mode to “RGB”

On “BNC INPUT” of “SET UP” menu, select “RGB”.

SET UP	
LANGUAGE	: ENGLISH
→ BNC INPUT	: <RGB>
D-SUB INPUT	: RGB
HD SELECT	: 1080I
RGB SELECT	: PC AUTO
HDMI SET UP	
COLOR SYSTEM	: AUTO
BACK GROUND	: GRAY
GRAY LEVEL	: 3
S1/S2	: OFF
DISPLAY OSM	: ON
OSM ADJ.	: TOP LEFT
ALL RESET	: OFF
◀ SEL	▶ ADJ. [EXIT] RETURN

#### Information

##### ■ BNC INPUT Settings

RGB: Use the 5BNC terminals for RGB input.

COMPONENT: Use the 3BNC terminals for component input.

### Checking the signal being transmitted to RGB1 terminal

Use this to confirm the signal being transmitted to the RGB1 terminal.

It is set to RGB and can not be adjusted.

SET UP	
LANGUAGE	: ENGLISH
BNC INPUT	: COMPONENT
→ D-SUB INPUT	: RGB
HD SELECT	: 1080I
RGB SELECT	: PC AUTO
HDMI SET UP	
COLOR SYSTEM	: AUTO
BACK GROUND	: GRAY
GRAY LEVEL	: 3
S1/S2	: OFF
DISPLAY OSM	: ON
OSM ADJ.	: TOP LEFT
ALL RESET	: OFF
CAN NOT ADJUST	

### Setting high definition images to the suitable screen size

Use this procedure to set whether the number of vertical lines of the input high definition image is 1080I or 1035I or 540P.

Example: Setting the “HD SELECT” mode to “1035I”

On “HD SELECT” of “SET UP” menu, select “1035I”.

SET UP	
LANGUAGE	: ENGLISH
BNC INPUT	: COMPONENT
D-SUB INPUT	: RGB
→ HD SELECT	: <1035I>
RGB SELECT	: PC AUTO
HDMI SET UP	
COLOR SYSTEM	: AUTO
BACK GROUND	: GRAY
GRAY LEVEL	: 3
S1/S2	: OFF
DISPLAY OSM	: ON
OSM ADJ.	: TOP LEFT
ALL RESET	: OFF
◀ SEL	▶ ADJ. [EXIT] RETURN

#### Information

##### ■ HD SELECT modes

These 3 modes are not displayed in correct image automatically.

1080I: Standard digital broadcasts

1035I: Japanese “High Vision” signal format

540P: Special Digital broadcasts (for example : DTC100)

### Setting a computer image to the correct RGB select screen

With the computer image, select the RGB Select mode for a moving image such as (video) mode, wide mode or digital broadcast.

Example: Setting the “RGB SELECT” mode to “MOTION”

On “RGB SELECT” of “SET UP” menu, select “MOTION”.

SET UP	
LANGUAGE	: ENGLISH
BNC INPUT	: COMPONENT
D-SUB INPUT	: RGB
HD SELECT	: 1080I
→ RGB SELECT	: <MOTION>
HDMI SET UP	: 1024 × 768
COLOR SYSTEM	: AUTO
BACK GROUND	: GRAY
GRAY LEVEL	: 3
S1/S2	: OFF
DISPLAY OSM	: ON
OSM ADJ.	: TOP LEFT
ALL RESET	: OFF
◀ SEL	▶ ADJ. [EXIT] RETURN

## Information

### ■ RGB SELECT modes

One of these 7 modes must be selected in order to display the following signals correctly.

**PC AUTO:** Select the suitable mode for the specifications of input signals as listed in the table “Computer input signals supported by this system” on page 38-40.

**STILL:** To display VESA standard signals. (Use this mode for a still image from a computer.)

**MOTION:** The video signal (from a scan converter) will be converted to RGB signals to make the picture more easily viewable. (Use this mode for a motion image from a computer.)

**WIDE1:** When an 852 dot × 480 line signal with a horizontal frequency of 31.7kHz is input, the image may be compressed horizontally. To prevent this, set RGB SELECT to WIDE1.

**WIDE2:** When an 848 dot × 480 line signal with a horizontal frequency of 31.0 kHz is input, the image may be compressed horizontally. To prevent this, set RGB SELECT to WIDE2.

**WIDE3:** When an 1920 dot × 1200 line signal with a horizontal frequency of 74.0 kHz is input, the image may be compressed horizontally. To prevent this, set RGB SELECT to WIDE3.

**DTV:** Set this mode when watching digital broadcasting (480P/720P/1080I/576P).

See page 38-40 for the details of the above settings.

## Setting the signal and black level for HDMI signal

Choose the signal for the HDMI connector (PC or STB/DVD) and set the black level.

Example: Setting the “PLUG/PLAY” mode to “STB/DVD”

On “SET UP” menu, select “HDMI SET UP”, then press the MENU/ENTER button.

The “HDMI SET UP” screen appears.

On “PLUG/PLAY” of “HDMI SET UP” menu, select “STB/DVD”.

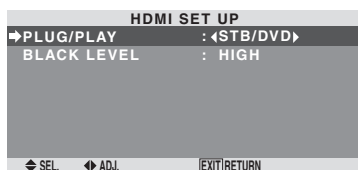

## Information

### ■ PLUG/PLAY settings

**PC:** When connected to the PC signal.

**BLACK LEVEL** is set to “LOW” automatically.

**STB/DVD:** When connected to the SET TOP BOX, DVD etc.

**BLACK LEVEL** is set to “HIGH” automatically.

### ■ BLACK LEVEL settings

**LOW:** When connected to the PC signal.

**HIGH:** When connected to the SET TOP BOX, DVD etc. Change “HIGH” into “LOW” if the black level appears gray.

## Setting the video signal format

Use these operations to set the color systems of composite video signals or Y/C input signals.

Example: Setting the color system to “3.58 NTSC”

On “COLOR SYSTEM” of “SET UP” menu, select “3.58NTSC”.



## Information

### ■ Video signal formats

Different countries use different formats for video signals. Set to the color system used in your current country.

**AUTO:** The color systems are automatically identified and the format is set accordingly.

**PAL:** This is the standard format used mainly in the United Kingdom and Germany.

**SECAM:** This is the standard format used mainly in France and Russia.

**4.43 NTSC, PAL60:** This format is used for videos in countries using PAL and SECAM video signals.

**3.58 NTSC:** This is the standard format used mainly in the United States and Japan.

**PAL-M:** This is the standard format used mainly in Brazil.

**PAL-N:** This is the standard format used mainly in Argentina.

## Setting the background color when no signal is being input

The color displayed on the background when there is no signal can be set to gray.

Example: Setting “BACK GROUND” to “BLACK”

On “BACK GROUND” of “SET UP” menu, select “BLACK”.



## Information

### ■ BACK GROUND Settings

**BLACK:** Sets the background color to black.

**GRAY:** Sets the background color to gray.

Setting this makes it easier to see that there is no signal.

## Setting the gray level for the sides of the screen

Use this procedure to set the gray level for the parts on the screen on which nothing is displayed when the screen is set to the 4:3 size.

Example: Setting "GRAY LEVEL" to "5"

On "GRAY LEVEL" of "SET UP" menu, select "5".

SET UP	
LANGUAGE	: ENGLISH
BNC INPUT	: COMPONENT
D-SUB INPUT	: RGB
HD SELECT	: 1080I
RGB SELECT	: PC AUTO
HDMI SET UP	
COLOR SYSTEM	: AUTO
BACK GROUND	: GRAY
→GRAY LEVEL	: 5
S1/S2	: OFF
DISPLAY OSM	: ON
OSM ADJ.	: TOP LEFT
ALL RESET	: OFF
◀SEL	▶ADJ. EXIT/RETURN

### Information

#### ■ GRAY LEVEL settings

This adjusts the brightness of the black (the gray level) for the sides of the screen.

The standard is 0 (black). The level can be adjusted from 0 to 15. The factory setting is 3 (dark gray).

## Setting the screen size for S1/S2 video input

If the S-video signal contains screen size information, the image will be automatically adjusted to fit the screen when this S1/S2 is set to AUTO.

This feature is available only when an S-video signal is input via the VIDEO3 terminal.

Example: Setting "S1/S2" to "AUTO"

On "S1/S2" of "SET UP" menu, select "AUTO".

SET UP	
LANGUAGE	: ENGLISH
BNC INPUT	: COMPONENT
D-SUB INPUT	: RGB
HD SELECT	: 1080I
RGB SELECT	: PC AUTO
HDMI SET UP	
COLOR SYSTEM	: AUTO
BACK GROUND	: GRAY
GRAY LEVEL	: 3
→S1/S2	: AUTO
DISPLAY OSM	: ON
OSM ADJ.	: TOP LEFT
ALL RESET	: OFF
◀SEL	▶ADJ. EXIT/RETURN

### Information

#### ■ S1/S2 settings

AUTO: Adjusts the screen size automatically according to the S1/S2 video signal.

OFF: Turns the S1/S2 function off.

## Turning on/off the menu display

When this is set to OFF, the menu will not displayed even if you press the MENU/ENTER button.

Example: Turning the DISPLAY OSM off

On "DISPLAY OSM" of "SET UP" menu, select "OFF".

SET UP	
LANGUAGE	: ENGLISH
BNC INPUT	: COMPONENT
D-SUB INPUT	: RGB
HD SELECT	: 1080I
RGB SELECT	: PC AUTO
HDMI SET UP	
COLOR SYSTEM	: AUTO
BACK GROUND	: GRAY
GRAY LEVEL	: 3
S1/S2	: OFF
→DISPLAY OSM	: OFF
OSM ADJ.	: TOP LEFT
ALL RESET	: OFF
◀SEL	▶ADJ. EXIT/RETURN

### Information

#### ■ DISPLAY OSM settings

ON: The on-screen menu appears.

OFF: The on-screen menu does not appear.

If you press the DISPLAY button on the remote control for more than 3 seconds the main menu will appear and can be set (although it is not ON).

## Setting the position of the menu

Adjusts the position of the menu when it appears on the screen.

Example: Set the position to "TOP CENTER"

On "OSM ADJ." of "SET UP" menu, select "TOP CENTER".

SET UP	
LANGUAGE	: ENGLISH
BNC INPUT	: COMPONENT
D-SUB INPUT	: RGB
HD SELECT	: 1080I
RGB SELECT	: PC AUTO
HDMI SET UP	
COLOR SYSTEM	: AUTO
BACK GROUND	: GRAY
GRAY LEVEL	: 3
S1/S2	: OFF
DISPLAY OSM	: ON
→OSM ADJ.	: TOP CENTER
ALL RESET	: OFF
◀SEL	▶ADJ. EXIT/RETURN

### Information

#### ■ OSM ADJUST settings

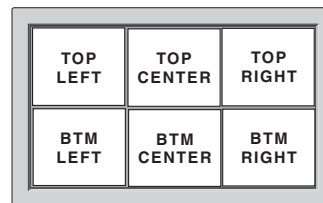

## Resetting to the default values

Use these operations to restore all the settings (PICTURE, AUDIO, IMAGE ADJUST, SET UP, etc) to the factory default values.

Refer to page 19 for items to be reset.

On "ALL RESET" of "SET UP" menu, select "ON", then press the MENU/ENTER button.

SET UP	
LANGUAGE	: ENGLISH
BNC INPUT	: COMPONENT
D-SUB INPUT	: RGB
HD SELECT	: 1080I
RGB SELECT	: PC AUTO
HDMI SET UP	
COLOR SYSTEM	: AUTO
BACK GROUND	: GRAY
GRAY LEVEL	: 3
S1/S2	: OFF
DISPLAY OSM	: ON
OSM ADJ.	: TOP LEFT
→ALL RESET	: ON
◀SEL	▶ADJ. EXIT/RETURN



When the "SETTING NOW" screen disappears, then all the settings are restored to the default values.

## Function Settings Menu

### Setting the power management for computer images

This energy-saving (power management) function automatically reduces the monitor's power consumption if no operation is performed for a certain amount of time.

Example: Turning the power management function on

On "POWER MGT." of "FUNCTION" menu, select "ON".

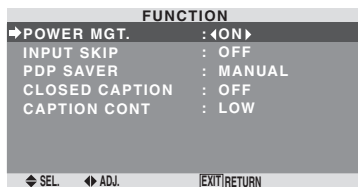

#### Information

##### ■ Power management function

- \* The power management function automatically reduces the monitor's power consumption if the computer's keyboard or mouse is not operated for a certain amount of time. This function can be used when using the monitor with a computer.
- \* If the computer's power is not turned on or if the computer and selector tuner are not properly connected, the system is set to the off state.
- \* For instructions on using the computer's power management function, refer to the computer's operating instructions.

##### ■ Power management settings

ON: In this mode the power management function is turned on.

OFF: In this mode the power management function is turned off.

##### ■ Power management function and POWER/STANDBY indicator

The POWER/STANDBY indicator indicates the status of the power management function. See below for indicator status and description.

### POWER/STANDBY indicator

Power management mode	POWER/STANDBY indicator	Power management operating status	Description	Turning the picture back on
On	Green	Not activated.	Horizontal and vertical synchronizing signals are present from the computer.	Picture already on.
Off	Red	Activated.	Horizontal and/or vertical synchronizing signals are not sent from the computer.	Operate the keyboard or mouse. The picture reappears.

### Setting the Input Skip

When this is ON, signals which are not present will be skipped over and only pictures whose signals are being transmitted will be displayed.

This setting is valid only for the INPUT SELECT button on the unit.

Example: Set to "ON"

On "INPUT SKIP" of "FUNCTION" menu, select "ON".

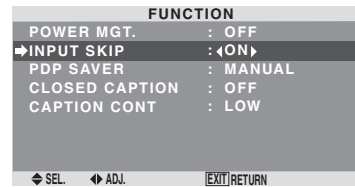

#### Information

##### ■ INPUT SKIP settings

OFF: Regardless of the presence of the signal, scan and display all signals.

ON: If no input signal is present, skip that signal.

\* "SETTING NOW" will appear during the input search.

### Reducing burn-in of the screen

The brightness of the screen, the position of the picture, positive/negative mode and screen wiper are adjusted to reduce burn-in of the screen.

On "PDP SAVER" of "FUNCTION" menu, select "MANUAL", then press the MENU/ENTER button.

The "PDP SAVER" screen appears.

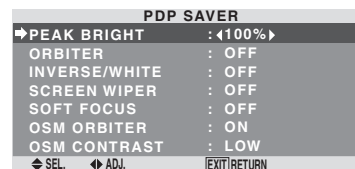

#### Information

##### ■ When set to AUTO

Set automatically, as described below.

PEAK BRIGHT: 100%

ORBITER: ON

INVERSE/WHITE: OFF

SCREEN WIPER: OFF

SOFT FOCUS: OFF

OSD ORBITER: ON

OSD CONTRAST: LOW

## PEAK BRIGHT

Use this to activate the brightness limiter.

Example: Setting "PEAK BRIGHT" to "75%"

On "PEAK BRIGHT" of "PDP SAVER" menu, select "75%".

PDP SAVER	
→ PEAK BRIGHT	: 75% ▶
ORBITER	: OFF
INVERSE/WHITE	: OFF
SCREEN WIPER	: OFF
SOFT FOCUS	: OFF
OSM ORBITER	: ON
OSM CONTRAST	: LOW
◀ SEL.	▶ ADJ. [EXIT] RETURN

### Information

#### ■ PEAK BRIGHT settings

100%: The brightness of the screen is adjusted automatically to suit the picture quality.

75%, 50%, 25%: Sets maximum brightness.

The brightness level decreases in the order of 75%, 50%, 25%. 25% provides minimum brightness.

\* These values are approximate.

## ORBITER

Use this to set the picture shift.

Example: Setting "ORBITER" to "AUTO1"

On "ORBITER" of "PDP SAVER" menu, select "AUTO1".

PDP SAVER	
PEAK BRIGHT	: 100%
→ ORBITER	: <AUTO1>
INVERSE/WHITE	: OFF
SCREEN WIPER	: OFF
SOFT FOCUS	: OFF
OSM ORBITER	: ON
OSM CONTRAST	: LOW
◀ SEL.	▶ ADJ. [EXIT] RETURN

### Information

#### ■ ORBITER settings

OFF: Orbiter mode does not function.

This is the default setting when RGB is input.

AUTO1: The picture moves around the screen intermittently, making the picture smaller. This is the default setting when a Video or a DVD/HD/DTV signal is input. Set to "OFF" when these signals are not used.

AUTO2: The picture moves around the screen intermittently, making the picture bigger.

\* When a Video or a DVD/HD/DTV signal is input, the AUTO1 and 2 functions will affect only the moving picture and will not make the screen smaller or bigger.

## INVERSE/WHITE

Use this to set the inverse mode or to display a white screen.

Example: Setting "INVERSE/WHITE" to "WHITE"

On "INVERSE/WHITE" of "PDP SAVER" menu, select "WHITE".

PDP SAVER	
PEAK BRIGHT	: 100%
ORBITER	: OFF
→ INVERSE/WHITE	: <WHITE>
SCREEN WIPER	: OFF
SOFT FOCUS	: OFF
OSM ORBITER	: ON
OSM CONTRAST	: LOW
◀ SEL.	▶ ADJ. [EXIT] RETURN

### Information

#### ■ INVERSE/WHITE Settings

OFF: Inverse/white mode does not function.

INVERSE: The picture is displayed alternately between positive image and negative image.

WHITE: The entire screen turns white.

## SCREEN WIPER

When this is set to ON, a white vertical bar moves repeatedly from the left and of the screen to the right end at a constant speed.

Example: Setting "SCREEN WIPER" to "ON"

On "SCREEN WIPER" of "PDP SAVER" menu, select "ON".

PDP SAVER	
PEAK BRIGHT	: 100%
ORBITER	: OFF
INVERSE/WHITE	: OFF
→ SCREEN WIPER	: <ON>
SOFT FOCUS	: OFF
OSM ORBITER	: ON
OSM CONTRAST	: LOW
◀ SEL.	▶ ADJ. [EXIT] RETURN

### Information

#### ■ SCREEN WIPER

ON: The white vertical bar appears.

OFF: Screen wiper mode does not function.

## SOFT FOCUS

Reduces edges and softens the image.

Example: Setting "SOFT FOCUS" to "LEVEL2"

On "SOFT FOCUS" of "PDP SAVER" menu, select "LEVEL2".

PDP SAVER	
PEAK BRIGHT	: 100%
ORBITER	: OFF
INVERSE/WHITE	: OFF
SCREEN WIPER	: OFF
→ SOFT FOCUS	: <LEVEL2>
OSM ORBITER	: ON
OSM CONTRAST	: LOW
◀ SEL.	▶ ADJ. [EXIT] RETURN

### Information

#### ■ SOFT FOCUS settings

OFF: Turns the SOFT FOCUS function off.

LEVEL1, 2, 3, 4: Activates the SOFT FOCUS setting.

The higher numbers create a softer image.

"SHARPNESS" can not be adjusted on the "PICTURE" menu.

## OSM ORBITER

Use this to set OSM menu shift.

Example: Setting "OSM ORBITER" to "OFF"

On "OSM ORBITER" of "PDP SAVER" menu, select "OFF".

PDP SAVER	
PEAK BRIGHT	: 100%
ORBITER	: OFF
INVERSE/WHITE	: OFF
SCREEN WIPER	: OFF
SOFT FOCUS	: OFF
OSM ORBITER	: <OFF>
OSM CONTRAST	: LOW
◀SEL. ▶ADJ. [EXIT]RETURN	

### Information

#### ■ OSM ORBITER settings

ON: The position of the menu will be shifted by eight dots each time OSM is displayed.

OFF: OSM will be displayed at the same position.

## OSM CONTRAST

Use this to reduce the brightness of OSM menu.

Example: Setting "OSM CONTRAST" to "NORMAL"

On "OSM CONTRAST" of "PDP SAVER" menu, select "NORMAL".

PDP SAVER	
PEAK BRIGHT	: 100%
ORBITER	: OFF
INVERSE/WHITE	: OFF
SCREEN WIPER	: OFF
SOFT FOCUS	: OFF
OSM ORBITER	: ON
OSM CONTRAST	: <NORMAL>
◀SEL. ▶ADJ. [EXIT]RETURN	

### Information

#### ■ OSM CONTRAST settings

NORMAL: OSM brightness is set to normal.

LOW: OSM brightness is set to lower.

## Setting Closed Caption

This function sets several closed caption modes that allows text to be superimposed on display.

Example: Setting "CAPTION2"

On "CLOSED CAPTION" of "FUNCTION" menu, select "CAPTION2".

FUNCTION	
POWER MGT.	: OFF
INPUT SKIP	: OFF
PDP SAVER	: MANUAL
CLOSED CAPTION	: <CAPTION2>
CAPTION CONT	: LOW
◀SEL. ▶ADJ. [EXIT]RETURN	

### Information

#### ■ CLOSED CAPTION settings

OFF: This exits the closed caption mode.

CAPTION1~4: Text is superimposed.

TEXT1~4: Text is displayed in full screen.

A closed caption signal may not be decoded in the following signature;

1. when a video tape has been dubbed.
2. when the signal reception is weak.
3. when the signal reception is nonstandard.

When using closed captioned channel or the text mode, the text screen always appears.

When there is no signal, however, the text screen will not display text characters.

## Reducing the brightness of Closed Caption

Use this to reduce the brightness of Closed Caption.

Example: Setting "NORMAL"

On "CAPTION CONT" of "FUNCTION" menu, select "NORMAL".

FUNCTION	
POWER MGT.	: OFF
INPUT SKIP	: OFF
PDP SAVER	: MANUAL
CLOSED CAPTION	: OFF
CAPTION CONT	: <NORMAL>
◀SEL. ▶ADJ. [EXIT]RETURN	

### Information

#### ■ CAPTION CONT settings

NORMAL: Closed Caption brightness is set to normal.

LOW: Closed Caption brightness is set to lower.

## Signal Information Menu

### Checking the frequencies, polarities of input signals, and resolution

Use this function to check the frequencies and polarities of the signals currently being input from a computer, etc. On "MAIN MENU", select "SIGNAL INFO.", then press the MENU/ENTER button.

The "SIGNAL INFORMATION" is displayed.

SIGNAL INFORMATION	
H. FREQUENCY	: 48.4KHz
V. FREQUENCY	: 60.0Hz
H. POLARITY	: NEGATIVE
V. POLARITY	: NEGATIVE
MEMORY	: 24
RESOLUTION	: 1024 × 768
◀SEL. ▶ADJ. [EXIT]RETURN	

PC: MEMORY will be displayed.  
Others: MODE will be displayed.

# External Control

# Pin Assignments

## Application

These specifications cover the communications control of the plasma monitor by external equipment.

## Connections

Connections are made as described below.

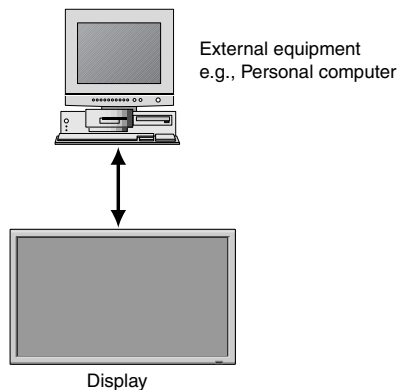

Connector on the plasma monitor side: EXTERNAL CONTROL connector.

Use a crossed (reverse) cable.

### Type of connector: D-Sub 9-pin male

Pin No.	Pin Name	Pin No.	Pin Name
1	No Connection	6	DSR (DCE side ready)
2	RXD (Receive data)	7	RTS (Ready to send)
3	TXD (Transmit data)	8	CTS (Clear to send)
4	DTR (DTE side ready)	9	No connection
5	GND		

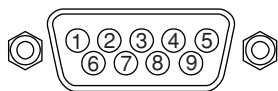

## Communication Parameters

- |                          |              |
|--------------------------|--------------|
| (1) Communication system | Asynchronous |
| (2) Interface            | RS-232C      |
| (3) Baud rate            | 9600 bps     |
| (4) Data length          | 8 bits       |
| (5) Parity               | Odd          |
| (6) Stop bit             | 1 bit        |
| (7) Communication code   | Hex          |

## External Control Codes (Reference)

FUNCTION		CODE DATA							
Power ON		9FH	80H	60H	4EH	00H	CDH		
OFF		9FH	80H	60H	4FH	00H	CEH		
Input Switch	Video1 (BNC)	DFH	80H	60H	47H	01H	08H		
	Video2 (RCA)	DFH	80H	60H	47H	01H	02H		
	Video3 (S-Video)	DFH	80H	60H	47H	01H	03H		
	DVD1/HD1 (RCA)	DFH	80H	60H	47H	01H	05H		
	DVD2/HD2 (BNC)	DFH	80H	60H	47H	01H	06H		
	DVD3/HD3 (HDMI)	DFH	80H	60H	47H	01H	0EH		
	RGB1 (mini D-sub 15-pin)	DFH	80H	60H	47H	01H	07H		
	RGB2 (5BNC)	DFH	80H	60H	47H	01H	08H		
	RGB3 (HDMI)	DFH	80H	60H	47H	01H	0CH		
Audio Mute	ON	9FH	80H	60H	3EH	00H	BDH		
	OFF	9FH	80H	60H	3FH	00H	BEH		
Picture Mode	NORMAL	DFH	80H	60H	0AH	01H	01H		CBH
	THEATER 1	DFH	80H	60H	0AH	01H	02H		CCH
	THEATER 2	DFH	80H	60H	0AH	01H	03H		CDH
	DEFAULT	DFH	80H	60H	0AH	01H	04H		CEH
	BRIGHT	DFH	80H	60H	0AH	01H	05H		CFH
Screen Mode	STADIUM	DFH	80H	60H	51H	01H	02H		13H
	ZOOM	DFH	80H	60H	51H	01H	03H		14H
	NORMAL	DFH	80H	60H	51H	01H	04H		15H
	ANAMORPHIC	DFH	80H	60H	51H	01H	05H		16H
	14 : 9	DFH	80H	60H	51H	01H	09H		1AH
	2.35 : 1	DFH	80H	60H	51H	01H	0AH		1BH
Auto Picture	ON	DFH	80H	60H	7FH	03H	03H		09H 00H 4DH
	OFF	DFH	80H	60H	7FH	03H	03H		09H 01H 4EH
Cinema Mode	ON	DFH	80H	60H	C1H	01H	01H		82H
	OFF	DFH	80H	60H	C1H	01H	02H		83H

**Note:** Contact your local dealer for a full list of the External Control Codes if needed.

## mini D-Sub 15-pin connector (Analog)

RGB 1

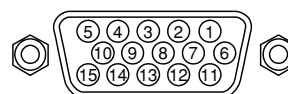

Pin No.	Signal (Analog)
1	Red
2	Green or sync-on-green
3	Blue
4	No connection
5	Ground
6	Red ground
7	Green ground
8	Blue ground
9	No connection
10	Sync signal ground
11	No connection
12	Bi-directional DATA (SDA)
13	Horizontal sync or Composite sync
14	Vertical sync
15	Data clock

## HDMI connector (Digital)

The unit is equipped with a type of connector commonly used for digital.

(This cannot be used for an analog input.)

(TMDS can be used for one link only.)

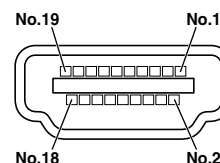

Pin No.	Signal (Digital)
1	TMDS Data 2+
2	TMDS Data 2 Shield
3	TMDS Data 2-
4	TMDS Data 1+
5	TMDS Data 1 Shield
6	TMDS Data 1-
7	TMDS Data 0+
8	TMDS Data 0 Shield
9	TMDS Data 0-
10	TMDS Clock+
11	TMDS Clock Shield
12	TMDS Clock-
13	CEC
14	Reserved (in cable but N.C. on device)
15	SCL
16	SDA
17	DDC/CEC Ground
18	+5V Power
19	Hot Plug Detect



# Troubleshooting

If the picture quality is poor or there is some other problem, check the adjustments, operations, etc., before requesting service.

Symptom	Checks	Remedy
Mechanical sound is heard.	<ul style="list-style-type: none"> <li>• Maybe the sound from the cooling fans used to prevent over heating.</li> </ul>	
The unit emits a crackling sound.	<ul style="list-style-type: none"> <li>• Are the image and sound normal?</li> </ul>	<ul style="list-style-type: none"> <li>• If there are no abnormalities in the image and sound, the noise is caused by the cabinet reacting to changes in temperature. This will not affect performance.</li> </ul>
Picture is disturbed. Sound is noisy. Remote control operates erroneously.	<ul style="list-style-type: none"> <li>• Is a connected component set directly in front or at the side of the display?</li> </ul>	<ul style="list-style-type: none"> <li>• Leave some space between the display and the connected components.</li> </ul>
The remote control does not work.	<ul style="list-style-type: none"> <li>• Are the remote control's batteries worn out?</li> </ul>	<ul style="list-style-type: none"> <li>• Replace both batteries with new ones.</li> </ul>
Monitor's power does not turn on when the remote control's power button is pressed.	<ul style="list-style-type: none"> <li>• Is the monitor's power cord plugged into a power outlet?</li> </ul>	<ul style="list-style-type: none"> <li>• Plug the monitor's power cord into a power outlet.</li> </ul>
	<ul style="list-style-type: none"> <li>• Are all the monitor's indicators off?</li> </ul>	<ul style="list-style-type: none"> <li>• Press the power button on the monitor to turn on the power.</li> </ul>
	<ul style="list-style-type: none"> <li>• Are the remote control's batteries worn out?</li> </ul>	<ul style="list-style-type: none"> <li>• Replace both batteries with new ones.</li> </ul>
Monitor does not operate when the remote control's buttons are pressed.	<ul style="list-style-type: none"> <li>• Is the remote control pointed at the monitor, or is there an obstacle between the remote control and the monitor?</li> </ul>	<ul style="list-style-type: none"> <li>• Point the remote control at the monitor's remote control sensor when pressing buttons, or remove the obstacle.</li> </ul>
	<ul style="list-style-type: none"> <li>• Is direct sunlight or strong artificial light shining on the monitor's remote control sensor?</li> </ul>	<ul style="list-style-type: none"> <li>• Eliminate the light by closing curtains, pointing the light in a different direction, etc.</li> </ul>
	<ul style="list-style-type: none"> <li>• Are the remote control's batteries worn out?</li> </ul>	<ul style="list-style-type: none"> <li>• Replace both batteries with new ones.</li> </ul>
No sound or picture is produced.	<ul style="list-style-type: none"> <li>• Is the monitor's power cord plugged into a power outlet?</li> </ul>	<ul style="list-style-type: none"> <li>• Plug the monitor's power cord into a power outlet.</li> </ul>
Picture appears but no sound is produced.	<ul style="list-style-type: none"> <li>• Is the volume set at the minimum?</li> </ul>	<ul style="list-style-type: none"> <li>• Increase the volume.</li> </ul>
	<ul style="list-style-type: none"> <li>• Is the mute mode set?</li> </ul>	<ul style="list-style-type: none"> <li>• Press the remote control's MUTE button.</li> </ul>
	<ul style="list-style-type: none"> <li>• Are the speakers properly connected?</li> </ul>	<ul style="list-style-type: none"> <li>• Connect the speakers properly.</li> </ul>
	<ul style="list-style-type: none"> <li>• Is AUDIO INPUT set correctly?</li> </ul>	<ul style="list-style-type: none"> <li>• Set AUDIO INPUT on the AUDIO menu correctly.</li> </ul>
Poor picture with VIDEO signal input.	<ul style="list-style-type: none"> <li>• Improper control setting.</li> <li>• Local interference.</li> <li>• Cable interconnections.</li> <li>• Input impedance is not correct level.</li> </ul>	<ul style="list-style-type: none"> <li>• Adjust picture control as needed.</li> <li>• Try another location for the monitor.</li> <li>• Be sure all connections are secure.</li> </ul>
Poor picture with RGB signal input.	<ul style="list-style-type: none"> <li>• Improper control setting.</li> <li>• Incorrect 15 PIN connector pin connections.</li> </ul>	<ul style="list-style-type: none"> <li>• Adjust picture controls as needed.</li> <li>• Check pin assignments and connections.</li> </ul>
Tint is poor or colors are weak.	<ul style="list-style-type: none"> <li>• Are the tint and colors properly adjusted?</li> </ul>	<ul style="list-style-type: none"> <li>• Adjust the tint and color (under PICTURE).</li> </ul>
Nothing appears on screen.	<ul style="list-style-type: none"> <li>• Is the computer's power turned on?</li> </ul>	<ul style="list-style-type: none"> <li>• Turn on the computer's power.</li> </ul>
	<ul style="list-style-type: none"> <li>• Is a source connected?</li> </ul>	<ul style="list-style-type: none"> <li>• Connect source to the monitor.</li> </ul>
	<ul style="list-style-type: none"> <li>• Is the power management function in the standby or off mode?</li> </ul>	<ul style="list-style-type: none"> <li>• Operate the computer (move the mouse, etc.).</li> </ul>
Part of picture is cut off or picture is not centered.	<ul style="list-style-type: none"> <li>• Is the position adjustment appropriate?</li> </ul>	<ul style="list-style-type: none"> <li>• Adjust the IMAGE ADJUST properly.</li> </ul>
Image is too large or too small.	<ul style="list-style-type: none"> <li>• Is the screen size adjustment appropriate?</li> </ul>	<ul style="list-style-type: none"> <li>• Press the WIDE button on the remote control and adjust properly.</li> </ul>
Picture is unstable.	<ul style="list-style-type: none"> <li>• Is the computer's resolution setting appropriate?</li> </ul>	<ul style="list-style-type: none"> <li>• Set to the proper resolution.</li> </ul>
POWER/STANDBY indicator is lighted in red.	<ul style="list-style-type: none"> <li>• Horizontal and / or vertical sync signal is not present when the Intelligent Power Manager control is on.</li> </ul>	<ul style="list-style-type: none"> <li>• Check the input signal.</li> </ul>
POWER/STANDBY indicator is blinking in red.	<ul style="list-style-type: none"> <li>• The temperature inside the main unit has become too high and has activated the protector.</li> </ul>	<ul style="list-style-type: none"> <li>• Promptly switch off the power of the main unit and wait until the internal temperature drops. See*1.</li> </ul>
POWER/STANDBY indicator is blinking in green and red, or green.	<p style="text-align: center;">—————</p>	<ul style="list-style-type: none"> <li>• Promptly switch off the power of the main unit. See *2.</li> </ul>

**\*1 Overheat protector**

If the monitor becomes too hot, the overheat protector will be activated and the monitor will be turned off. If this happens, turn off the power to the monitor and unplug the power cord. If the room where the monitor is installed is particularly hot, move the monitor to a cooler location and wait for the monitor to cool for 60 minutes. If the problem persists, contact your dealer.

**\*2 In the following case, power off the monitor immediately and contact your dealer or authorized Service Center.**

The monitor turns off 5 seconds after powering on and then the POWER/STANDBY indicator blinks. It indicates that the power supply circuit, plasma display panel, temperature sensor, or one or more fans have been damaged.

# Specifications : PD4250D

<b>Screen Size</b>	36.1"(H) × 20.4"(V) inches 918(H) × 518(V) mm diagonal 42"
<b>Aspect Ratio</b>	16 : 9
<b>Resolution</b>	1024(H) × 768(V) pixels
<b>Pixel Pitch</b>	0.036"(H) × 0.027"(V) inches 0.897(H) × 0.675(V) mm
<b>Color Processing</b>	4,096 steps, 68.7 billion colors
<b>Signals</b>	
Synchronization Range	Horizontal : 15.5 to 110 kHz (automatic : step scan) Vertical : 50.0 to 120.0 Hz (automatic : step scan)
Input Signals	RGB, NTSC (3.58/4.43), PAL (B,G,M,N), PAL60, SECAM, HD* <sup>1</sup> , DVD* <sup>1</sup> , DTV* <sup>1</sup>
<b>Input Terminals</b>	
<b>RGB</b>	
Visual 1 (Analog)	mini D-sub 15-pin × 1
Visual 2 (Analog)	BNC (R, G, B, H/CS, V) × 1* <sup>2</sup>
Visual 3 (Digital)	HDMI × 1* <sup>3</sup>
<b>Video</b>	
Visual 1	BNC × 1* <sup>2</sup>
Visual 2	RCA-pin × 1
Visual 3	S-Video: DIN 4-pin × 1
<b>DVD/HD/DTV</b>	
Visual 1	RCA-pin (Y, PB[CB], PR[CR]) × 1* <sup>1</sup>
Visual 2	BNC (Y, PB[CB], PR[CR]) × 1* <sup>1, *2</sup>
Visual 3	HDMI × 1* <sup>3</sup>
<b>Audio</b>	Stereo RCA × 3(Selectable)
<b>External Control</b>	D-sub 9-pin × 1(RS-232C)
<b>Sound output</b>	8W+8W at 6 ohm
<b>Power Supply</b>	AC100-240V 50/60Hz
<b>Current Rating</b>	5.2A (maximum)
<b>Power Consumption</b>	305W (typical)
<b>Dimensions</b>	40 (W) × 24 (H) × 3.5 (D) inches 1018 (W) × 610 (H) × 89(D) mm
<b>Weight</b>	65.0 lbs / 29.5 kg (without stand)
<b>Environmental Considerations</b>	
Operating Temperature	0°C to 40°C / 32°F to 104°F
Humidity	20 to 80% (no condensation)
Altitude	0 to 9180 feet / 0 to 2800 m
Storage Temperature	-10°C to 50°C / 14°F to 122°F
Humidity	10 to 90% (no condensation)
Altitude	0 to 9840 feet / 0 to 3000 m
<b>Front Panel User Controls</b>	Power on/off, Input source select, Volume up/down, OSM control
<b>Remote Control Functions</b>	Power on/off, Input source select, OSM control, Volume up/down, Cursor (UP, DOWN, LEFT, RIGHT), Zoom up/down, Picture control buttons
<b>OSM Functions</b>	PICTURE (PICTURE MEMORY/CONTRAST/ BRIGHTNESS/SHARPNESS/COLOR/TINT/ NR/COLOR TEMP./WHITE BALANCE/ GAMMA/LOW TONE/SET UP LEVEL/COLOR TUNE/CINEMA MODE/PICTURE MODE), AUDIO (BASS/TREBLE/BALANCE/AUDIO INPUT1/AUDIO INPUT2/AUDIO INPUT3), IMAGE ADJUST (ASPECT MODE/V- POSITION/H-POSITION/V-HEIGHT/H- WIDTH/AUTO PICTURE/FINE PICTURE/ PICTURE ADJ.), SET UP (LANGUAGE*/BNC INPUT/D-SUB INPUT/HD SELECT/RGB SELECT/HDMI SET UP/COLOR SYSTEM/BACK GROUND/GRAY LEVEL/S1/S2/DISPLAY OSM/OSM ADJ./ALL RESET), FUNCTION (POWER MGT./INPUT SKIP/PDP SAVER [PEAK BRIGHT / ORBITER / INVERSE/WHITE / SCREEN WIPER / SOFT FOCUS / OSM ORBITER / OSM CONTRAST]/ CLOSED CAPTION/CAPTION CONT), SIGNAL INFO.

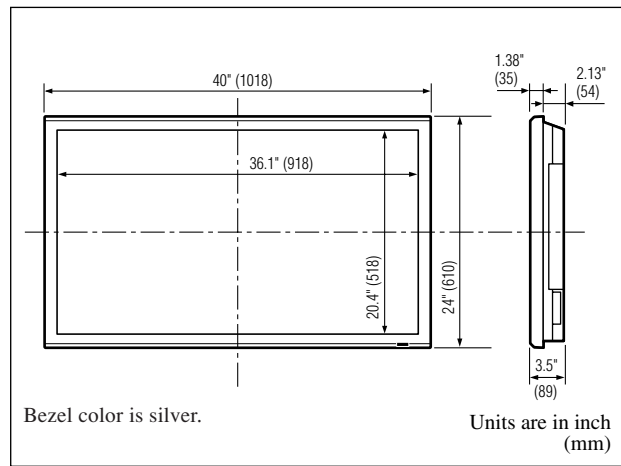

The features and specifications may be subject to change without notice.

#### \*<sup>1</sup> HD/DVD/DTV input signals supported on this system

480P (60 Hz)	480I (60 Hz)	525P (60 Hz)
525I (60 Hz)	576P (50 Hz)	576I (50 Hz)
625P (50 Hz)	625I (50 Hz)	720P (60 Hz)
1035I (60 Hz)	1080I (50 Hz)	1080I (60 Hz)

\*<sup>2</sup> The 5-BNC connectors are used as RGB/PC2 and HD/DVD2 input. Select one of them under "BNC INPUT".

\*<sup>3</sup> Compatible with HDCP.

#### Supported Signals

- 640 × 480P @ 59.94/60Hz
- 1280 × 720P @ 59.94/60Hz
- 1920 × 1080I @ 59.94/60Hz
- 720 × 480P @ 59.94/60Hz
- 1440 (720) × 480I @ 59.94/60Hz
- 1920 × 1080I @ 50Hz
- 720 × 576P @ 50Hz
- 1440 (720) × 576P @ 50Hz

**Note:** In some cases a signal on the plasma monitor may not be displayed properly. The problem may be an inconsistency with standards from the source equipment (DVD, Set-top box, etc...). If you do experience such a problem please contact your authorized Marantz dealer and also the manufacturer of the source equipment.

\*English, German, French, Italian, Spanish, Swedish, Chinese, Russian

**Other Features** Motion compensated 3D Scan Converter (NTSC, PAL, 480I, 576I, 525I, 625I, 1035I, 1080I), 2-3 pull down Converter (NTSC, 480I, 525I, 1035I, 1080I (60Hz)), 2-2 pull down Converter (PAL, 576I, 625I, NTSC, 480I, 525I), Digital Zoom Function (100-900% Selectable), Self Diagnosis, Image Burn reduction tools (PEAK BRIGHT, INVERSE, WHITE, ORBITER, SCREEN WIPER), Color Temperature select (high/middle/middle low/low, user has 4 memories), Auto Picture, Input Skip, Color Tune, Low Tone (3 mode), Gamma Correction (4 mode), Plug and play (DDC1, DDC2b, RGB3: DDC2b only)

**Accessories** Remote control with two AAA batteries, Power cord, User Guide, Safety metal fittings, Ferrite cores, Bands, Cable clamps

**Regulations** UL approved (UL60950, UL6500, CSA C22.2 No.60950-00, CAN/CSA-E60065-00) SEMKO Approved (EN60950, EN60065, IEC60950, IEC60065) Meets FCC Part 15 Class B DOC Canada requirements Meets AS/NZS CISPR 22:2002 Class B

**OPTION STAND** AS5400

# Table of Signals Supported

## ■ PD4250D Supported resolution

- When the screen mode is NORMAL, each signal is converted to a 768 dots × 768 lines signal. (Except for \*2,\*4)
- When the screen mode is FULL, each signal is converted to a 1024 dots × 768 lines signal.

### Computer input signals supported by this system

Model	Dots × lines	Vertical frequency (Hz)	Horizontal frequency (kHz)	Sync Polarity		Presence		Screen mode		RGB select*5	HDMI	Memory	
				Horizontal	Vertical	Horizontal	Vertical	NORMAL (4:3)	FULL (16:9)				
	640 × 400	70.1	31.5	NEG	NEG	YES	YES	YES*2	YES	--	NO	4	
IBM PC/AT*8 compatible computers	640 × 480	59.9	31.5	NEG	NEG	YES	YES	YES	YES	STILL	YES	5	
		72.8	37.9	NEG	NEG	YES	YES	YES	YES	--	YES	7	
		75.0	37.5	NEG	NEG	YES	YES	YES	YES	STILL	YES	8	
		85.0	43.3	NEG	NEG	YES	YES	YES	YES	--	YES	9	
		100.4	51.1	NEG	NEG	YES	YES	YES	YES	--	YES	41	
		120.4	61.3	NEG	NEG	YES	YES	YES	YES	--	YES	42	
	848 × 480	60.0	31.0	POS	POS	YES	YES	--	YES	WIDE2	YES	19	
	852 × 480*1	60.0	31.7	NEG	NEG	YES	YES	--	YES	WIDE1	YES	17	
	800 × 600	56.3	35.2	POS	POS	YES	YES	YES	YES	STILL	YES	11	
		60.3	37.9	POS	POS	YES	YES	YES	YES	STILL	YES	12	
		72.2	48.1	POS	POS	YES	YES	YES	YES	--	YES	13	
		75.0	46.9	POS	POS	YES	YES	YES	YES	--	YES	14	
		85.1	53.7	POS	POS	YES	YES	YES	YES	--	YES	15	
		99.8	63.0	POS	POS	YES	YES	YES	YES	--	YES	43	
	120.0	75.7	POS	POS	YES	YES	YES	YES	--	YES	44		
	1024 × 768	60.0	48.4	NEG	NEG	YES	YES	YES	YES*3	STILL	YES	24	
		70.1	56.5	NEG	NEG	YES	YES	YES	YES*3	--	YES	25	
		75.0	60.0	POS	POS	YES	YES	YES	YES*3	STILL	YES	26	
		85.0	68.7	POS	POS	YES	YES	YES	YES*3	--	YES	27	
		100.6	80.5	NEG	NEG	YES	YES	YES	YES*3	--	YES	45	
	1152 × 864	75.0	67.5	POS	POS	YES	YES	YES	YES	STILL	YES	51	
	1280 × 768	56.2	45.1	POS	POS	YES	YES	--	YES	WIDE1	NO	52	
		59.8	48.0	POS	NEG	YES	YES	--	YES	WIDE3	YES	80	
	1280 × 768*9	69.8	56.0	NEG	POS	YES	YES	--	YES	WIDE1	YES	66	
	1280 × 800*9	60.0	49.7	NEG	NEG	YES	YES	--	YES	WIDE1	YES	21	
	1280 × 854*9	60.0	53.1	NEG	NEG	YES	YES	--	YES	WIDE2	YES	37	
	1360 × 765	60.0	47.7	POS	POS	YES	YES	--	YES	WIDE1	NO	22	
		60.0	47.7	POS	POS	YES	YES	--	YES	WIDE1	YES	22	
	1376 × 768	59.9	48.3	NEG	POS	YES	YES	--	YES	WIDE2	YES	53	
	1280 × 1024	60.0	64.0	POS	POS	YES	YES	YES*4	YES	STILL	YES	29	
		75.0	80.0	POS	POS	YES	YES	YES*4	YES	--	YES	30	
		85.0	91.1	POS	POS	YES	YES	YES*4	YES	--	YES	40	
100.1		108.5	POS	POS	YES	YES	YES*4	YES	--	NO	47		
1680 × 1050*9	60.0	65.3	NEG	NEG	YES	YES	--	YES	WIDE4	YES	38		
1600 × 1200	60.0	75.0	POS	POS	YES	YES	YES	YES	--	YES	54		
	65.0	81.3	POS	POS	YES	YES	YES	YES	--	NO	55		
	70.0	87.5	POS	POS	YES	YES	YES	YES	--	NO	56		
	75.0	93.8	POS	POS	YES	YES	YES	YES	--	NO	57		
	85.0	106.3	POS	POS	YES	YES	--	YES	--	NO	58		
1920 × 1200*9	60.0	74.6	NEG	NEG	YES	YES	--	YES	WIDE2	--	81		
1920 × 1200RB*9	60.0	74.0	NEG	NEG	YES	YES	--	YES	WIDE3	YES	88		
Apple Macintosh*6 *8	640 × 480	66.7	35.0	Sync on G	Sync on G	--	--	YES	YES	--	NO	6	
	832 × 624	74.6	49.7	Sync on G	Sync on G	--	--	YES	YES	--	NO	16	
	1024 × 768	74.9	60.2	Sync on G	Sync on G	--	--	YES	YES*3	WIDE1	NO	28	
	1152 × 870	75.1	68.7	Sync on G	Sync on G	--	--	YES	YES	WIDE1	NO	39	
1440 × 900*9	60.0	56.0	NEG	NEG	YES	YES	--	YES	--	YES	89		
Work Station (EWS4800)*8	1280 × 1024	60.0	64.6	NEG	NEG	YES	YES	YES*4	YES	--	YES	29	
		71.2	75.1	NEG	NEG	YES	YES	YES*4	YES	--	YES	48	
Work Station (HP)*8	1280 × 1024	72.0	78.1	--	--	--	--	YES*4	YES	--	YES	59	
Work Station (SUN)*8	1152 × 900	66.0	61.8	C Sync	C Sync	--	--	YES	YES	--	YES	60	
		76.0	71.7	C Sync	C Sync	--	--	YES	YES	--	YES	61	
	1280 × 1024	76.1	81.1	C Sync	C Sync	--	--	YES*4	YES	--	YES	30	
Work Station (SGI)	1024 × 768	60.0	49.7	--	--	--	--	YES	YES*3	--	YES	62	
	1280 × 1024	60.0	63.9	--	--	--	--	YES*4	YES	--	YES	29	
IDC-3000G													
	PAL625P	768 × 576	50.0	31.4	NEG	NEG	YES	YES	YES*7	YES*7	--	NO	31
	NTSC525P	640 × 480	59.9	31.5	NEG	NEG	YES	YES	YES*7	YES*7	MOTION	NO	32

- \*1 Only when using a graphic accelerator board that is capable of displaying 852×480.
- \*2 PD4230V : Display only 400 lines with the screen center of the vertical orientation located at the center.  
 PD4250D : Display only 640 lines with the screen center of the vertical orientation located at the center.  
 PD5050D : This signal is converted to a 1024 dots × 640 lines signal.
- \*3 The picture is displayed in the original resolution. The picture will be compressed for other signals (PD4230V/PD4250D).
- \*4 PD4230V : Aspect ratio is 5:4. This signal is converted to a 600 dots×480 lines signal.  
 PD4250D : Aspect ratio is 5:4. This signal is converted to a 720 dots×768 lines signal.  
 PD5050D : The aspect ratio is 5:4. This signal is converted to a 960 dots×768 lines signal.
- \*5 Normally the RGB select mode suite for the input signals is set automatically. If the picture is not displayed properly, set the RGB mode prepared for the input signals listed in the table above.
- \*6 To connect the monitor to Macintosh computer, use the monitor adapter (D-Sub 15-pin) to your computer's video port.
- \*7 Other screen modes (ZOOM and STADIUM) are available as well.
- \*8 When viewing a moving picture at a vertical frequency greater than 65Hz, the picture may sometimes be unstable (jumpy).  
 If this occurs, please set the refresh rate of the external equipment to 60Hz.  
 To view 480I@60Hz (480 interlaced lines, 60Hz refresh rate) or 576I@50Hz (567 interlaced lines, 50Hz refresh rate) when sync polarity is "Sync on Green", set "RGB SELECT" to "MOTION".
- \*9 CVT standard compliant.

NOTE:

- While the input signals comply with the resolution listed in the table above, you may have to adjust the position and size of the picture or the fine picture because of errors in synchronization of your computer.
  - When a 1280 dots × 1024 lines signal or 1600 dots × 1200 lines signal is input to the monitor, the picture will be compressed (PD5050D).
  - PD4230V : This monitor has a resolution of 853 dots × 480 lines. It is recommended that the input signal should be VGA, wide VGA, or equivalent.  
 PD4250D : This monitor has a resolution of 1024 dots × 768 lines. It is recommended that the input signal should be XGA, wide XGA, or equivalent.  
 PD5050D : This monitor has a resolution of 1365 dots × 768 lines. It is recommended that the input signal should be XGA, wide XGA, or equivalent.
  - With digital input some signals are not accepted.
  - The sync may be disturbed when a nonstandard signal other than the aforementioned is input.
  - If you are connecting a composite sync signal, use the HD terminal.
- 
- "IBM PC/AT" and "VGA" are registered trademarks of International Business Machines, Inc. of the United States.
  - "Apple Macintosh" is a registered trademark of Apple Computer, Inc. of the United States.
  - HDMI, the HDMI logo and High-Definition Multimedia Interface are trademarks or registered trademarks of HDM2 licensing LLC.

---



---

## DECLARATION OF CONFORMITY

---



---

This device complies with Part 15 of FCC Rules. Operation is subject to the following two conditions. (1) This device may not cause harmful interference, and (2) this device must accept any interference received, including interference that may cause undesired operation.

<b>U.S. Responsible Party:</b>	<b>Marantz America, Inc.</b>
<b>Address:</b>	<b>1100 Maplewood Drive, Itasca, IL 60143, U.S.A.</b>
<b>Tel. No.:</b>	<b>630-741-0300</b>

Type of Product:	Plasma Display
Equipment Classification:	Class B Peripheral
Models:	PD4230V/UIB, PD4250D/UIB, PD5050D/UIB, PD6150D/UIB



*We hereby declare that the equipment specified above  
conforms to the technical standards as specified in the FCC Rules.*

**www.marantz.com**

You can find your nearest authorized distributor or dealer on our website.

---

<b>JAPAN</b>	Marantz Japan, Inc.	35-1 Sagami Ohno 7-Chome, Sagamihara-shi, Kanagawa 228-8505, Japan
<b>U.S.A.</b>	Marantz America, Inc.	1100 Maplewood Drive, Itasca, IL 60143, U.S.A.
<b>EUROPE</b>	Marantz Europe B.V.	P.O. Box 8744, 5605 LS Eindhoven, The Netherlands

---

**marantz**<sup>®</sup> is a registered trademark.

