

marantz®

Model SR4400 User Guide

AV Surround Receiver

ENGLISH

WARRANTY

For warranty information, contact your local Marantz distributor.

RETAIN YOUR PURCHASE RECEIPT

Your purchase receipt is your permanent record of a valuable purchase. It should be kept in a safe place to be referred to as necessary for insurance purposes or when corresponding with Marantz.

IMPORTANT

When seeking warranty service, it is the responsibility of the consumer to establish proof and date of purchase. Your purchase receipt or invoice is adequate for such proof.

FOR U.K. ONLY

This undertaking is in addition to a consumer's statutory rights and does not affect those rights in any way.

FRANÇAIS

GARANTIE

Pour des informations sur la garantie, contacter le distributeur local Marantz.

CONSERVER L'ATTESTATION D'ACHAT

L'attestation d'achat est la preuve permanente d'un achat de valeur. La conserver en lieu sûr pour s'y reporter aux fins d'obtention d'une couverture d'assurance ou dans le cadre de correspondances avec Marantz.

IMPORTANT

Pour l'obtention d'un service couvert par la garantie, il incombe au client d'établir la preuve de l'achat et d'en corroborer la date. Le reçu ou la facture constituent des preuves suffisantes.

DEUTSCH

GARANTIE

Bei Garantiefragen wenden Sie sich bitte an Ihren Marantz-Händler.

HEBEN SIE IHRE QUITTING GUT AUF

Die Quittung dient Ihnen als bleibende Unterlage für Ihren wertvollen Einkauf. Das Aufbewahren der Quittung ist wichtig, da die darin enthaltenen Angaben für Versicherungswecke oder bei Korrespondenz mit Marantz angeführt werden müssen.

WICHTIG!

Bei Garantiefragen muß der Kunde eine Kaufunterlage mit Kaufdatum vorlegen. Ihren Quittung oder Rechnung ist als Unterlage ausreichend.

NEDERLANDS

GARANTIE

Voor inlichtingen omtrent garantie dient u zich tot uw plaatselijke Marantz.

UW KWITANTIE, KASSABON E.D. BEWAREN

Uw kwitantie, kassabon e.d. vormen uw bewijs van aankoop van een waardevol artikel en dienen op een veilige plaats bewaard te worden voor evt. verwijzing bijv. in verband met verzekering of bij correspondentie met Marantz.

BELANGRIJK

Bij een evt. beroep op de garantie is het de verantwoordelijkheid van de consument een gedateerd bewijs van aankoop te tonen. Uw kassabon of factuur zijn voldoende bewijs.

ESPAÑOL

GARANTIA

Para obtener información acerca de la garantía póngase en contacto con su distribuidor Marantz.

GUARDE SU RECIBO DE COMPRA

Su recibo de compra es su prueba permanente de haber adquirido un aparato de valor. Este recibo deberá guardarlo en un lugar seguro y utilizarlo como referencia cuando tenga que hacer uso del seguro o se ponga en contacto con Marantz.

IMPORTANTE

Cuando solicite el servicio otorgado por la garantía el usuario tiene la responsabilidad de demostrar cuándo efectuó la compra. En este caso, su recibo de compra será la prueba apropiada.

ITALIANO

GARANZIA

L'apparecchio è coperto da una garanzia di buon funzionamento della durata di un anno, o del periodo previsto dalla legge, a partire dalla data di acquisto comprovata da un documento attestante il nominativo del Rivenditore e la data di vendita. La garanzia sarà prestata con la sostituzione o la riparazione gratuita delle parti difettose.

Non sono coperti da garanzia difetti derivanti da uso improprio, errata installazione, manutenzione effettuata da personale non autorizzato o, comunque, da circostanze che non possano riferirsi a difetti di funzionamento dell'apparecchio. Sono inoltre esclusi dalla garanzia gli interventi inerenti l'installazione e l'allacciamento agli impianti di alimentazione.

Gli apparecchi verranno riparati presso i nostri

Centri di Assistenza Autorizzati. Le spese ed i rischi di trasporto sono a carico del cliente.

La casa costruttrice declina ogni responsabilità per danni diretti o indiretti provocati dalla inosservanza delle prescrizioni di installazione, uso e manutenzione dettagliate nel presente manuale o per guasti dovuti ad uso continuato a fini professionali.

PORTUGUÊS

GARANTIA

Para informações sobre a garantia, contactar o distribuidor Marantz local.

GUARDAR O RECIBO DE COMPRA

O recibo é o registo permanente da compra que fez. Deve ser guardado num local seguro, para ser apresentado em questões relacionadas com o seguro ou para quando tiver de contactar a Marantz.

IMPORTANTE

Quando procurar assistência técnica ao abrigo da garantia, é da responsabilidade do consumidor estabelecer a prova e data de compra. O recibo é prova adequada.

SVENSKA

GARANTI

För information om garantin, kontakta Marantz lokalgagent.

SPAR KVITTOT

Kvittot är ett inköpsbevis på en värdefull vara. Det skall förvaras säkert och hänvisas till vid försäkringsfall eller vidkorrespondens med Marantz.

VIKTIGT

Fö att garantin skall gälla är det kundens sak att framställa bevis och datum om köpet. Kvitto eller faktura är tillräckligt bevis för detta.

DANSK

GARANTI

Henvend dem til Deres MARANTZ-forhandler angående information om garantien.

GEM DERES KVITTERING

Deres købskvittering er Deres varige bevis på et dyrt køb. Den bør gemmes godt og anvendes som bevis, hvis De vil tegne en forsikring, eller hvis De kommunikerer med Marantz.

VIGTIGT

Det påhviler forbrugeren at skaffe bevis for købet og købsdatoen, hvis han eller hun ønsker garantiservice. Deres købskvittering eller faktura er et fulgyldigt bevis herpå.

CE MARKING

- English**
The SR4400 is in conformity with the EMC directive and low-voltage directive.
- Français**
Le SR4400 est conforme à la directive EMC et à la directive sur les basses tensions.
- Deutsch**
Das Modell SR4400 entspricht den EMC-Richtlinien und den Richtlinien für Niederspannungsgeräte.
- Nederlands**
De SR4400 voldoet aan de EMC eisen en de vereisten voor laag-voltage.
- Español**
El SR4400 está de acuerdo con las normas EMC y las relacionadas con baja tensión.
- Italiano**
Il SR4400 è conforme alle direttive CEE ed a quelle per i bassi voltaggi.
- Português**
O SR4400 conforma com as diretrizes EMC e de baixa voltagem.
- Svenska**
SR4400 är tillverkad i enlighet med EMC direktiven och direktiven för lågvoltstrusning.
- Dansk**
Model SR4400 er i overensstemmelse med EMC-direktivet og direktivet om lavspænding.

English

To ventilate the unit, do not install the unit in a rack or bookshelf, and note the followings.

- Do not touch the top of the enclosure during operation.
- Do not block the openings in the enclosure during operation.
- Do not insert objects beneath the unit.
- Do not block the ventilation slots at the top of the unit.
Do not place anything about 1 meter above the top panel.
- Make a space of about 0.2 meter around the unit.

Français

Pour que l'appareil puisse être correctement ventilé, ne pas l'installer dans un meuble ou une bibliothèque et respecter ce qui suit.

- Ne pas toucher le dessus du coffret.
- Ne pas obstruer les ouïes de ventilation du coffret pendant le fonctionnement.
- Ne placer aucun objet sous l'appareil.
- Ne pas obstruer les ouïes de ventilation du panneau supérieur. Ne placer aucun objet à moins d'un mètre environ du panneau supérieur.
- Veiller à ce qu'aucun objet ne soit à moins de 0,2 mètre des côtés de l'appareil.

Deutsch

Um eine einwandfreie Belüftung des Geräts zu gewährleisten, darf das Gerät nicht in einem Gestell oder Bücherregal aufgestellt werden; die folgenden Punkte sind besonders zu beachten:

- Während des Betriebs das Oberteil des Gehäuses nicht berühren.
- Während des Betriebs die Öffnungen im Gehäuse nicht blockieren.
- Keine Gegenstände in das Gerät einführen.
- Die Belüftungsschlitze an der Oberseite des Geräts dürfen nicht blockiert werden. Darauf achten, daß über dem Gerät ein Freiraum von mindestens 1 meter vorhanden ist.
- Auf allen Geräteseiten muß ein Zwischenraum von ungefähr 0,2 meter vorhanden sein.

Nederlands

Installeer het toestel niet in een rek of boekenkast waar de ventilatie mogelijk wordt gehinderd. Let tevens op de volgende punten:

- Raak de bovenkant van het toestel niet aan als het in gebruik is.
- Blokkeer de openingen van het toestel niet als het in gebruik is.

- Plaats geen onderwerpen onder het toestel.
- Blokkeer de ventilatie-openingen aan de bovenkant van het toestel niet. Zorg dat er tenminste 1 meter vrije ruimte boven het toestel is.
- Zorg dat er 0,2 meter vrije ruimte rond het toestel is.

Español

Para ventilar la unidad no la instale en una estantería ni estante para libros, y tenga en cuenta lo siguiente:

- No toque la parte superior de la caja durante el funcionamiento.
- No tape las ranuras en la caja durante el funcionamiento
- No ponga objetos debajo de la unidad.
- No tape las ranuras de ventilación de la parte superior de la unidad. No ponga nada a menos de 1 metro por encima del panel superior.
- Deje un espacio de unos 0,2 metro alrededor de la unidad.

Italiano

Perché l'unità possa essere sempre ben ventilata, non installarla in scaffali o librerie e tenere presente quanto segue.

- Non toccare la parte superiore del rivestimento durante il funzionamento.
- Non bloccare le aperture sul rivestimento durante il funzionamento.
- Non inserire oggetti al di sotto dell'unità.
- Non bloccare le fessure di ventilazione sopra l'unità.
Non posare nulla per circa un metro sopra il pannello superiore.
- Lasciare 0,2 metro liberi tutto intorno l'unità.

Português

Para ventilar o aparelho, não instalá-lo dentro duma estante ou algo similar, e observar as seguintes recomendações:

- Não tocar a parte superior do aparelho durante a operação.
- Não bloquear as aberturas do aparelho durante a operação.
- Não inserir objectos debaixo do aparelho.
- Não bloquear as aberturas de ventilação na parte de cima do aparelho. Deixar um espaço completamente livre de cerca de 1 metro acima do painel superior.
- Deixar um espaço de cerca de 0,2 metro ao redor do aparelho.

Svenska

För att ventilera enheten, ställ den inte i ett ställ eller bokhylla och tänk på följande.

- Vidrör inte ytterhöljets ovansida under pågående drift.
- Blockera inte öppningarna i ytterhöljet under pågående drift.
- Stick inte in föremål under enheten.
- Blockera inte ventiltionshålén ovanpå enheten.
Placera inte någonting närmare än 1 meter ovanför apparaten eller enheten.
- Se till att det finns omkring 0,2 meter fri plats runt omkring enheten.

Dansk

Anbring ikke apparatet i et rack eller en boghylde, da dette kan bloke luftcirkulationen omkring apparatet. lagtag ligeledes følgende:

- Berør ikke oversiden af kabinettet under anvendelsen.
- Bloker ikke åbningerne i kabinettet under anvendelsen.
- Stik ikke genstande ind under apparatet.
- Bloker ikke ventilationsåbningerne ovenpå apparatet.
Anbring ikke noget nærmere end 1 m over apparatets overside,
- Sørg for, at der er et frit område på omkring 0,2 m omkring apparatet.

TABLE OF CONTENTS

FOREWORD	1	BASIC OPERATION (PLAY BACK) ..	21
PRECAUTIONS	1	SELECTING AN INPUT SOURCE	21
INSTALLATION	2	SELECTING THE SURROUND MODE	21
INTRODUCTION	2	ADJUSTING THE MAIN VOLUME	21
DESCRIPTION	2	ADJUSTING THE TONE (BASS & TREBLE)	
FEATURES	3	CONTROL	21
ACCESSORIES	3	TEMPORARILY TURNING OFF THE SOUND	21
FRONT PANEL	4	USING THE SLEEP TIMER	21
FL DISPLAY	4	NIGHT MODE	22
REAR PANEL	5	SURROUND MODE	22
REMOTE CONTROL OPERATION	6	OTHER FUNCTION	25
FUNCTION AND OPERATION	6	ATTENUATION TO ANALOG INPUT SIGNAL	25
PROGRAMMING THE REMOTE CONTROLLER	7	LISTENING OVER HEADPHONES	25
OPERATION OF REMOTE CONTROL UNIT	8	DIMMER (DISPLAY)	25
GENERAL INFORMATION OF RC5400SR		SELECTING ANALOG AUDIO INPUT OR	
TO SR4400	9	DIGITAL AUDIO INPUT	25
CONNECTIONS	10	RECORDING AN ANALOG SOURCE	25
SPEAKER PLACEMENT	10	HT-EQ	25
CONNECTING SPEAKERS	10	6.1 CH INPUT	25
CONNECTING AUDIO COMPONENTS	11	BASIC OPERATION (TUNER)	26
CONNECTING VIDEO COMPONENTS	12	LISTENING TO THE TUNER	26
ADVANCED CONNECTING	13	PRESET MEMORY	26
CONNECTING REMOTE CONTROL JACKS	13	RDS OPERATION	28
CONNECTING THE ANTENNA TERMINALS	14	TROUBLESHOOTING	29
SETUP	15	TECHNICAL SPECIFICATIONS	30
SETUP MENU SYSTEM	15	DIMENSION	30
ENTER THE DESIRED MENU ITEM OF			
THE SETUP MENU	15		
SIMPLE SETUP	16		
1. INPUT SETUP (ASSIGNABLE DIGITAL INPUT)	16		
2. SPEAKER SETUP	17		
3. PREFERENCE	19		
4. PL II (DOLBY PRO LOGIC II)	19		
5. CS II (CIRCLE SURROUND II)	20		
6. 6.1 CH INPUT LEVEL	20		
7. SURROUND	20		

FOREWORD

This section must be read before any connection is made to the mains supply.

WARNINGS

Do not expose the equipment to rain or moisture.

Do not remove the cover from the equipment.

Do not insert anything into the equipment through the ventilation holes.

Do not handle the mains lead with wet hands.

Do not cover the ventilation with any items such as tablecloths, newspapers, curtains, etc.

No naked flame sources, such as lighted candles, should be placed on the equipment.

When disposing of used batteries, please comply with governmental regulations or environmental public instruction's rules that apply in your country or area.

EQUIPMENT MAINS WORKING SETTING

Your Marantz product has been prepared to comply with the household power and safety requirements that exist in your area. SR4400 can be powered by 230 V AC only.

COPYRIGHT

Recording and playback of any material may require consent. For further information refer to the following:

- Copyright Act 1956
- Dramatic and Musical Performers Act 1958
- Performers Protection Acts 1963 and 1972
- any subsequent statutory enactments and orders

PRECAUTIONS

The following precautions should be taken when operating the equipment.

GENERAL PRECAUTIONS

When siting the equipment ensure that:

- the ventilation holes are not covered;
- air is allowed to circulate freely around the equipment
- it is on a vibration free-surface;
- it will not be exposed to interference from an external source;
- it will not be exposed to excessive heat, cold, moisture or dust;
- it will not be exposed to direct sunlight;
- it will not be exposed to electrostatic discharges

Never place heavy objects on the equipment. If a foreign body or water does enter the equipment, contact your nearest dealer or service center.

Do not pull out the plug by pulling on the mains lead, hold the plug.

It is advisable when leaving the house, or during a thunderstorm, to disconnect the equipment from the mains supply.

PRECAUTIONS IN CONNECTION

- Be sure to unplug the power cable from the AC outlet or turn off the POWER switch before proceeding with any connection.
- Connect one cable at a time observing the "input" and "output".
This will avoid any cross connection between channels and signal inputs and outputs.
- Insert the plugs securely. Incomplete connection may result in noise.
- Prior to connecting other audio and video equipment to the SR4400, please read their owner's manuals.

INSTALLATION

If this unit or another electronic device incorporating a microcomputer is used at the same time with the tuner or television, picture disturbance or noise may occur. In such a case, install the unit according to the following guide points.

- Separate the unit as far as possible from the television.
- Place the antenna wire for the tuner or TV apart from the power cable and audio and video connection cables of this unit.
- Since the phenomenon is likely to occur when using an indoor antenna and/or 300-ohm feeder wire, we recommend using an outdoor antenna and 75-ohm coaxial cable.

CAUTIONS ON INSTALLATION

For heat dispersal, leave at least 20 cm/8 inch of space between the top, back and sides of this unit and the wall or other components.

- Do not obstruct the ventilation holes.

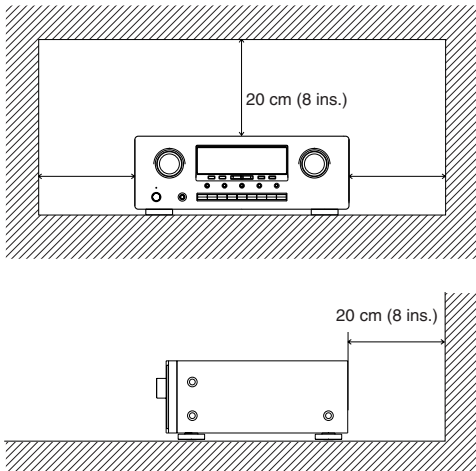

INTRODUCTION

Thank you for purchasing the Marantz SR4400 Surround receiver.

This remarkable component has been engineered to provide you with many years of home theater enjoyment. Please take a few minutes to read this manual thoroughly before you connect and operate the SR4400.

As there are a number of connection and configuration options, you are encouraged to discuss your own particular home theater setup with your Marantz A/V specialist dealer.

DESCRIPTION



DTS was introduced in 1994 to provide 5.1 channels of discrete digital audio into home theater systems.

DTS brings you premium quality discrete multi-channel digital sound to both movies and music. DTS is a multi-channel sound system designed to create full range digital sound reproduction.

The no compromise DTS digital process sets the standard of quality for cinema sound by delivering an exact copy of the studio master recordings to neighborhood and home theaters.

Now, every moviegoer can hear the sound exactly as the moviemaker intended.

DTS can be enjoyed in the home for either movies or music on of DVD's, LD's, and CD's.

"DTS" and "DTS Digital Surround" are registered trademarks of Digital Theater Systems, Inc.



The advantages of discrete multichannel systems over matrix are well known.

But even in homes equipped for discrete multichannel, there remains a need for high-quality matrix decoding. This is because of the large library of matrix surround motion pictures available on disc and on VHS tape; and analog television broadcasts.

The typical matrix decoder of today derives a center channel and a mono surround channel from two-channel matrix stereo material. It is better than a simple matrix in that it includes steering logic to improve

separation, but because of its mono, band-limited surround it can be disappointing to users accustomed to discrete multichannel.

Neo:6 offers several important improvements as follow,

- Neo:6 provides up to six full-band channels of matrix decoding from stereo matrix material. Users with 6.1 and 5.1 systems will derive six and five separate channels, respectively, corresponding to the standard home-theater speaker layouts.
- Neo:6 technology allows various sound elements within a channel or channels to be steered separately, and in a way which follows naturally from the original presentation.
- Neo:6 offers a music mode to expand stereo nonmatrix recordings into the five- or six-channel layout, in a way which does not diminish the subtlety and integrity of the original stereo recording.



DTS-ES Extended Surround is a new multi-channel digital signal format developed by Digital Theater Systems Inc. While offering high compatibility with the conventional DTS Digital Surround format, DTS-ES Extended Surround greatly improves the 360-degree surround impression and space expression thanks to further expanded surround signals. This format has been used professionally in movie theaters since 1999.

In addition to the 5.1 surround channels (FL, FR, C, SL, SR and LFE), DTS-ES Extended Surround also offers the SB (Surround Back) channel for surround playback with a total of 6.1 channels. DTS-ES Extended Surround includes two signal formats with different surround signal recording methods, as DTS-ES Discrete 6.1 and DTS-ES Matrix 6.1.

"DTS", "DTS-ES Extended Surround" and "Neo:6" are trademarks of Digital Theater Systems, Inc.



Dolby Digital identifies the use of Dolby Digital (AC-3) audio coding for such consumer formats as DVD and DTV. As with film sound, Dolby Digital can provide up to five full-range channels for left, center, and right screen channels, independent left and right surround channels, and a sixth (".1")

channel for low-frequency effects.

Dolby Surround Pro Logic II is an improved matrix decoding technology that provides better spatiality and directionality on Dolby Surround program material; provides a convincing three-dimensional soundfield on conventional stereo music recordings; and is ideally suited to bring the surround experience to automotive sound. While conventional surround programming is fully compatible with Dolby Surround Pro Logic II decoders, soundtracks will be able to be encoded specifically to take full advantage of Pro Logic II playback, including separate left and right surround channels. (Such material is also compatible with conventional Pro Logic decoders.)

Dolby Digital EX creates six full-bandwidth output channels from 5.1-channel sources. This is done using a matrix decoder that derives three surround channels from the two in the original recording. For best results, Dolby Digital EX should be used with movies soundtracks recorded with Dolby Digital Surround EX.

Manufactured under license from Dolby Laboratories. "Dolby", "Pro Logic", and the double-D symbol are trademarks of Dolby Laboratories.



Circle Surround II (CS-II) is a powerful and versatile multi-channel technology. CS-II is designed to enable up to 6.1 multi-channel surround sound playback from mono, stereo, CS encoded sources and other matrix encoded sources. In all cases the decoder extends it into 6 channels of surround audio and a LFE/subwoofer signal. The CS-II decoder creates a listening environment that places the listener "inside" music performances and dramatically improves both hi-fi audio conventional surround-encoded video material. CS-II provides composite stereo rear channels to greatly improve separation and image positioning – adding a heightened sense of realism to both audio and A/V productions.

CS-II is packed with other useful feature like dialog clarity (SRS Dialog) for movies and cinema-like bass enrichment (TruBass). CS-II can enable the dialog to become clearer and more discernable in movies and it enables the bass frequencies contained in the original programming to more closely achieve low frequencies – overcoming the low frequency

limitations of the speakers by full octave.

SRS Circle Surround II, SRS Dialog, SRS TruBass, SRS and (●)® symbol are trademarks of SRS Labs, Inc.

SRS Circle Surround II, SRS Dialog and SRS TruBass technology are incorporated under license from SRS Labs, Inc.

FEATURES

BUILT-IN 6 CHANNEL POWER AMPLIFIER

80 watts to each of the six main channels ; the power amp section features an advanced, premium high- storage power supply capacitors, and fully discrete output stages housed in cast aluminum heat sinks.

All channels are equipped the large size screw type speaker terminals.

96 kHz/24-BIT D/A CONVERTER FOR ALL CHANNELS

High performance digital circuitry with 96 kHz / 24-bit D/A converter for all 7 channels.

SIMPLE SETUP FUNCTION

This unit has Simple Setup function for easy setup. You can setup all speaker settings by just selecting your room size and the number of your speakers with Simple Setup function. You can also setup customized settings just like conventional AV amplifiers.

DTS-ES

DTS-ES decoder built in to decode the impeccable 6.1-channel discrete digital audio from DTS-ES encoded DVD-Video discs, DVD-Audio discs and CDs.

DOLBY DIGITAL EX

Dolby Digital EX decoder built in to create six full-band width output channels from the 5.1-channel digital audio of DVDs, Digital TV, HDTV, satellite broadcasts and other sources.

DOLBY PRO LOGIC II

Dolby Pro Logic II decoder provides better spatiality and directionality on Dolby Surround program material and provides a convincing three-dimensional sound field on conventional stereo music recordings.

DTS-NEO:6

DTS-Neo:6 decoder built in to decode 6.1-channel surround sound from any stereo material.

CIRCLE SURROUND II

CIRCLE SURROUND II decoder built in to decode 6.1-channel surround sound from any stereo or passive matrix-encoded material.

SOURCE DIRECT MODE

Source Direct mode bypasses, tone controls and bass management for purest audio quality.

HT-EQ (HOME THEATER EQUALIZER) EQUIPPED

In a theater, center speaker is set behind the screen and it attenuates high frequency sound so high tone is recorded emphasized. This unit has HT-EQ (Home Theater Equalizer) function. It enables to play a movie in your home just like its creator wanted.

6.1 CHANNEL PRE-AMP OUTPUTS

6.1 channel pre-amp outputs for connection to external components such as a subwoofer and external power amplifiers.

6.1CH DIRECT INPUT

6.1ch direct inputs accommodate future multi-channel sound formats or an external digital decoder. (SACD, DVD-Audio, ...etc)

4 DIGITAL INPUTS AND 2 DIGITAL OUTPUTS

4 Digital inputs for connection to other sources, such as DVD player, Satellite tuner, CD player, CD recorder or MD deck.

2 Digital outputs for connection to CD recorder or MD deck.

30 STATION RANDOM ACCESS PRESET TUNING

High-quality AM/FM tuner with 30 station random access preset tuning.

RDS FUNCTION

Radio Data System(RDS) provides information on FM broadcasts.

ACCESSORIES

Remote Controller RC5400SR

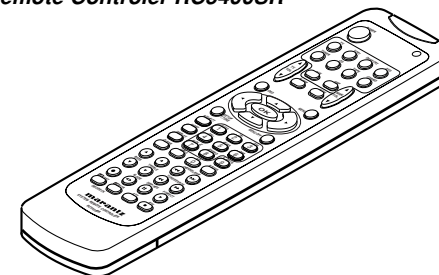

AAA-size batteries X 2

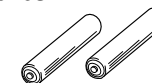

AM Loop Antenna

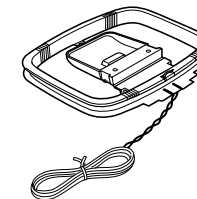

FM Antenna

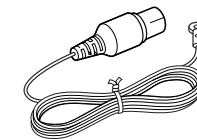

AC Power Cord

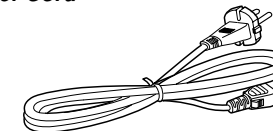

Registration Card User Guide

FRONT PANEL

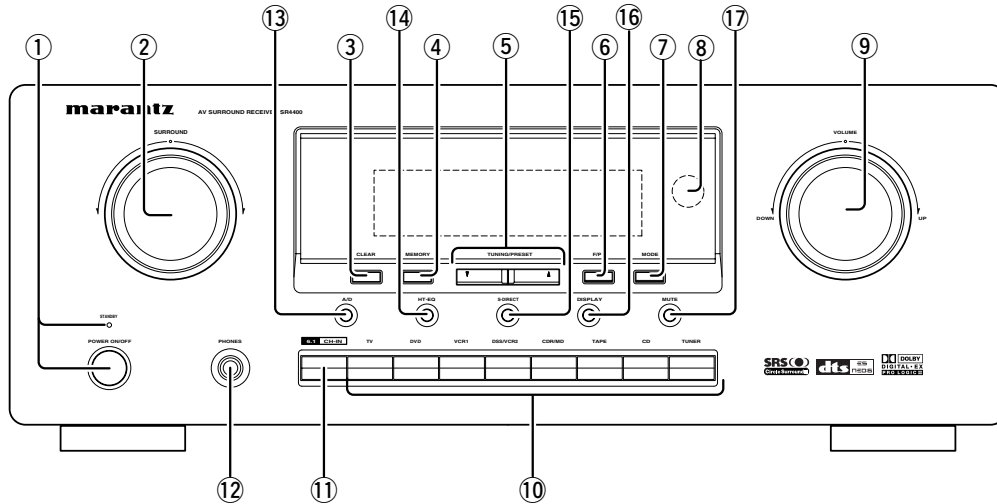

① POWER switch and STANDBY indicator

Press the button to turn the power ON, and press again to turn it OFF. If the **POWER** switch is in the ON position, the power of this unit can be turned ON/OFF by pressing the **POWER** button on the remote control unit.

When this unit is in the standby mode with the **POWER** switch set to the ON position, pressing one of the **FUNCTION SELECTOR** buttons also allows to turn the power on.

The **STANDBY** indicator lights up when this unit is the standby mode (power OFF) by the remote control unit.

② SURROUND MODE Selector knob

When this knob is turned, the surround mode is switched sequentially.

Note:

- Available surround mode is depending on the input signal.

③ CLEAR button

Press this button to cancel the station-memory setting mode or preset scan tuning.

④ MEMORY button

Press this button to enter the tuner preset memory numbers or station names.

⑤ TUNING UP / DOWN buttons

Press these buttons to change the frequency or the preset number.

⑥ F/P (FREQUENCY / PRESET) button

During reception of AM or FM, you can change the function of the UP/DOWN buttons for scanning frequencies or selecting preset stations by pressing this button.

⑦ MODE button

Press this button to select the auto stereo mode or mono mode when the FM band is selected.

The **"AUTO"** indicator lights in the auto stereo mode.

⑧ Infrared receiving (IR) sensor window

This window receives infrared signals for the remote control unit.

⑨ VOLUME control knob

Adjusts the overall sound level. Turning the control clockwise increases the sound level.

⑩ INPUT FUNCTION SELECTOR buttons (AUDIO/ VIDEO)

These buttons are used to select the input sources.

The video function selector, such as TV, DVD, VCR1 and DSS/VCR2, selects video and audio simultaneously.

Audio function sources such as CD, TAPE, CDR/MD, TUNER, and 6.1CH-IN may be selected in conjunction with a Video source.

This feature (Sound Injection) combines a sound from one source with a picture from another.

Choose the video source first, and then choose a different audio source to activate this function.

Press **TUNER** button to switch the between FM or AM.

⑪ 6.1CH IN button

Press this button to select the output of an external multi channel decoder.

Press this button again to return the previous function.

⑫ PHONES jack for stereo headphones

This jack may be used to listen to the SR4400's output through a pair of headphones. Be certain that the headphones have a standard 1 / 4" stereo phone plug. Note that the speakers will automatically be turned off when the headphone jack is in use.

Notes:

- When using headphones, the surround mode will automatically change to STEREO.
- The surround mode returns to the previous setting as soon as the plug is removed from the jack.

⑬ A/D (Analog/Digital) SELECTOR button

This is used to select between the analog and digital inputs.

Note:

- This button is not used for an input source that is not set to a digital input in the system setup menu.

⑭ HT-EQ button

Used to turn on or off HT (Home Theater)-EQ mode when the surround mode is set as AUTO, DOLBY, DTS or STEREO.

This mode compensates for the audio portion of a movie sounding "bright". When this button is pressed, "EQ" indicator lights up.

⑮ S- (Source) DIRECT button

When this button is pressed, the tone control circuitry is bypassed as well as Bass Management.

Notes:

- The surround mode is automatically switched to AUTO when the source direct function is turned on.
- S-DIRECT is turned off when the other surround mode is selected with the SURROUND mode selector knob or the surround mode buttons of the remote controller.
- Additionally, Speaker Configurations are fixed automatically as follow.
(Front SPKR = Large, Center SPKR = Large, Surround SPKR = Large, Sub woofer = On)

⑯ DISPLAY button

When this button is pressed once, the display is dimmed.

When this button is pressed twice, the display is turned off and "DISP" indicator lights up.

Press this button again to turn the display ON again.

⑰ MUTE button

Press this button to mute the output to the speakers and headphones. Press it again to return to the previous volume level.

FL DISPLAY

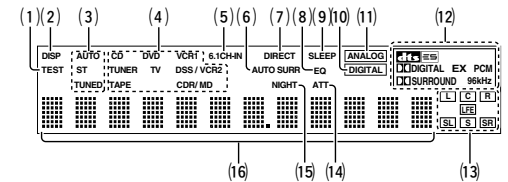

(1) TEST tone indicator

This indicator blinks in generating the test tone in speaker level setup.

(2) DISP (Display Off) indicator

This indicator lights when the SR4400 is in the display off condition.

(3) TUNER's indicators

AUTO : This indicator illuminates when the tuner's Auto mode is in use.

ST(Stereo) : This indicator illuminates when an FM station is being tuned in stereo condition.

TUNED : This indicator illuminates when a station is being received with sufficient signal strength to provide acceptable listening quality.

(4) INPUT SOURCE indicators

These indicators show the current input source.

(5) 6.1 CHANNEL DIRECT IN indicator

This indicator lights up when the 6.1CH-IN has been selected as a input source.

(6) AUTO.SURR (Auto Surround mode) indicator.

This indicator illuminates to show that the AUTO SURROUND mode is in use.

(7) DIRECT (Source direct) indicator

This indicator lights when the SR4400 is in the SOURCE DIRECT mode.

(8) EQ mode indicator

This indicator lights when the HT-EQ function is active.

(9) SLEEP timer indicator

This indicator lights when the seep timer function is in use.

(10) DIGITAL Input Indicator

This indicator lights when digital input has been selected.

(11) ANALOG input indicator

This indicator lights when an analog input source has been selected.

(12) SIGNAL FORMAT indicators

DIGITAL, EX, SURROUND, dts, ES, PCM and 96kHz

When the selected input is a digital source, some of these indicators will light to display the specific type of signal in use.

(13) ENCODED CHANNEL STATUS indicators

These indicators display the channels that are encoded with a digital input signal. If the selected digital input signal is Dolby Digital 5.1ch or DTS 5.1ch, "L", "C", "R", "SL", "SR" and "LFE" will light up. If the digital input signal is 2 channel PCM-audio, "L" and "R" will be displayed.

If Dolby Digital 5.1ch signal with Surround EX flag or DTS-ES signal comes in, "L", "C", "R", "SL", "S", "SR" and "LFE" will show.

(14) ATT (Attenuation) indicator

This indicator lights when the attenuation function is active.

(15) NIGHT mode indicator

This indicator lights when the SR4400 is in the Night mode, which reduces the dynamic range of digital program material at low volume levels.

(16) Main Information Display

This display shows messages relating to the status, surround mode, tuner, volume level or other aspects of unit's operation.

REAR PANEL

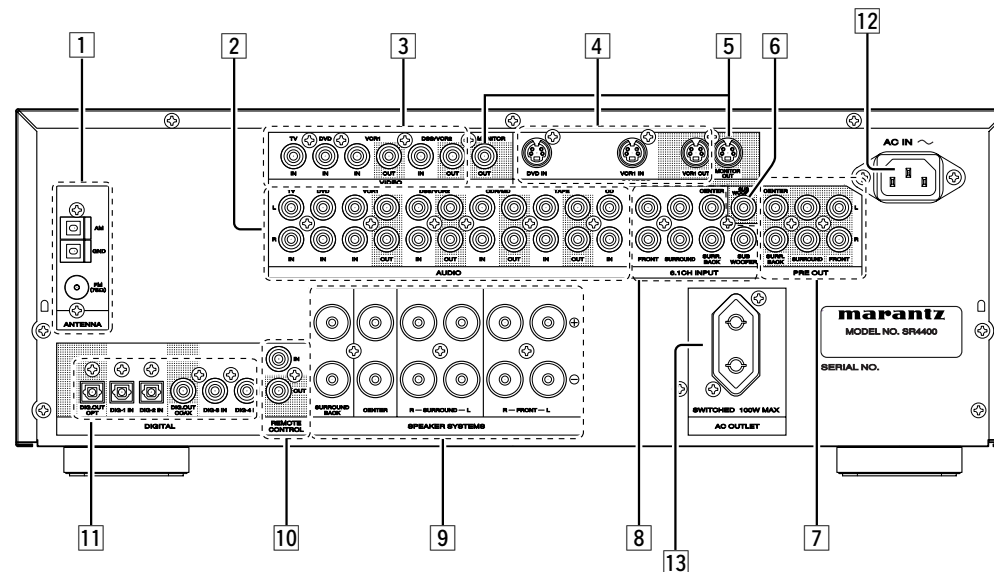

1 FM antenna terminal (75 ohms)

Connect an external FM antenna with a coaxial cable, or a cable network FM source.

AM antenna and ground terminals

Connect the supplied AM loop antenna. Use the terminals marked "AM" and "GND". The supplied AM loop antenna will provide good AM reception in most areas. Position the loop antenna until you hear the best

2 AUDIO IN/OUT (CD, TAPE, CDR/MD, TV, DVD, VCR1, DSS/VCR2)

These are the analog audio inputs and outputs. There are 7 audio inputs (4 of which are linked to video inputs) and 4 audio outputs (2 of which are linked to video outputs). The audio jacks are nominally labeled for cassette tape decks, compact disc players, DVD players and etc.... The audio inputs and outputs require RCA-type connectors.

3 VIDEO IN/OUT (TV, DVD, VCR1 and DSS/VCR2)

There are 4 composite video inputs and 2 composite video outputs. Connect VCR, DVD player, and other video components to the video input.

The output channels can be used to be connected to video recorder for making recordings.

4 S-VIDEO IN/OUT

There are 2 S-VIDEO inputs and one S-VIDEO output.

Connect VCR, DVD player, and other video components to the S-VIDEO input.

The output channel can be used to be connected to video recorder for making recordings.

S-VIDEO sources can be viewed through the S-VIDEO output, and composite sources can only be viewed through the composite output.

5 MONITOR OUT

There are 2 monitor outputs and each one includes both composite video and S-video configurations.

6 Subwoofer Output

Connect this jack to the line level input of a powered subwoofer. If an external subwoofer amplifier is used, connect this jack to the subwoofer amplifier input. If you are using two subwoofers, either powered or with a 2 channel subwoofer amplifier, connect a "Y" connector to the subwoofer output jack and run one cable from it to each subwoofer amplifier.

7 Preamp Outputs (L, R, SL, SR, SB, C)

Jacks for L (front left), R (front right), C (Center), SL (surround left), SR (surround right) and SB (surround back). Use these jacks for connection to some external power amplifiers.

8 6.1 CHANNEL INPUT

By connecting a DVD Audio player, SACD multi channel player, or other component that has a multi channel port, you can playback the audio with 5.1 channel or 6.1 channel output.

9 Speaker outputs terminals

Six terminals are provided for the front left, front right, front center, surround left, surround right and surround back speakers.

10 REMOTE CONT. IN/OUT terminals

Connect to a Marantz component equipped with remote control (RC-5) terminals.

11 DIGITAL INPUT (Dig.1 - 4) / OUTPUT (coaxial, optical)

These are the digital audio inputs and outputs. There are 2 digital inputs with coaxial jacks, 2 with optical jacks.

The inputs accept digital audio signals from a compact disc, LD, DVD, or other digital source component.

For digital output, there is 1 coaxial output and 1 optical output.

The digital outputs can be connected to MD recorders, CD recorders, DAT decks, or other similar components.

12 AC INLET

Plug the supplied power cord into this AC INLET and then into the power outlet on the wall.

13 AC OUTLET

Connect the AC power cables of components such as a DVD and CD player to this outlet. SWITCHED outlet is provided.

The marked SWITCHED provides power only when the SR4400 is turned on and is useful for components which you use every time you play your system.

Cautions:

- In order to avoid potential turn-off thumps, anything plugged in here should be powered up before the SR4400 is turned on.
- The capacity of this AC outlet is 100W. Do not connect devices that consume electricity more than the capacity to this AC outlet. If total power consumption of connected devices exceeds the capacity, protection circuit shuts down the power supply.

REMOTE CONTROL OPERATION

FUNCTION AND OPERATION

The provided remote control unit is a universal remote controller. The **POWER** button, numeric buttons and control buttons are used in common across different input source components.

The input source controlled with the remote control unit changes when one of the input selector buttons is pressed.

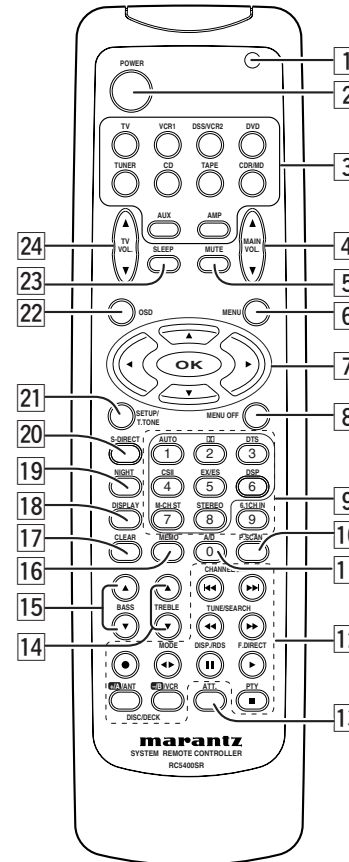

1 Transmitting indicator

Lights up during a button is pressed and an infrared signal is sending.

2 (Main) POWER buttons

Press to switch the power of the SR4400 ON or OFF after pressing the **AMP** button.

3 Input selector buttons/ FUNCTION SELECTOR buttons (AUDIO/VIDEO INPUT)

These buttons are used to select a Audio or Video source component. Press one of these buttons once to change the function of the remote control. Press same button within 2 seconds, the input function of the SR4400 is changed.

Note:

- **CDR/MD** button is set CDR function at initial. To switch MD function, press and hold down **CDR/MD** button and press **2** button.
- To return CDR function, press and hold down **CDR/MD** button and press **1** button.
- **AUX** button is unavailable for SR4400.

4 MAIN VOLUME UP (▲) /DOWN (▼) buttons

Main volume control of the SR4400. The front, surround, center and subwoofer channel volumes controlled by these buttons simultaneously.

5 MUTE button

Muting button of the SR4400. Press this button decrease the sound temporarily. Press this button again to return to the previous sound. When this button is pressed, "MUTE" indicator lights up.

6 MENU button

This button is used to enter the SETUP MAIN MENU.

7 Cursor buttons (◀, ▶, ▲, ▼, OK)

Use these button when operating the SETUP MAIN MENU. See page 15.

8 MENU OFF button

This button is used to exit from the SETUP MAIN MENU.

9 Numeric buttons 1 to 9 (A, B, C ... Z, -) / Surround mode buttons

Numeric buttons

These buttons are used to enter figures in the selection of a tuner preset station and station name preset or to set select a CD track number, etc. The functions of these buttons are dependent on the function button selected.

Surround mode buttons (when AMP mode is selected)

These buttons are used to select the surround mode.

Note:

- The surround mode is set to 6-Stereo mode by pressing **M-CH ST** button.

10 P.SCAN (preset scan) button (when TUNER mode is selected)

This button is used to start preset scan when SR4400 is selected TUNER mode.

11 0 / A/D button

0 button

This button is used to enter the number "0"

A/D button (when AMP mode is selected)

This is used to switch between the analog and digital inputs.

12 CONTROL buttons

These buttons are used when operating the CD player, TAPE deck, etc.

The function of these buttons are dependent on the function button selected.

For the controllable functions of each input function, please refer to contrable function table on the page 9.

13 ATT (attenuator) button

When the input signal is too high and the voice distorts even by throttling the SR4400 VOLUME control, turn on this function. "ATT" is indicated when this function is activated.

The input level is reduced. Attenuator is invalid for use with the output signal of "REC OUT".

Note:

- This function is unavailable during the digital input is selected.

14 TREBLE UP (▲) /DOWN (▼) buttons

These buttons are used to adjust the tone control of high frequency sound for left and right speaker.

15 BASS UP (▲) /DOWN (▼) buttons

These buttons are used to adjust the tone control of low frequency sound for left, right and subwoofer speaker.

16 MEMO button

Memory enable button for various preset functions.

17 CLEAR button

This button is used to cancel for certain memory or programming operations.

18 DISPLAY button

When this button is pressed once, the display is dimmed.

When this button is pressed twice, the display is turned off and the "DISPLAY OFF" indicator lights up.

Press this button again to turn on the display again.

19 NIGHT button

Pressing this button prevents the Dolby Digital signal from playback at a loud voice. This function reduces the voice by 1/3 to 1/4 at maximum. Thus, it eliminates the occurrence of an abruptly loud voice at night. However, the function is valid only for the case when the Dolby Digital signal is entered into OPTICAL or COAXIAL and data to compress the voice exists in the signal to be played back.

When this button is pressed, "NIGHT" indicator lights up.

20 S- (Source) DIRECT button

When this button is pressed, the tone control circuit is bypassed as well as Bass Management.

21 SETUP / T.TONE button

Test tone function is used for adjusting the balance between the volume levels of speaker channels. Press **AMP** button and press this button to enter the test tone mode.

22 OSD button

Note:

- This button is unavailable for SR4400.

23 SLEEP (sleep timer) button

This button is used for setting the sleep timer. It can be operated the same way as the button in unit.

24 TV VOLUME UP (▲) /DOWN (▼) buttons

These buttons increase or decrease TV's volume.

PROGRAMMING THE REMOTE CONTROLLER

The remote controller RC5400SR must be programmed to use the codes for your appliances of different brands. This is done by keying in a 4-digit code or by scanning the codes until the correct one is found. We recommend to using the 4-digit code. This mode is faster and more reliable. The code scanning method should be used only if you cannot find the code for one of your appliances. The codes are listed at the end of this book.

Important:

- Use the remote control buttons for programming, not the buttons of the receiver or other appliances.
- Some codes may be not match your equipment. In this case, your equipment cannot be controlled with this remote controller.

PROGRAMMING WITH THE 4-DIGIT CODE

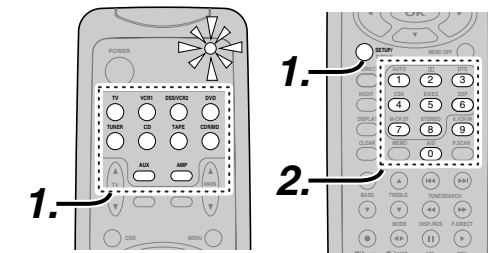

1. Press and hold down the function button for the appliance which should be controlled and press **SETUP** until the indicator blinks twice.
2. Press the 4-digit code for appliance (code table at the end of this book)
3. When the procedure is successful, the indicator will blink twice.

Note:

- If the indicator did not blink twice, then repeat steps 1 through 2 and try entering the same code again.

SCANNING THE CODE TABLE

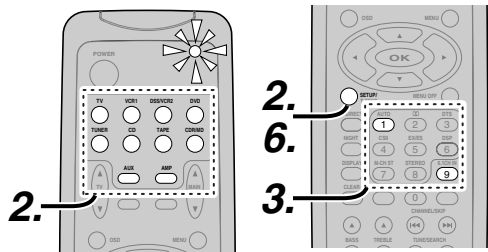

1. Switch on the appliance which should be controlled.
2. Press and hold down the function button for appliance which should be controlled and press **SETUP** until the indicator blinking twice.
3. Press the code **9 - 9 - 1**. The indicator will blink twice.
4. Aim the remote control at the appliance and slowly alternate between pressing **POWER** and the function button for the appliance.
5. Stop when the appliance turns off.
6. Press **SETUP** once to lock in the code.

CHECKING THE CODE

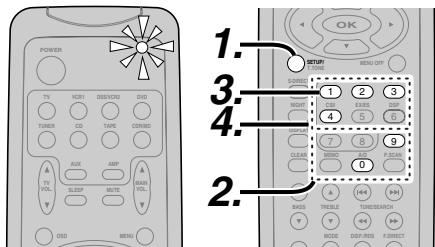

1. Press and hold down the function button for appliance which should be controlled and press **SETUP** until the indicator blinking twice.
2. Press the code **9 - 9 - 0**. The indicator will blink twice.
3. To view the code for first digit, press **1** once. Wait 3 seconds, count the indicator blinks (e.g. 3 blinks = 3) and write down the number.
Note: If a code digit is "0", the indicator will not blink.
4. Repeat step 3 three more times for remaining digits. Use **2** for the second digit, **3** for the third digit, and **4** for the fourth digit.

RESETTING THE ALL CODE

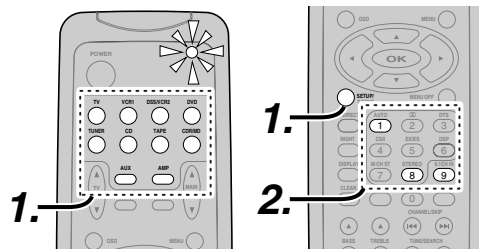

1. Press and hold down the any function button and press **SETUP** until the indicator blinking twice.
2. Press the code **9 - 8 - 1**. The indicator will blink twice. Then, RC5400SR will return to the factory preset code.

Note:

- After this procedure, the selected function button is set initial code and other function buttons are set initial code too.

Once you have found and the codes for your various appliances, you may want to write them down here.

- TV -----
- VCR -----
- DSS -----
- DVD -----
- CD -----
- TAPE -----
- CDR -----
- MD -----

OPERATION OF REMOTE CONTROL UNIT

REMOTE CONTROL

The distance between the transmitter of the remote control unit and the IR SENSOR of the SR4400 should be less than about 5 meters. If the transmitter is pointed to a direction other than the IR SENSOR or if there is an obstacle between them, remote control may not be possible.

Remote-controllable range

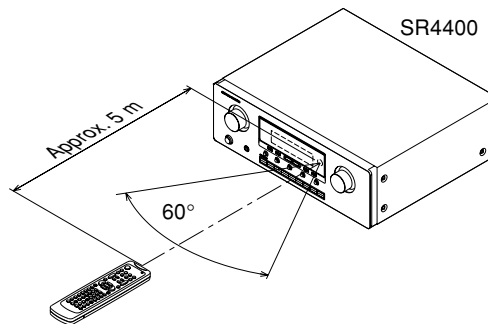

Remote control unit (RC5400SR)

LOADING BATTERIES

The life of the batteries used with the remote control unit is about 4 months with normal use. Also be sure to replace batteries earlier when you notice that they are getting weak.

1. Remove the back cover.

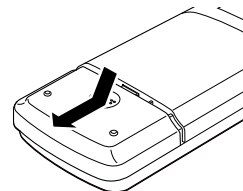

2. Insert the new batteries (AAA type) with correct \oplus and \ominus polarity.

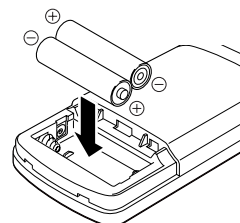

3. Close until it clicks.

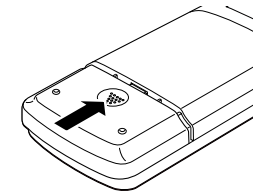

GENERAL INFORMATION OF RC5400SR TO SR4400

To control the SR4400 by your RC5400SR, you have to select the device AMP or TUNER by function selector button. Please refer as below for the details in AMP and TUNER mode.

AMP MODE

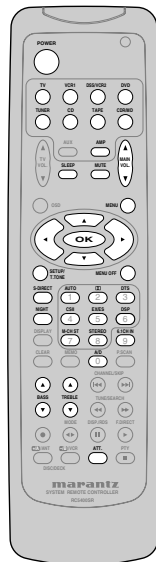

POWER	Turns the SR4400 on and off
Function selector *	Selects a particular source component AUX button is unavailable for SR4400.
SLEEP *	Sets the sleep timer function
MUTE *	Decreases the sound temporarily
VOL ▲▼*	Adjusts the over all sound level
MENU	Enters the SETUP MENU
Cursor	Moves the cursor for setting in SETUP MENU
OK	• Enters the SETUP MENU • Confirms the setting in SETUP MENU
SETUP/T.TONE	Enters the test tone mode for setting the Speaker Level Setup
MENU OFF	Exits from the SETUP MENU
S-DIRECT *	Selects the Source Direct mode
NIGHT *	Turns on or off NIGHT mode
Surround mode (1-8)	Selects the surround mode
6.1CH-IN (9)	Selects the 6.1CH IN
A/D (0)	Switches between the analog and digital inputs
BASS ▲▼*	Adjusts the tone control of low frequency sound
TREBLE ▲▼*	Adjusts the tone control of high frequency sound
ATT *	Reduces the input level

* These buttons are used to control SR4400 in any function mode.

TUNER MODE

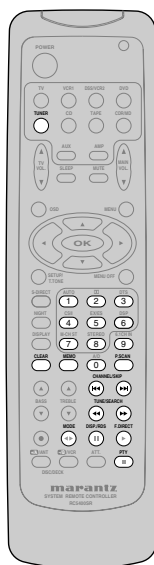

TUNER	Selects a frequency band
0-9	Inputs the numeric
CLEAR	Clears the inputting
MEMO	Enters the tuner preset memory numbers
P.SCAN	Starts preset scan
CHANNEL/SKIP	• Selects a preset station • Changes a PTY type
◀◀ / ▶▶	
TUNE/SEARCH	Tunes a station
◀◀ / ▶▶	
MODE ◀▶	Selects the auto stereo mode or mono mode
DISP./RDS ■	Selects the display mode in RDS
F.DIRECT ▶	Selects the "Frequency direct input"
PTY ■	Displays the programme type information of the current station

THE CONTRABLE FUNCTION TABLE



	TV	VCR	DVD	DSS	CD	TAPE	CDR	MD
POWER	POWER	POWER	POWER	POWER	POWER	POWER	POWER	POWER
MENU	CALL UP MENU	CALL UP MENU	CALL UP MENU	CALL UP MENU	-	-	-	-
Cursor	Cursor	Cursor	Cursor	Cursor	-	-	-	-
OK	OK	OK	OK	OK	-	-	-	-
SETUP/T.TONE	-	-	SETUP MENU	-	-	-	-	-
MENU OFF	-	CANCEL MENU	-	CANCEL MENU	-	-	-	-
0 - 9	INPUT NUMERIC	INPUT NUMERIC	INPUT NUMERIC	INPUT NUMERIC	INPUT NUMERIC	INPUT NUMERIC	INPUT NUMERIC	INPUT NUMERIC
CLEAR	INPUT CLEAR	TAPE SPEED	INPUT CLEAR	-	INPUT CLEAR	INPUT CLEAR	INPUT CLEAR	INPUT CLEAR
MEMO	-	-	CALL PROGRAM	-	CALL PROGRAM	CALL PROGRAM	-	CALL PROGRAM
CHANNEL/SKIP ◀◀	CH-	PREV	PREV	-	PREV	PREV	PREV	PREV
CHANNEL/SKIP ▶▶	CH+	NEXT	NEXT	-	NEXT	NEXT	NEXT	NEXT
TUNE/SEARCH ◀◀	-	REWIND	REWIND	-	REWIND	REWIND	REWIND	REWIND
TUNE/SEARCH ▶▶	-	FF	FF	-	FF	FF	FF	FF
● (REC)	-	REC	-	-	-	REC	REC	REC
MODE ◀▶	-	-	-	-	-	DIRECTION	-	-
DISP./RDS ■	CH DISPLAY	PAUSE	PAUSE	-	PAUSE	PAUSE	PAUSE	PAUSE
F.DIRECT ▶	-	PLAY	PLAY	-	PLAY	PLAY	PLAY	PLAY
+A/ANT	VIDEO	TV/VCR	DISC+	-	DISC+	DECK A	-	-
+B/VCR	VIDEO	TV/VCR	DISC+	-	DISC-	DECK B	-	-
PTY ■	-	STOP	STOP	-	STOP	STOP	STOP	STOP

CONNECTIONS

SPEAKER PLACEMENT

The ideal surround speaker system for this unit is 7-speaker systems, using front left and right speakers, a center speaker, surround left and right speakers, a surround back and a subwoofer. For best results we recommend that all front speakers be of the same type, with identical or similar driver units. This will deliver smooth pans across the front sound stage as the action moves from side to side.

Your center channel speaker is very important as over 80 % of the dialog from a typical motion picture emanates from the center channel.

It should possess similar sonic characteristics to the main speakers. Surround channel speakers need not be identical to the front channel speakers, but they should be of high quality.

The surround center speaker is useful for playback of Dolby Digital Surround EX or DTS-ES. One of the benefits of both Dolby Digital (AC-3) and DTS is that surround channels are discrete full range, while they were frequency limited in earlier "Pro Logic" type systems.

Bass effects are an important part of home theater. Bass effects are an important part of home theater. For optimal enjoyment a subwoofer should be used as it is optimized for low frequency reproduction. If you have full range front speakers, however, they may be used in place of a subwoofer with proper setting of the switches in the menu system.

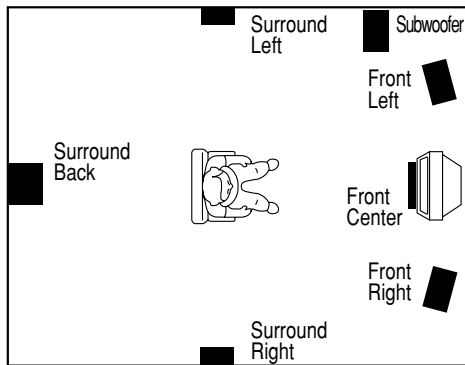

Front left and right speakers

We recommend to set the front L and R speakers with 45-60 degrees from the listening position.

Center speaker

Align the front line of the center speaker with the front L/R speakers. Or place the center speaker a little backward from the line.

Surround left and right speakers

Place the speakers right beside of the listening position or a little forward. Do not place the speakers backward of the listening position.

Surround back speaker

Place the speaker behind of the listening position.

Subwoofer

We recommend to use a sub-woofer to have maximum bass effect. Sub-woofer bears only low frequency range so you can place it anywhere in the room.

HEIGHT OF THE SPEAKER UNITS

Front left and right speakers, and a center speaker

Align the tweeters and mid-range drivers on the three front speakers on the same height as well as possible.

Surround left and right speakers, and surround back speaker

Place the surround left, right and surround back speakers higher to your ears (70cm – 1m). Also place the speakers on the same height.

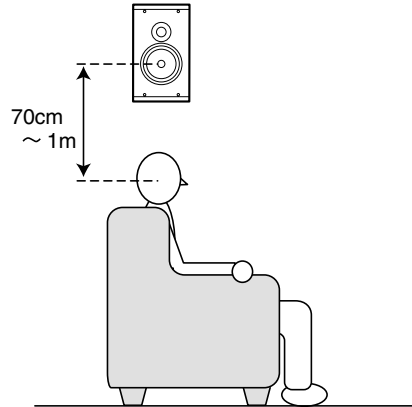

Note:

- Use magnetically-shielded speakers for front left, right and the center speakers when the speakers are installed near the TV and the TV is a monitor type.

CONNECTING SPEAKERS

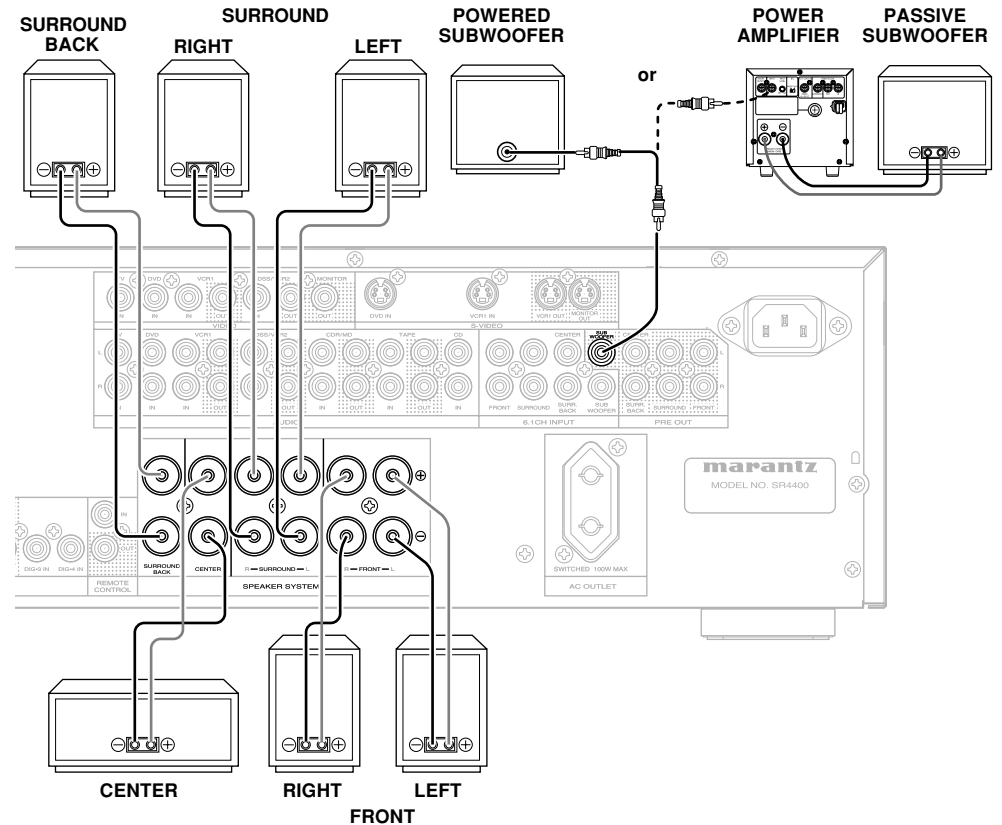

CONNECTING SPEAKER WIRE

1. Strip away approx. 10 mm of wire insulation.
2. Twist the bared wire ends tight to prevent short circuits.
3. Loosen the knob by turning counterclockwise.
4. Insert the bare part of the wire into the hole in the side of each terminal.
5. Tighten the knob by turning clockwise to secure the wire.

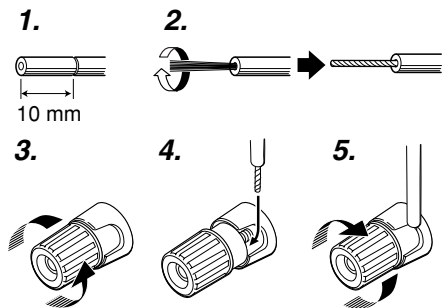

Cautions:

- Be sure to use speakers with the specified impedance shown on the rear panel of this unit.
- To prevent damage to circuitry, do not let the bare speaker wires touch each other and do not let them touch any metal part of this unit.
- Do not touch the speaker terminals when the power is on. It may cause electric shocks.
- Do not connect more than one speaker cable to one speaker terminal. Doing so may damage this unit.

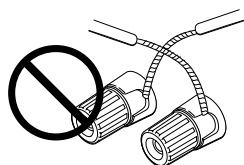

Note:

- Be sure to connect the positive and negative cables for the speaker properly. If they are misconnected, the signal phase will be reversed and the signal quality will be corrupted.

CONNECTING A SUBWOOFER

Use the PRE OUT SUBWOOFER jack to connect a powered subwoofer (power amplifier built in). If your subwoofer is passive type (power amplifier is not built in), connect a monaural power amplifier to the PRE OUT SUBWOOFER jack and connect the subwoofer to the amplifier.

CONNECTING AUDIO COMPONENTS

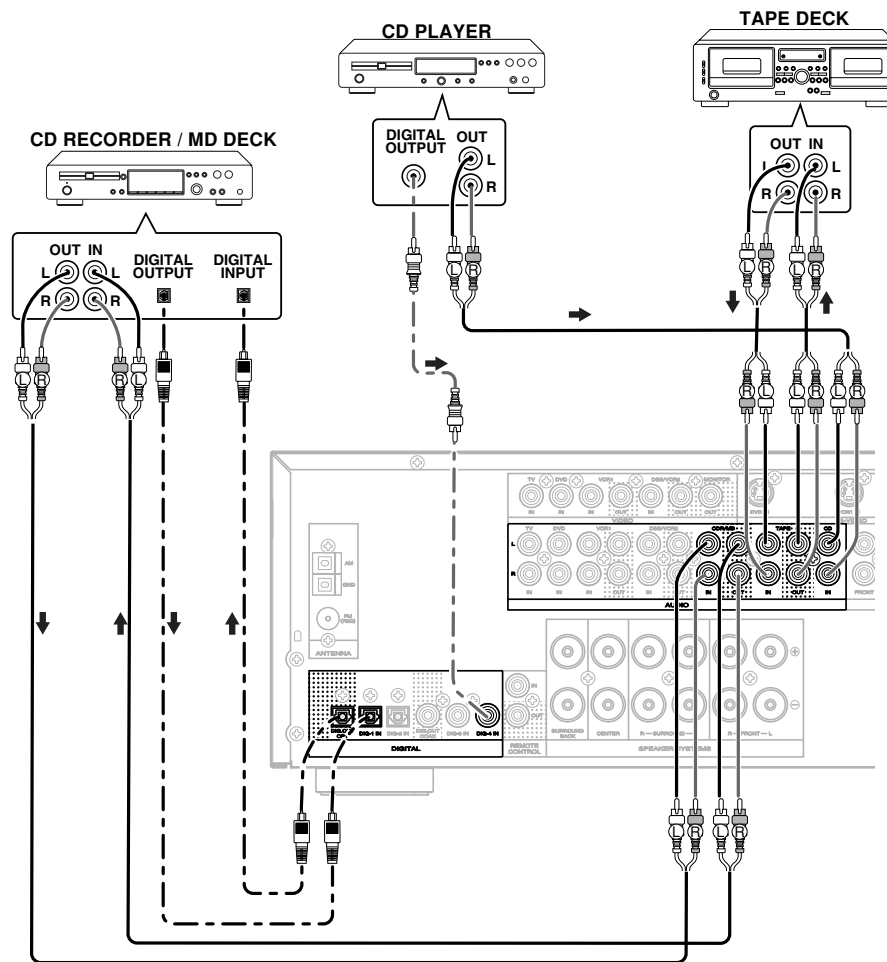

ANALOG AUDIO

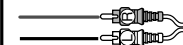

DIGITAL AUDIO (COAXIAL)



DIGITAL AUDIO (OPTICAL)



The output audio signal from the TAPE OUT jack and the CD-R/MD OUT jack is the sound source currently selected.

Caution:

- Do not connect this unit and other components to mains power until all connections between components have been completed.

Notes:

- Insert all plugs and connectors securely. Incomplete connections may make noise.
- Be sure to connect the left and right channels properly. Red connectors are for the R(right) channel, and white connectors are for the L(left) channel.
- Be sure to connect input and output properly.
- Refer to the instructions for each component that is connected with this unit.
- Do not bind audio/video connection cables with power cords and speaker cables will result in generating hum or other noise.

CONNECTING DIGITAL AUDIO COMPONENTS

- There are four digital inputs, two coaxial jacks and two optical jacks, on the rear panel. You can use these jacks to input PCM, Dolby Digital and DTS bitstream signals from a CD, DVD, or other digital source components.
- There are one digital output with coaxial jack and one with optical jack on the rear panel. These jacks can be connected to CD recorder, MD deck.
- Setup the digital audio format of DVD player, or other digital source component. Refer to the instructions for each component to be connected to digital input jacks.
- Use fiber optical cables(optical) for DIG-1,2 input jacks. Use 75 ohms coaxial cables(for digital audio or video) for DIG-3,4 input jacks.
- You can designate the input for each digital input/output jacks according to your component. See page 16.

Notes:

- There is no Dolby Digital RF input jack. Please use an external RF demodulator Dolby Digital decoder when connecting the Dolby Digital RF output jack of the video disc player to the digital input jack.
- The digital signal jacks on this unit conform to the EIA standard. If you use a cable that does not conform to this standard, this unit may not function properly.
- Each type of audio jack works independently. Signals input through the digital and analog jacks are output through the corresponding digital and analog jacks, respectively.

CONNECTING VIDEO COMPONENTS

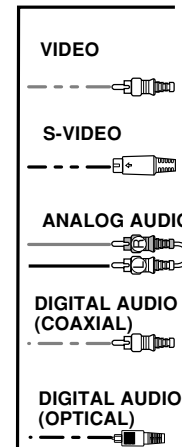
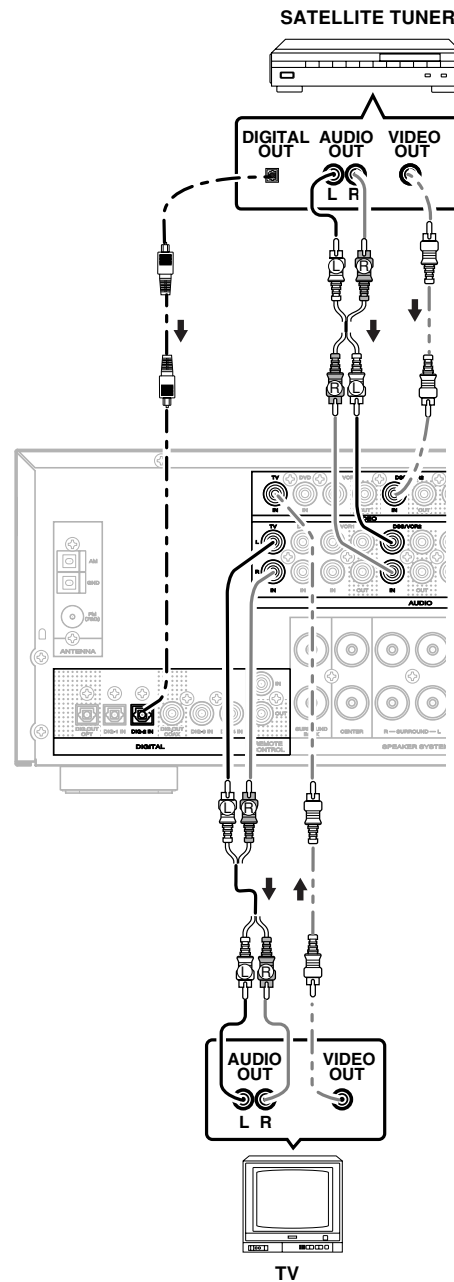
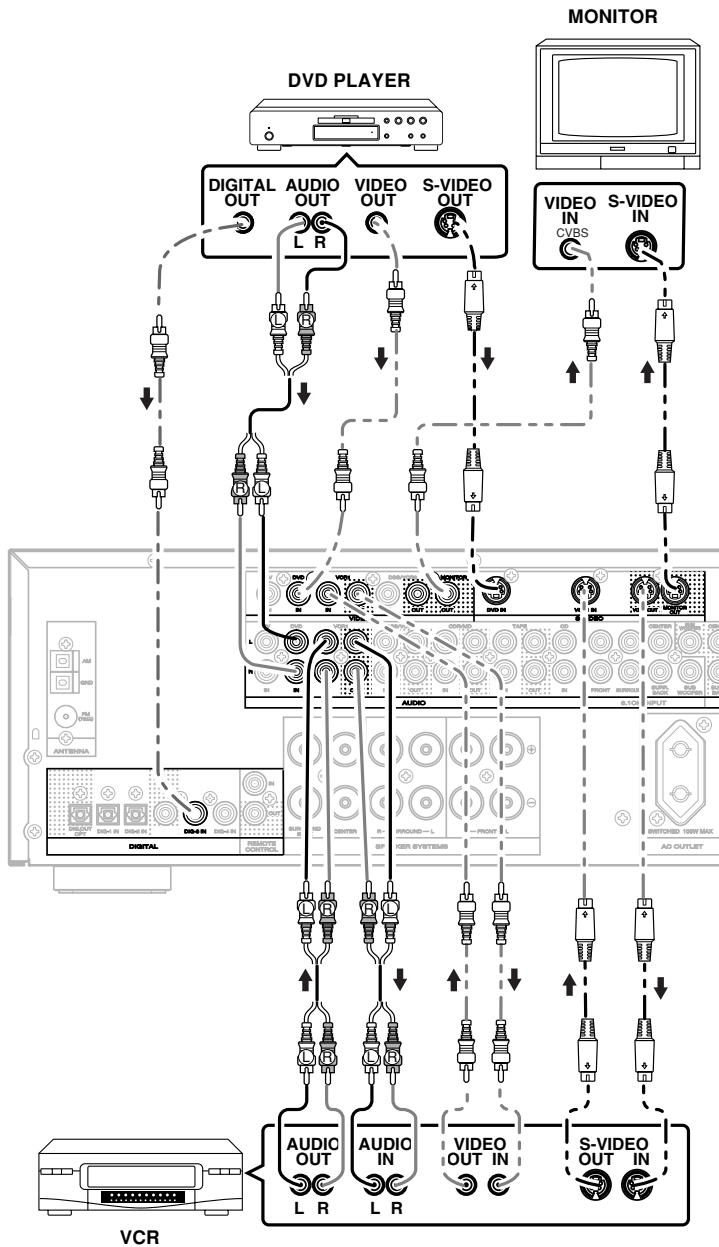

VIDEO, S-VIDEO JACKS

There are two types of video jacks on the rear panel.

VIDEO jack

The video signal for the VIDEO jacks is the conventional composite video signal.

S-VIDEO jack

The video signal is separated into luminance(Y) and color(C) signals for the S-VIDEO jack. The S-VIDEO signals enables high-quality color reproduction. If your video component has an S-VIDEO output, we recommend to use it. Connect the S-VIDEO output jack on your video component to the S-VIDEO input jack on this unit.

Notes:

- Be sure to connect the left and right audio channels properly.
Red connectors are for the R(right) channel, and white connectors are the for L(left) channel.
- Be sure to connect input and output of video signal properly.
- Each type of video jack works independently. Signals input to the VIDEO(composite) and S-VIDEO jacks are output to the corresponding VIDEO(composite) and S-VIDEO jacks, respectively.
- You may need to setup the digital audio output format of your DVD player, or other digital source component. Refer to the instructions of the each component connected to the digital input jacks.
- There is no Dolby Digital RF input jack. Please use an external RF demodulator with Dolby Digital decoder to connect a video disc player with the Dolby Digital RF output jack to the digital input jack on this unit.

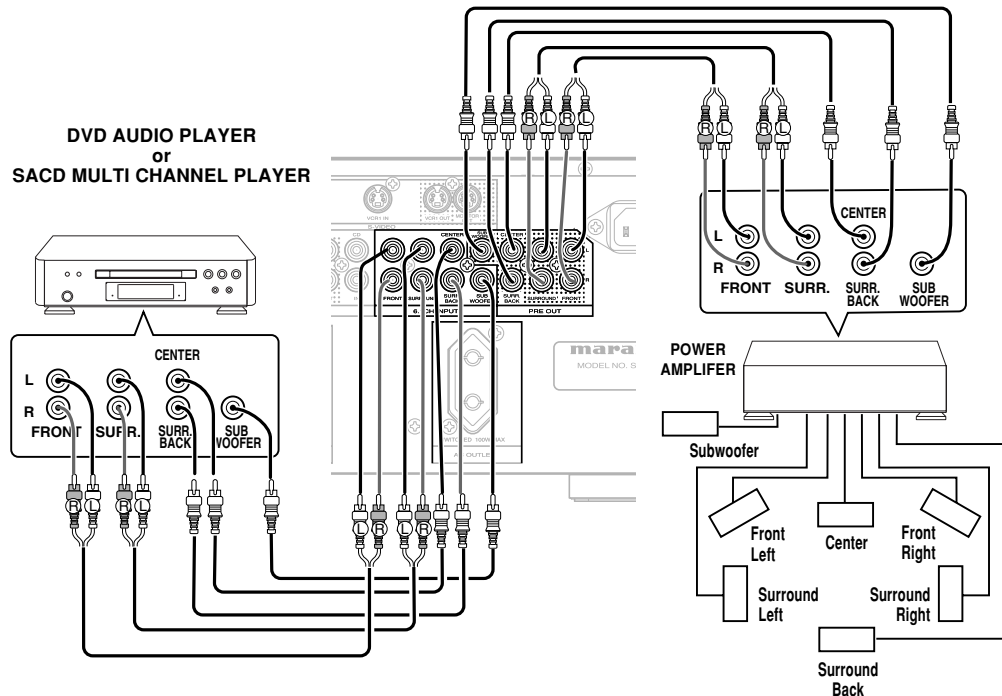

CONNECTING MULTI CHANNEL AUDIO SOURCE

The 6.1CH INPUT jacks are for multi channel audio source such as SACD multi channel player, DVD audio player or external decoder. If you use these jacks, switch on 6.1CH INPUT and setup 6.1CH INPUT level by using SETUP MAIN MENU. See page 20.

CONNECTING EXTERNAL POWER AMPLIFIER

The PREOUT jacks are for connecting external power amplifiers, you can have better sound quality. Be sure to connect each speaker to the corresponding external power amplifier.

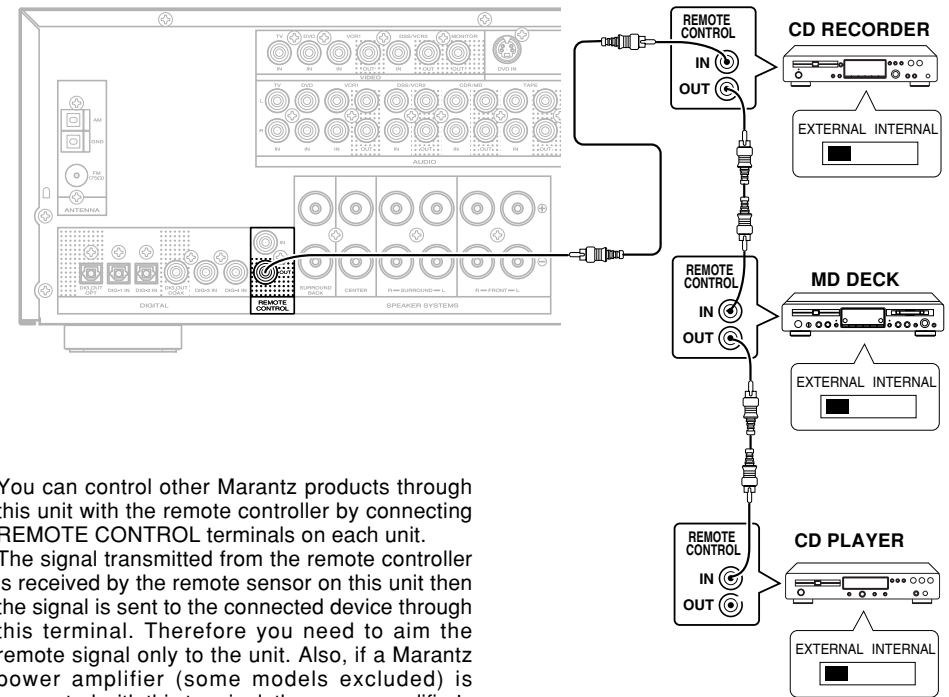

You can control other Marantz products through this unit with the remote controller by connecting REMOTE CONTROL terminals on each unit. The signal transmitted from the remote controller is received by the remote sensor on this unit then the signal is sent to the connected device through this terminal. Therefore you need to aim the remote signal only to the unit. Also, if a Marantz power amplifier (some models excluded) is connected with this terminal, the power amplifier's standby function is synchronized by pressing the POWER button on the remote.

Set the REMOTE CONTROL SWITCH on the units other than this unit to EXT.(EXTERNAL) for this feature.

CONNECTING THE ANTENNA TERMINALS

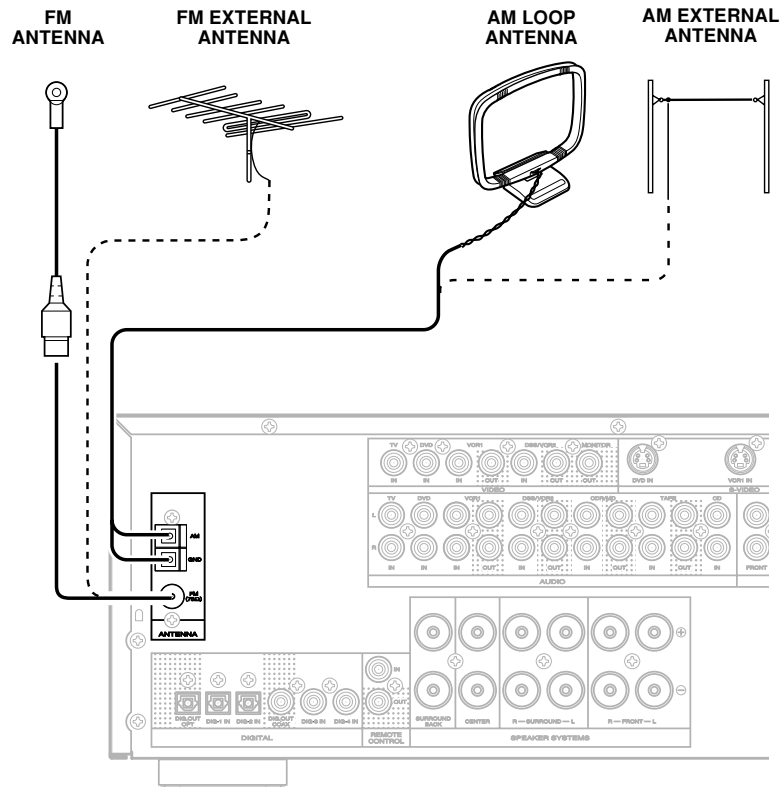

ASSEMBLING THE AM LOOP ANTENNA

1. Release the vinyl tie and take out the connection line.
2. Bend in the reverse direction.
3. Inserting into the hole to attach the loop antenna to the antenna stand.
4. With the antenna on top any stable surface.

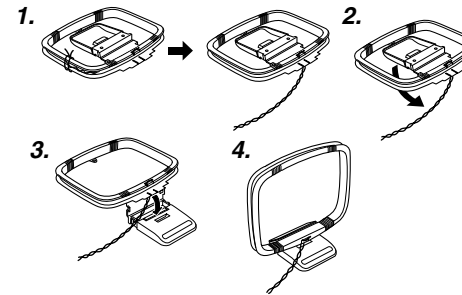

CONNECTING AN FM OUTDOOR ANTENNA

Notes:

- Keep the antenna away from noise sources (neon signs, busy roads, etc.).
- Do not put the antenna close to power lines. Keep it well away from power lines, transformers, etc.
- To avoid the risk of lightning and electrical shock, grounding is necessary.

CONNECTING AN AM OUTDOOR ANTENNA

An outdoor antenna will be more effective if it is stretched horizontally above a window or outside.

Notes:

- Do not remove the AM loop antenna.
- To avoid the risk of lightning and electrical shock, grounding is necessary.

CONNECTING THE SUPPLIED ANTENNAS

Connecting the supplied FM antenna

The supplied FM antenna is for indoor use only. During use, extend the antenna and move it in various directions until the clearest signal is received.

Fix it with push pin or similar implements in the position that will cause the least amount of distortion.

If you experience poor reception quality, an outdoor antenna may improve the quality.

Connecting the supplied AM loop antenna

The supplied AM loop antenna is for indoor use only.

Set it in the direction and position where you receive the clearest sound. Put it as far away as possible from the unit, televisions, speaker cables, and power cords.

If you experience poor reception quality, an outdoor antenna may improve the quality.

1. Press and hold down the lever of the AM antenna terminal.
2. Insert the bared wire into the antenna terminal.
3. Release the lever.

SETUP

After all components are connected, initial setup must be performed.

SETUP MENU SYSTEM

The SR4400 incorporates a menu on the front display, which makes various operations possible by using the cursor (▲, ▼, ◀, ▶) and OK buttons on the remote control.

ENTER THE DESIRED MENU ITEM OF THE SETUP MENU

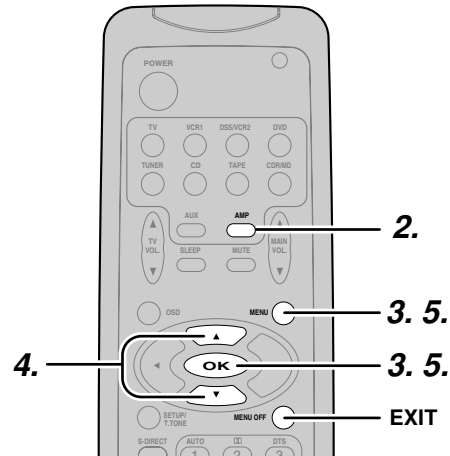

1. Turn on this unit.
2. Press the **AMP** button of the remote control to set the amp mode.
3. Press the **MENU** button or the **OK** button to enter the SETUP MENU. SIMPLE SETUP is displayed and you can enter the SIMPLE SETUP menu by pressing the **MENU** button or the **OK** button.
4. Press the ▲ or ▼ cursor button to select the MAIN MENU item.
5. Press the **OK** button or the **MENU** button to enter the desired menu item.

After finishing all setup, press the **MENU OFF** button to exit the SETUP MENU.

MENU STRUCTURE

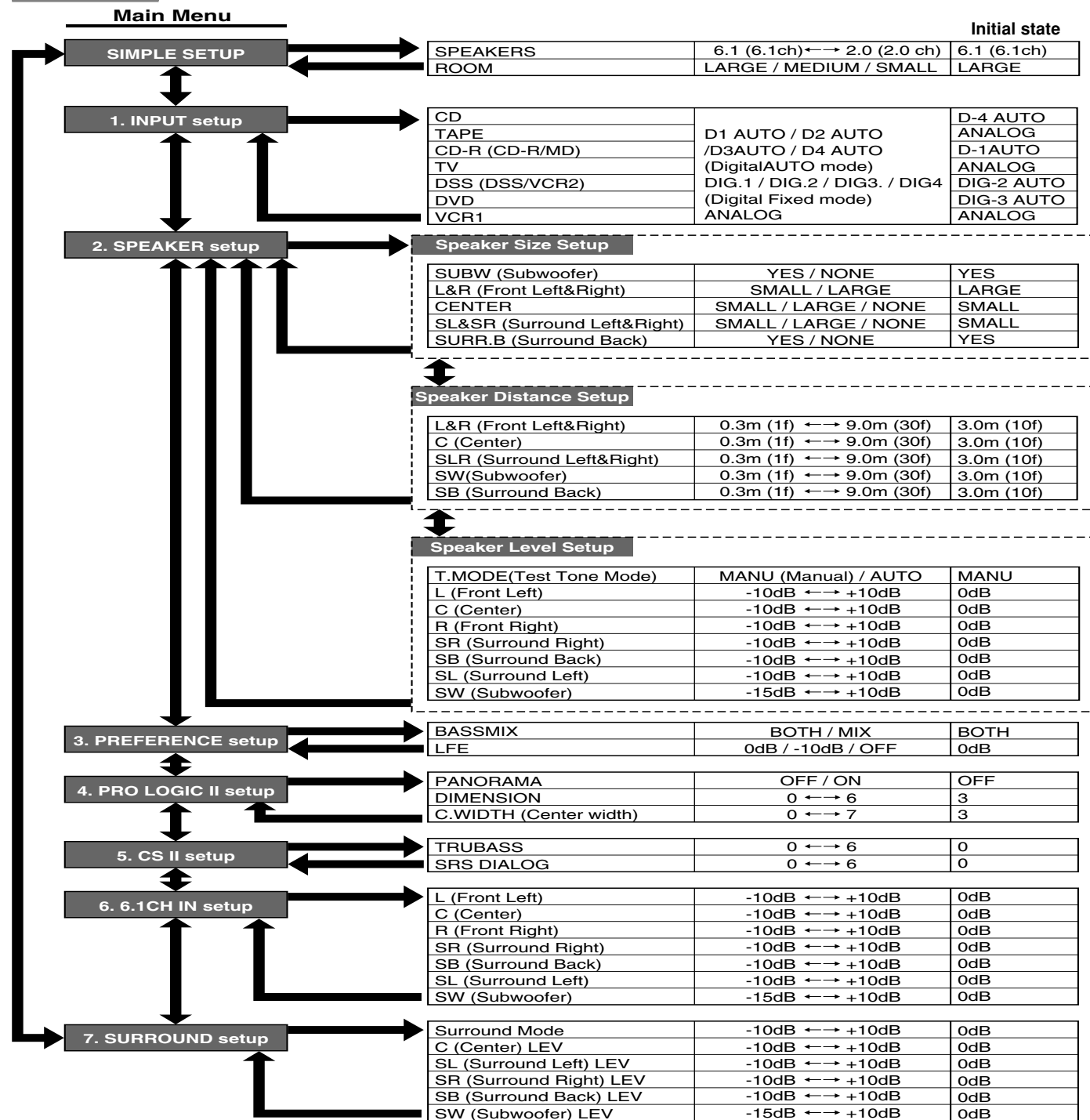

SIMPLE SETUP

You can setup the speaker conditions quickly with SIMPLE SETUP menu. In this menu, the number of speakers and speaker delay time can be set. These settings can be changed more detail in "2. SPEAKER SETUP" menu.

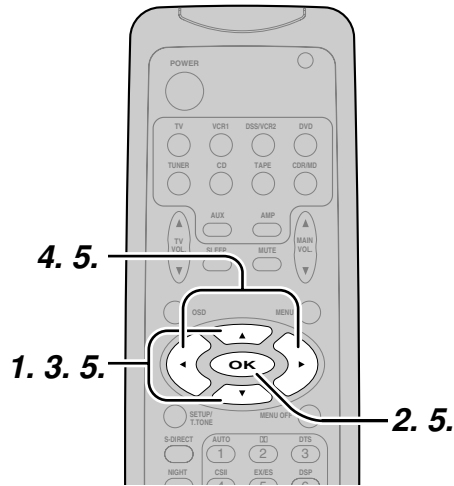

1. Select "SIMPLE SETUP" in SETUP MAIN MENU with the ▲ or ▼ cursor button.
2. Press the OK button to enter the menu.
3. Press the ▲ or ▼ cursor button to select a desired item.
4. Press ◀ or ▶ cursor button to select the speaker number or room size.
5. When you select "TO MAIN MENU" by pressing the ▲ or ▼ cursor button, you can return the SETUP MAIN MENU by pressing the OK button.
Or press the ◀ or ▶ cursor button to select "EXIT", then press the OK button to exit the SETUP MENU.

Note

- All Simple Setup menu is reset when the speaker setting is changed with Speaker Setup menu.

MENU STRUCTURE of Simple Setup

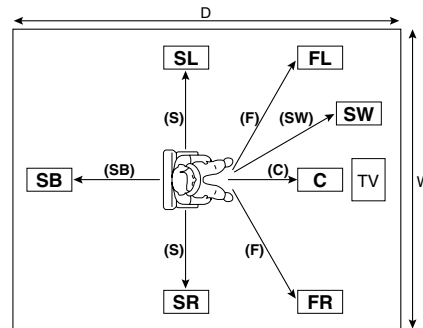
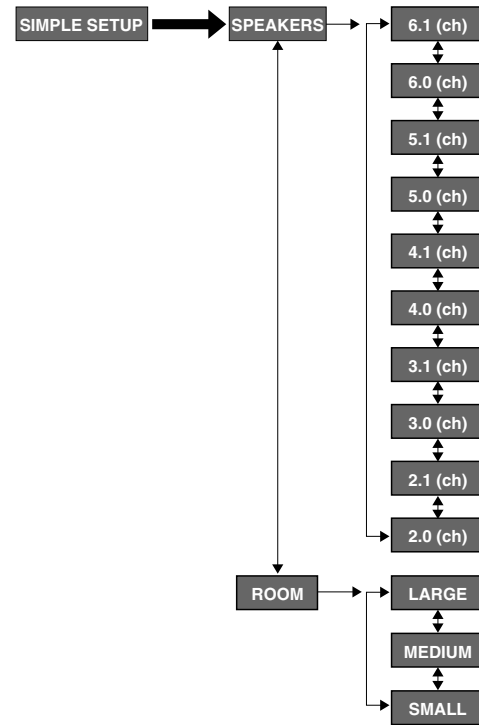

The relation of the speakers number and connected speaker

CHANNEL	Front L/R (F)	Front Center (C)	Surround L/R (S)	Surround Back (SB)	Sub woofer (SW)
6.1 ch	LARGE	SMALL	SMALL	YES	YES
6.0 ch	LARGE	SMALL	SMALL	YES	NONE
5.1 ch	LARGE	SMALL	SMALL	NONE	YES
5.0 ch	LARGE	SMALL	SMALL	NONE	NONE
4.1 ch	LARGE	NONE	SMALL	NONE	YES
4.0 ch	LARGE	NONE	SMALL	NONE	NONE
3.1 ch	LARGE	SMALL	NONE	NONE	YES
3.0 ch	LARGE	SMALL	NONE	NONE	NONE
2.1 ch	LARGE	NONE	NONE	NONE	YES
2.0 ch	LARGE	NONE	NONE	NONE	NONE

The relation of the room size and floor space

SIZE	Floor space	Width (W)	Depth (D)	Imaging Distance	
				Speaker Type	Distance
SMALL	10 m ²	2.7 m	3.6 m	Front (F)	6 ft. (1.8 m)
				Center (C)	5 ft. (1.5 m)
				Surround (S)	4 ft. (1.2 m)
				Surr. Back (SB)	5 ft. (1.5 m)
				Sub Woofer (SW)	5 ft. (1.5 m)
MEDIUM	16 m ²	3.6 m	4.5 m	Front (F)	7 ft. (2.1 m)
				Center (C)	6 ft. (1.8 m)
				Surround (S)	5 ft. (1.5 m)
				Surr. Back (SB)	7 ft. (2.1 m)
				Sub Woofer (SW)	6 ft. (1.8 m)
LARGE	24 m ²	4.5 m	5.4 m	Front (F)	9 ft. (2.7 m)
				Center (C)	8 ft. (2.4 m)
				Surround (S)	7 ft. (2.1 m)
				Surr. Back (SB)	8 ft. (2.4 m)
				Sub Woofer (SW)	8 ft. (2.4 m)

The relation of the room size and floor space is a roughly standard.

1. INPUT SETUP (ASSIGNABLE DIGITAL INPUT)

Four digital inputs can be assigned as the desired source.

Use this menu to select the digital input jack to be assigned to the input source.

The Input Setup consists of 9 items, which are as below.

• **D1AUTO to D4AUTO : Digital AUTO mode**

If the input signal from the selected source is digital signal, this unit chooses a digital input automatically.

• **DIG.1 to DIG.4 : Digital FIXED mode**

The SR4400 chooses a digital input regardless of a input signal from the selected source.

• **ANA : Analog mode**

Use this menu to select the digital input jack to be assigned to the input source.

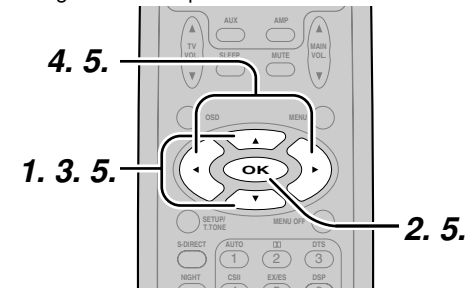

1. Select "1.INPUT" in SETUP MAIN MENU with the ▲ or ▼ cursor button.
2. Press the OK button to enter the menu.
3. Press the ▲ or ▼ cursor button to select the input source.
4. Press ◀ or ▶ cursor button to select the input function.
Select "DxAUTO", "DIG.x" or "ANA" for input sources.
5. If you finish these setup, press the ▲ or ▼ cursor button to select "TO MAIN MENU" then press the OK button to return the SETUP MAIN MENU.
Or press the ◀ or ▶ cursor button to select "EXIT" then press the OK button to exit the SETUP MENU.

Notes:

- When a DTS-LD or DTS-CD is playing, this setup is not available. This is to avoid noise being generated from the analog input.
- If “Dx-AUTO” is selected and a DVD, compact disc or LD is fast forwarded during playback, decoded signals may produce a skipping sound. In such cases, change the setting to DIGITAL.
- Same digital input function cannot be set. In this case, the previous setting is set to ANALOG. Same digital input number cannot be set in Digital AUTO mode and Digital Fixed mode. For example, D1AUTO and DIG.1 are not set at same time.

2. SPEAKER SETUP

After you have installed the SR4400, connected all the components, and determined the speaker layout, it is now time to perform the settings in the Speaker Setup menu for the optimum sound acoustics for your environment and speaker layout. Before you perform the following settings, it is important that you first determine the following characteristics:

SPEAKER SIZE

When setting the speaker size in the SPEAKER SIZE sub-menu, use the guidelines given below.

Large:

The complete frequency range for the channel you are setting will be output from the speaker.

Small:

Frequencies of the channel you are setting lower than approx. 100Hz will be output from the subwoofer.

If the Subwoofer is set to “NONE” and the front speakers are set to “Large,” then the sound may be output from both the left and right speakers.

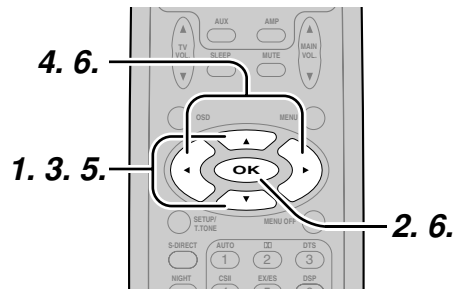

1. Select “2.SPEAKER” in SETUP MAIN MENU with ▲ or ▼ cursor button,
2. Press the **OK** button to enter the menu. The first sub-menu item is “Speaker Size” setup.
3. Press ▲ or ▼ cursor button to select the each speaker.
4. Press ◀ or ▶ cursor button to select the setting of size to each speaker.
5. If you finish these setup, press the ▲ or ▼ cursor button to select “NEXT”.
6. Press the **OK** button to enter the next “Speaker Distance” setup. Or press the ◀ or ▶ cursor button to select “EXIT” then press the **OK** button to exit the SETUP MENU. Or press the ◀ or ▶ cursor button to select “TO MAIN MENU” then press the **OK** button to return the SETUP MAIN MENU.

MENU STRUCTURE of Speaker Size setup

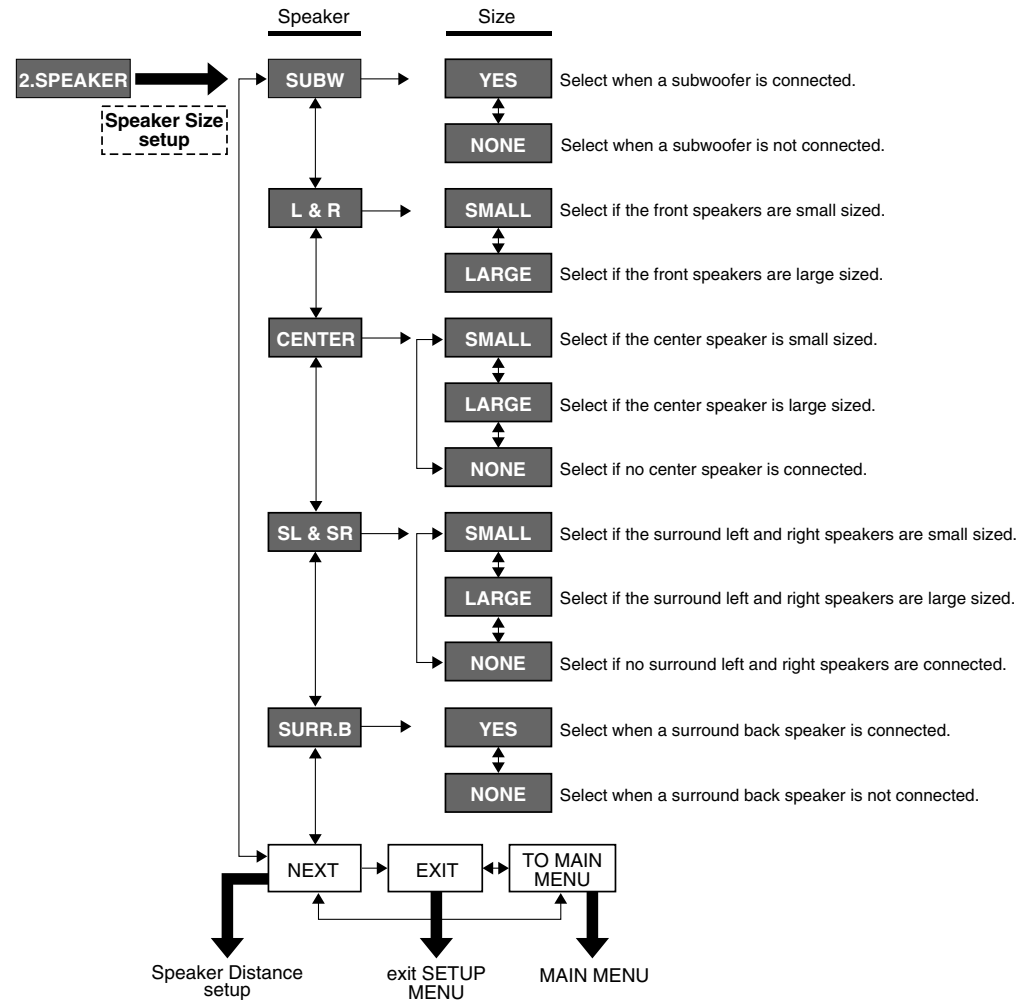

SPEAKER DISTANCE

Use this parameter to specify the distance of each speaker’s position from the listening position. The delay time is automatically calculated according to these distances.

Begin by determining the ideal or most commonly used seating position in the room.

This is important for the timing of the acoustics to create the proper sound space that the SR4400 and today’s sound systems are able to produce.

Note that the speakers that you selected “None” for in the Speaker Config sub-menu will not appear here.

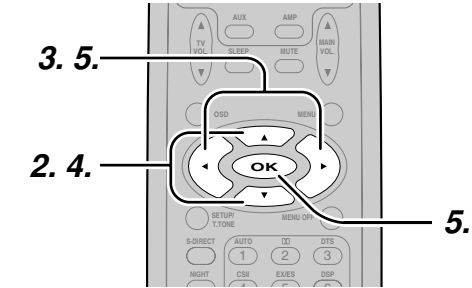

1. Enter to the “Speaker Distance setup” from the previous “Speaker Size setup”.
2. Press ▲ or ▼ cursor button to select the each speaker.
3. Press ◀ or ▶ cursor button to set the distance from your listening position for each speaker.
4. After finishing the Speaker Distance setup, press the ▲ or ▼ cursor button to select “NEXT”.
5. Press the **OK** button to enter the next “Speaker Level” setup. Or press the ◀ or ▶ cursor button to select “EXIT” then press the **OK** button to exit the SETUP MENU. Or press the ◀ or ▶ cursor button to select “TO MAIN MENU” then press the **OK** button to return the SETUP MAIN MENU. Or press the ◀ or ▶ cursor button to select “RETURN” then press the **OK** button to return the previous “Speaker Distance” setup.

L&R :
Set the distance from the front left and right speakers to your normal listening position between 1 and 30 feet in 1.0 foot interval (0.3 to 9 meters in 0.3-meter intervals).

C :
Set the distance from the center speaker to your normal listening position between 1 and 30 feet in 1.0 foot interval (0.3 to 9 meters in 0.3-meter intervals).

SLR:
Set the distance from the surround left and right speaker to your normal listening position between 1 and 30 feet in 1.0 foot interval (0.3 to 9 meters in 0.3-meter intervals).

SW :
Set the distance from the subwoofer to your normal listening position between 1 and 30 feet in 1.0-foot intervals (0.3 to 9 meters in 0.3-meter intervals).

SB:
Set the distance from a surround back speaker to your normal listening position between 1 and 30 feet in 1.0-foot intervals (0.3 to 9 meters in 0.3-meter intervals).

Note
• Speakers that you selected “No” or “None” for in the Speaker Size menu will not appear.

MENU STRUCTURE of Speaker Distance setup

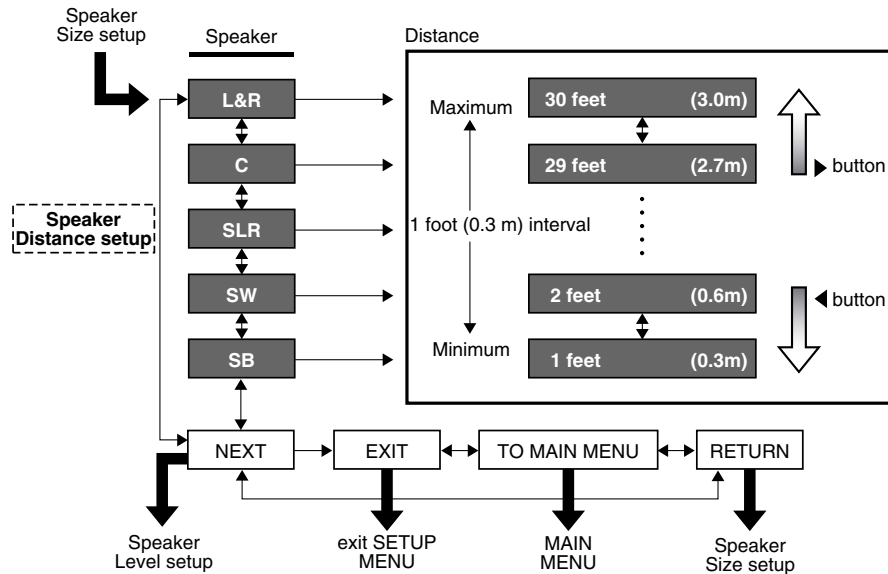

SPEAKERS LEVEL

Here you will set the volume for each speaker so that they are all heard by the listener at the same level.

Note:
• The speaker level settings is not available in 6.1 channel input mode and S-Direct mode.
TEST MODE : Selects “MANU (manual)” or “AUTO” for generating mode of test tone ◀ or ▶ cursor button.

If you select “AUTO” by pressing the ▼ button, the test tone will be cycled through in a circular pattern which is L (Left) → C (Center) → R (Right) → SR (Surround Right) → SB (Surround Back) → SL (Surround Left) → SW (Subwoofer) → L →... increments of 2 seconds for each channel.

Using the ◀ and ▶ cursor buttons, adjust the volume level of the noise from the speaker so that it is the same level for all speaker.

When you select “TO MAIN MENU” by pressing the OK button, you can return the SETUP MAIN MENU by pressing the OK button. Or press the ▲ or ▼ cursor button to select “EXIT” then press the OK button to exit the SETUP MENU.

Or press the ◀ or ▶ cursor button to select “RETURN” then press the OK button to return the previous “SPEAKER DISTANCE” setup.

If you select “MANU”, adjust the output level of each speaker as follow.

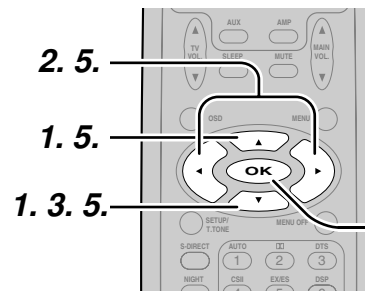

1. When you select “MANUAL” in T.MODE menu by pressing the ▲ or ▼ button, this unit will emit a pink noise from the front left speaker. At this time, adjust the desired level of the master volume. Remember the level of this noise and then press the ▼ button. This unit will emit the pink noise from the center speaker.

2. Using the ◀ and ▶ cursor buttons, adjust the volume level of the noise from the center speaker so that it is the same level as the front left speaker (Note that this can be adjusted to any level between -10 and +10 dB in 1dB intervals).

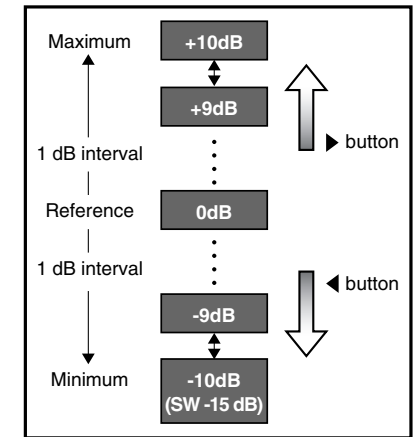

3. Press the ▼ cursor button again. This unit will now emit the pink noise from the front right speaker.

4. Repeat steps 2 and 3 above for the front right and other speakers until all speakers are adjusted to the same volume level.

5. When you select “TO MAIN MENU” by pressing the OK button, you can return the SETUP MAIN MENU by pressing the OK button. Or press the ▲ or ▼ cursor button to select “EXIT” then press the OK button to exit the SETUP MENU.

Or press the ◀ or ▶ button to select “RETURN” then press the OK button to return the previous “SPEAKER DISTANCE” setup.

Notes:

- Speakers that you selected “None” for in the Speaker Size Setup menu will not appear.
- The setup level for each channel is memorized for reproduction in all surround mode.
- To adjust the speaker levels for 6.1-channel input sources, you will need to use the 6.1CH Level Input setup menu.

MENU STRUCTURE of Speaker Level setup

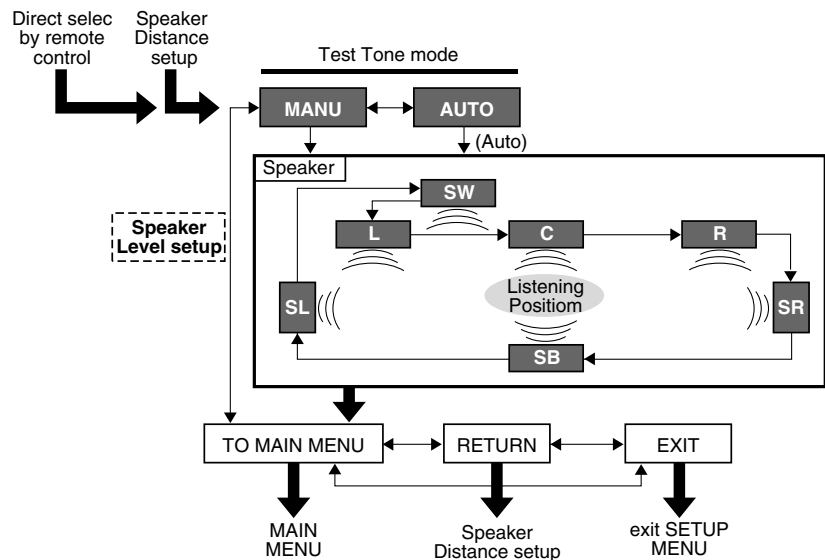

3. PREFERENCE

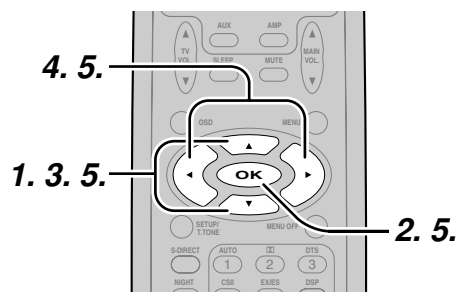

1. Select “3. PREFERENCE” in SETUP MAIN MENU with ▲ or ▼ cursor button.
2. Press the OK button.
3. Press ▲ or ▼ cursor button to select a desired item.

4. Press ◀ or ▶ cursor button to adjust.
5. When you select “TO MAIN MENU” by pressing the ▲ or ▼ button, you can return the SETUP MAIN MENU by pressing the OK button .
Or press the ◀ or ▶ cursor button to select “EXIT” then press the OK button to exit the SETUP MENU.

BASS MIX

- The bass mix setting is only valid when “LARGE” is set for the front speakers and “YES” is set for the subwoofer at stereo playback .
- When the “BOTH” is selected, the low frequency signal range of “LARGE” are produced simultaneously from those channels and the subwoofer channel.

When actual low frequency sound volume is weak depending on room size, use this function to fill low frequency sound equally in the room.

- When “Mix” is selected, subwoofer output is determined depending on the speaker sizes for each channels. If the front speaker size is set to “Large”, subwoofer output is only the LFE signal contained in Dolby Digital or DTS processed signals.

Note:

- When Front speaker is set ”SMALL”, then BASS MIX is set “MIX”. (The display appears “BASS MIX = ***”.)

LFE

- Select the output level of the LFE signal included in the Dolby Digital signal or the DTS signal. Select 0dB, -10 dB or OFF with Left or Right cursor button.
- This setting is available during a digital signal is playback.

MENU STRUCTURE of PREFERENCE setup

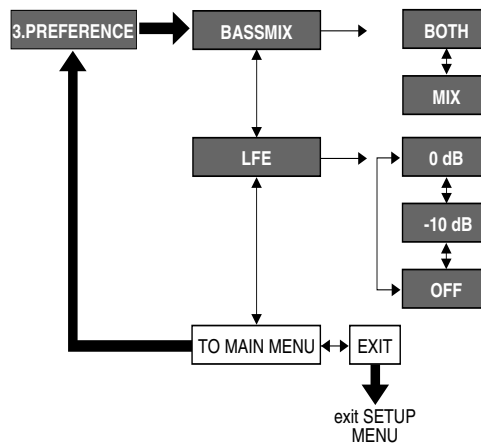

4. PL II (DOLBY PRO LOGIC II)

In this mode, the SR4400 includes three controls to fine-tune the sound-field as follow.

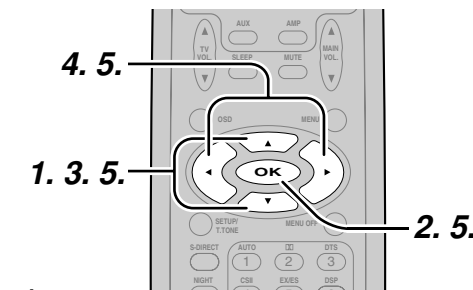

1. Select “4.PRO LOGIC II” in SETUP MAIN MENU with ▲ or ▼ cursor button.
2. Press the OK button to enter the menu.
3. Press ▲ or ▼ cursor button to select a desired item.
4. Press ◀ or ▶ cursor button to select the mode or set the level.
5. When you select “TO MAIN MENU” by pressing the ▲ or ▼ button, you can return the SETUP MAIN MENU by pressing the OK button .
Or press the ◀ or ▶ cursor button to select “EXIT” then press the OK button to exit the SETUP MENU.

PANORAMA:

Select the Panorama mode On or Off with ◀ or ▶ cursor button. Panorama wraps the sound of the front left and right speakers around you for an exciting perspective.

DIMENSION:

Set the Dimension level between 0 and 6 level in 1 level interval with ◀ or ▶ cursor button. Adjust the soundfield either towards the front or towards the rear. This can be useful to help achieve a more suitable balance from all the speakers with certain recordings.

C WIDTH:

Set the Center width level between 0 and 7 level in 1 level interval with ◀ or ▶ cursor button. Center Width allows you to gradually spread the center channel sound into the front left and right speakers. At its widest setting, all the sound from the center is mixed into the left and right. This control may help achieve a more spacious sound or a better blend of the front image. If “NONE” was selected for the Center speaker setting in the Speaker size, then this setting will not appear.

Note:

- When Center speaker is set "None", then C.WIDTH is set "7". (The display appears "C.WIDTH = ***".)

MENU STRUCTURE of PRO LOGIC II setup

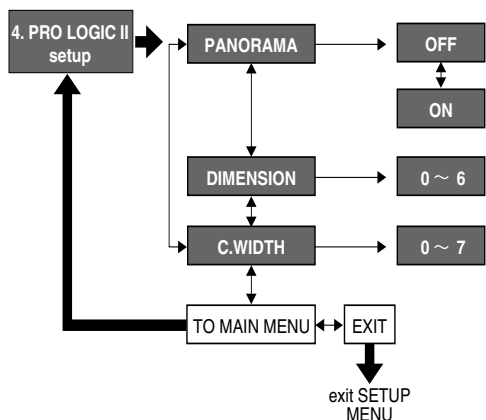

5. CS II (CIRCLE SURROUND II)

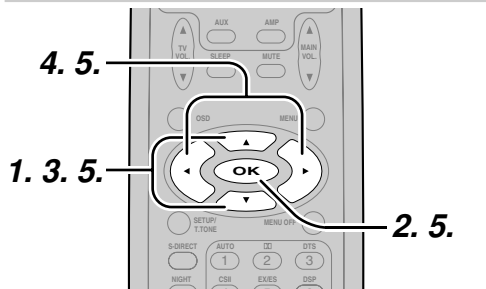

- Select "5. CS II" in SETUP MAIN MENU with ▲ or ▼ cursor button.
- Press the OK button to enter this menu.
- Press ▲ or ▼ cursor button to select desired item.
- Press ◀ or ▶ cursor button to set the level.
- When you select "TO MAIN MENU" by pressing the ▲ or ▼ button, you can return the SETUP MAIN MENU by pressing the OK button . Or press the ◀ or ▶ cursor button to select "EXIT" then press the OK button to exit the SETUP MENU.

TRUBASS:

Set the TRUBASS level between 0 and 6 level in 1 level interval with ◀ or ▶ cursor button. TRUBASS produced by the speakers to be an octave below the actual physical capabilities of the speakers adding exciting, deeper bass effects.

SRS DIALOG:

Set the SRS DIALOG level between 0 and 6 level in 1 level interval with ◀ or ▶ cursor button. This can be popped out of the surround audio effects allowing the listener to easily discern what the actors say. If "NONE" was selected for the Center speaker setting in the Speaker size, then this setting will not appear.

MENU STRUCTURE of CS II setup

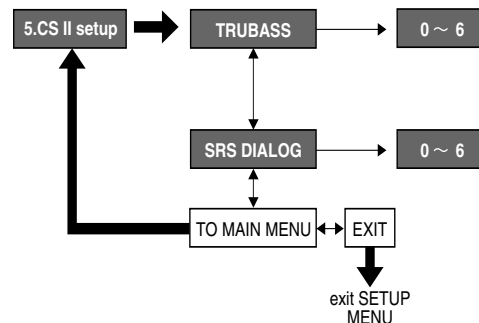

6. 6.1 CH INPUT LEVEL

This sub-menu is to adjust the speaker levels for 6.1-channel input sources. Here you will adjust the volume for each channel so that they are all heard by the listener at the same level.

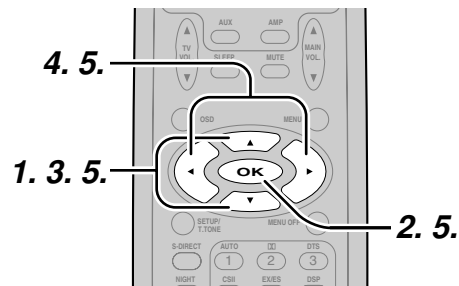

- Select "6. 6.1 CH IN" in SETUP MAIN MENU with ▲ or ▼ cursor button.
- Press the OK button to enter this menu.
- Press ▲ or ▼ cursor button to select desired channel.
- Using the ◀ or ▶ cursor button, adjust the volume level of each channel.

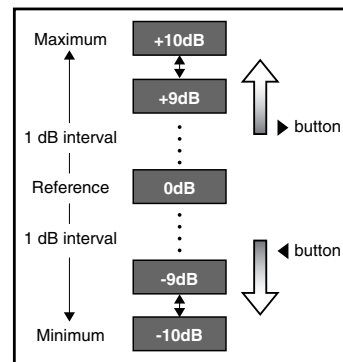

- When you select "TO MAIN MENU" by pressing the ▲ or ▼ button, you can return the SETUP MAIN MENU by pressing the OK button . Or press the ◀ or ▶ cursor button to select "EXIT" then press the OK button to exit the SETUP MENU.

Note:

- The condition of these setup will be memorized to 6.1CH INPUT source.

MENU STRUCTURE of 6.1CH IN setup

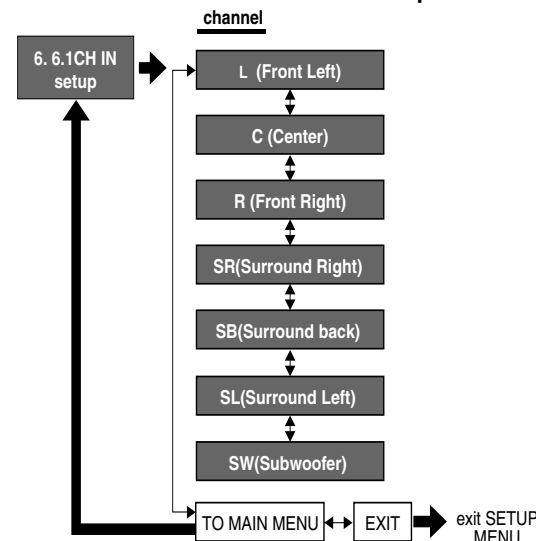

7. SURROUND

This sub menu is to adjust channel levels for each surround setting groups. There are three surround setting groups shown below. Therefore if settings for a surround mode are changed, settings for all other surround modes in the same group are also changed.

Surround setting group

- AUTO, DOLBY, DTS, EX/ES, VIRTUAL, STEREO
- Multi-ch stereo
- CS II

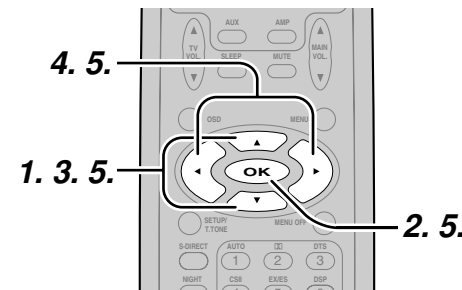

- Select "7. SURROUND" in SETUP MAIN MENU with ▲ or ▼ cursor button.
- Press the OK button.
- To select a desired item, press ▲ or ▼ cursor button.
- Using the ◀ or ▶ cursor button to select the mode or adjust the volume level of each speaker.
- When you select "TO MAIN MENU" by pressing the ▲ or ▼ button, you can return the SETUP MAIN MENU by pressing the OK button . Or press the ◀ or ▶ cursor button to select "EXIT" then press the OK button to exit the SETUP MENU.

SURR-MODE :

Select the desired surround mode with ◀ or ▶ cursor button.

- If one of the following modes is selected, all other modes are also set to the same. AUTO, DOLBY, DTS, EX/ES, VIRTUAL, STEREO.

SURR. L/R :

Adjust the volume level of the surround left/right speaker between -10 dB and +10 dB in 1 level interval with ◀ or ▶ cursor button.

- If "None" was selected for the Surround L/R speaker setting in the Speaker size, then this setting will not appear.

SURR. BACK :

Adjust the volume level of the surround back speaker between -10 dB and +10 dB in 1 level interval with ◀ or ▶ cursor button.

- If “None” was selected for the Surround back speakers setting in the Speaker size, then this setting will not appear.

CENTER :

Adjust the volume level of the center speaker between -10 dB and +10 dB in 1 level interval with ◀ or ▶ cursor button.

- If “None” was selected for the Center speaker setting in the Speaker size, then this setting will not appear.

SUB W :

Adjust the volume level of the subwoofer speaker between -15 dB and +10 dB in 1 level interval with ◀ or ▶ cursor button.

- If “None” was selected for the Subwoofer speaker setting in the Speaker size, then this setting will not appear.

When you select “TO MAIN MENU” by pressing the ▲ or ▼ button, you can return the SETUP MAIN MENU by pressing the OK button.

Note:

- SURR.L/R, SURR. BACK, CENTER and SUB W volume level are synchronized with SETUP MAIN MENU Speaker Level. (Page 18)

MENU STRUCTURE of SURROUND setup

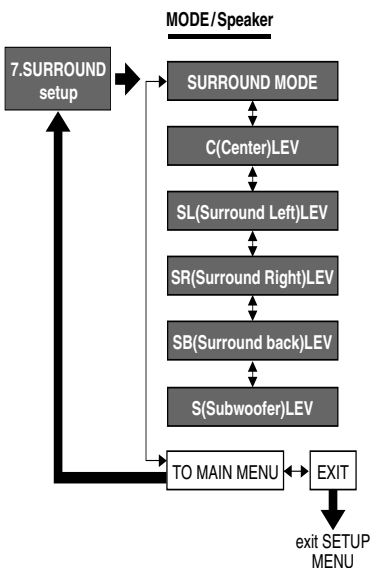

BASIC OPERATION (PLAY BACK)

SELECTING AN INPUT SOURCE.

Before you can listen to any input media, you must first select the input source at the SR4400.

E.G. : DVD

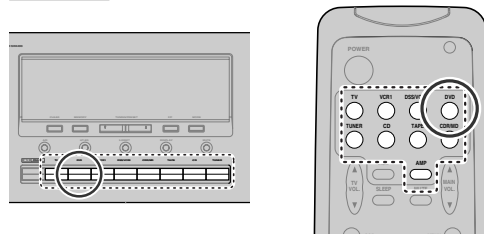

To select DVD, simply press the **DVD** button on the front panel or press **DVD** button on the remote. After you have selected DVD, simply turn on the DVD player and play the DVD.

- The input name will appear in the display on the front-panel.
- As the input is changed, the SR4400 will automatically switch to the digital input, surround mode, attenuation, and night mode status that were entered during the configuration process for that source.
- When an audio source is selected, the last video input used remains routed to the **VCR1 & DSS/ VCR2** Outputs and **Monitor** Outputs. This permits simultaneous viewing and listening to different sources.
- When a Video source is selected, the video signal for that input will be routed to the **Monitor Outputs** jack and will be viewable on a TV monitor connected to the SR4400.

SELECTING THE SURROUND MODE

E.G. : AUTO SURROUND

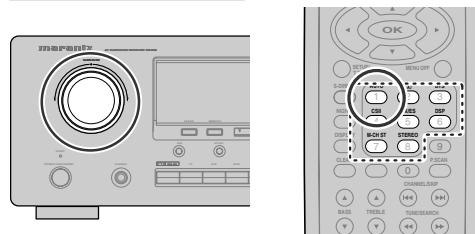

To select the surround mode during playback, turn the **SURROUND** knob on the front panel or press the surround mode button on the remote .

ADJUSTING THE MAIN VOLUME

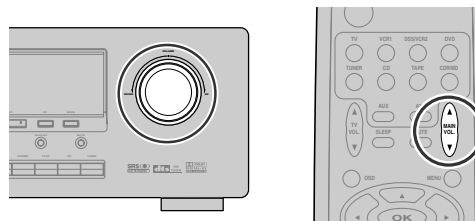

Adjust the volume to a comfortable level using the **VOLUME** control knob on the front panel or **MAIN VOL. ▲ / ▼** buttons on the remote.

To increase the volume, turn the **VOLUME** knob to clockwise or press **MAIN VOL. ▲** button on the remote, to decrease the volume, turn it to counterclockwise or press **MAIN VOL. ▼** button on the remote.

Notes:

- The volume can be adjusted within the range of -∞ to +18 dB, in steps of 1 dB.
- However, when the channel level is set as described on page 18, if the volume for any channel is set at +1 dB or greater, the volume cannot be adjusted up to +18 dB.

(In this case the maximum volume adjustment range is “+18 dB - Maximum value of channel level)

ADJUSTING THE TONE(BASS & TREBLE) CONTROL.

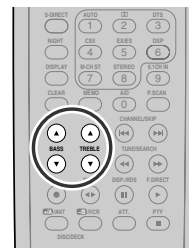

During a listening session you may wish to adjust the Bass and Treble Control to suit your listening tastes or room acoustics.

To adjust the bass effect , press **BASS▲** or **BASS▼** on the remote.

To adjust the treble effect , press **TREBLE▲** or **TREBLE▼** on the remote.

Notes :

- The tone control function can work for the front left and front right speakers.
- When Source Direct mode is set, tone control is disable.

TEMPORARILY TURNING OFF THE SOUND

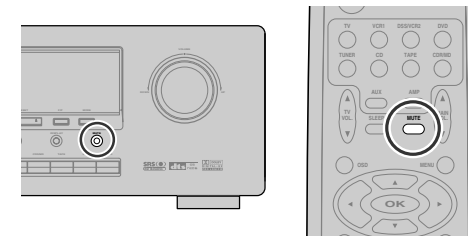

To temporarily silence all speaker outputs such as when interrupted by a phone call, press the **MUTE** button on the front panel or remote.

This will interrupt the output to all speakers and the head-phone jack, but it will not affect any recording or dubbing that may be in progress.

When the system is muted, the display will show “MUTE” .

Press the **MUTE** button again to return to normal operation.

USING THE SLEEP TIMER

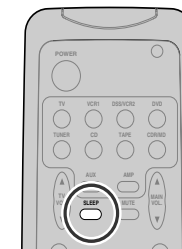

To program the SR4400 for automatic standby, press **SLEEP** button on the remote.

Each press of the button will increase the time before shut down in the following sequence.

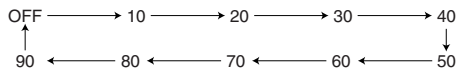

The sleep time will be shown for a few seconds in the display on the front panel, and it will count down until the time has elapsed.

When the programmed sleep time has elapsed, the unit will automatically turn off.

Note that the **SLEEP** indicator on the display will light up when the Sleep function is programmed.

To cancel the Sleep function, press the **SLEEP** button until the display shows to “**SLEEP OFF**” and the SLEEP indicator disappear.

NIGHT MODE



Press the **NIGHT** button on the remote to turn on the NIGHT mode.

Selecting the Night Mode ON is effective in Dolby Digital only, and it compresses the dynamic range. This softens loud passages such as sudden explosions, to help prevent disturbing others late at night.

To turn off the Night mode, press the **NIGHT** button again.

SURROUND MODE

The SR4400 is equipped with many surround modes. These are provided to reproduce a variety of surround sound effects, according to the content of the source to be played.

The available surround modes may be restricted depending on the input signal and speaker setup. When using the remote control, press **AMP** button and press the desired surround mode button.

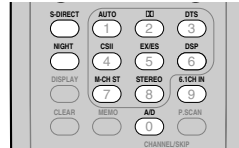

AUTO

When this mode is selected, the receiver determines whether the digital input signal is Dolby Digital, Dolby Digital Surround EX, DTS, DTS-ES or PCM-audio.

Surround EX & DTS-ES will operate for multi channel source that has a Dolby Digital Surround EX or DTS-ES auto trigger flag in the digital signal. When a Dolby Digital or DTS signal is input, the number of channels for which the corresponding signal is encoded will be played.

Inputting a Dolby Digital two channel signal with Dolby surround status automatically subjects that signal to Pro Logic II movie processing before play.

PCM 96 kHz source material can be played in this mode.

Notes:

- When you use this mode with certain DVD and CD players, performing operations such as “Skip” or “Stop” may momentarily interrupt the output.
- When the signal is not decoded is input for using mode, the mode is changed to AUTO mode automatically. Refer to page 24 to confirm the available decoding mode.

DD MODE

(Dolby Digital, Pro Logic II MOVIE, Pro Logic II MUSIC, Pro Logic)

This mode is used with source materials encoded in Dolby Digital and Dolby Surround.

DOLBY DIGITAL

This mode is enabled when playing source materials encoded in Dolby Digital.

Playing multi-channel encoded 5.1-channel Dolby Digital sources provides five main audio channels (left, center, right, surround left and surround right)

and Low Frequency Effect channel.

Dolby Digital EX decoding is not available in this mode.

Dolby Pro Logic II brings the excitement of surround sound to any stereo mix, while making existing Dolby Surround mixes sound more like discrete 5.1 channels Surround sound.

Dolby Pro Logic II has below 3 modes.

Pro Logic II MOVIE

This mode provides 5.1 channel surround sound from Dolby Surround encoded stereo movie sound tracks.

Pro Logic II MUSIC

This mode provides 5.1 channel surround sound from conventional stereo sources, analog or digital, such as CD, tape, FM, TV, stereo VCR, etc.

Pro Logic

This mode emulated original Dolby Pro Logic decoding (3/1 surround) suit for Dolby Surround encoded stereo movie soundtracks.

Notes:

- Pro Logic II mode is available to 2ch input signal which is encoded Dolby Digital or PCM format.
- PCM-audio signals can be subjected to Pro Logic processing when the sampling frequency is 32 kHz, 44.1 kHz or 48 kHz.

EX/ES

This mode provides 6.1 channel surround for DOLBY DIGITAL EX, DTS-ES encoded source material such as DVD.

This mode cannot be used when an analog input has been selected.

Dolby Digital EX

In a movie theater, film soundtracks that have been encoded with Dolby Digital surround EX technology are able to reproduce an extra channel which has been added during the mixing of the program.

This channel, called Surround Back, places sounds behind the listener in addition to the currently available front left, front center, front right, surround right, surround left and subwoofer channels.

This additional channel provides the opportunity for more detailed imaging behind the listener and brings more depth, spacious ambience and sound localization than ever before.

Dolby Digital EX is not available in the system without surround back speaker.

DTS-ES (Discrete 6.1, Matrix 6.1)

DTS-ES adds the surround back channel audio to the DTS 5.1-channel format to improve the acoustic positioning and makes acoustic image movement more natural with the 6.1-channel reproduction.

This receiver incorporates a DTS-ES decoder, which can handle DTS-ES Discrete-encoded and DTS-ES Matrix-encoded program sources from DVD, etc..

DTS-ES Discrete 6.1 features digital discrete recording of all channels including the surround back channels and higher quality of audio reproduction.

DTS-ES is not available in the system without surround back speaker.

dts MODE

(dts, Neo:6 Cinema, Neo:6 Music)

This mode is for DTS encoded source materials such as LASER

DISC, CD, and DVD and some 2channel signal source.

dts : This mode is enabled when playing source materials encoded in dts multi channel.

Playing multi-channel encoded 5.1-channel dts sources provides five main audio channels (left, center, right, surround left and surround right) and Low Frequency Effect channel.

dts-ES decoding is not available in this mode.

The DTS mode cannot use when an analog input has been selected.

Neo:6 Cinema, Neo:6 Music

This mode decodes 2-channel signals into 6-channel signals using high-accuracy digital matrix technology.

The DTS NEO:6 decoder has near-discrete properties in the frequency characteristics of the channels as well as in channel separation.

According to the signals to be played back, DTS NEO:6 uses either the NEO:6 CINEMA mode optimized for movie playback or the NEO:6 MUSIC mode optimized for music playback.

Note:

- PCM-audio (32 kHz, 44.1 kHz or 48 kHz) and analog source material can playback in this mode.

MULTI CH. ST

This mode is used to create a wider, deeper and more natural soundstage from two channel source material.

This is done by feeding the left channel signal to both left front and left surround speaker and the right channel signal to both right front and right surround speaker. Additionally, the center channel reproduces a mix of the right and left channel.

CIRCLE SURROUND II (CSII-CINEMA, CSII-MUSIC, CSII-MONO)

Circle Surround is designed to enable multi-channel surround sound playback of non-encoded and multi-channel encoded material.

Backward compatibility provides listeners with up to 6.1 channels of surround performance from entire collection of music and film, including broadcast, videotape and stereo recorded music. Regarding to source material, you can select **CSII-Cinema** mode, **CSII-Music** mode or **CSII-Mono** mode.

Note:

- PCM-audio (32 kHz, 44.1 kHz or 48 kHz) and analog source material can playback in this mode.

VIRTUAL

This mode creates a virtualized surround sound experience from a two-speaker (front L and R) playback system playing any multi-channel audio source (such as found on DVDs and digital broadcasts), including Dolby Digital, Dolby Pro Logic or DTS.

DSP SURROUND (MOVIE, HALL, STADIUM, MATRIX)

These modes provide surround effect processing from each input source material.

They will produce theater, concert hall and stadium like atmospheres. Select as your taste desires.

Note:

- When using the remote control, press the numeric button **6 (DSP)** to change the surround effect.
- PCM-audio (32 kHz, 44.1 kHz or 48 kHz) and analog source material can playback in this mode.

STEREO

This mode bypasses all surround processing.

Stereo program sources the left and right channels play normally when PCM-audio or analog stereo is input.

With Dolby Digital and DTS sources, the 5.1 multi-channels are converted to two channel stereo. 96 kHz PCM source material can be playback in stereo mode.

S (SOURCE) - DIRECT

In the source direct mode, the tone control circuit and bass management configuration are bypassed for full range frequency response and the purist audio reproduction.

96 kHz PCM source material can be play back in this mode.

Notes:

- Internal speaker size is setup to front L/R = Large, Center = Large, Surround L/R = Large and Subwoofer = yes automatically. Tone controls and additional processing are also defeated.
- When you use this mode with certain DVD and CD players, performing operations such as "Skip" or "Stop" may momentarily interrupt the output.

CAUTION***NOTE for DTS signal***

- * Connected DVD-player, laser-disc player or CD-player needs to support DTS-digital output. You may not be able to play some DTS source signals from certain CD players and LD players even if you connect the player to the SR4400 digitally. This is because the digital signal has been processed (such as the output level, sampling frequency, or frequency response) and the SR4400 cannot recognize the signal as DTS data.
- * Depending on the player used, DTS play may produce short noise. This is not a malfunction. In such cases, select the surround mode the "DTS" or "DTS-ES".
- * While signals from DTS-laser disc or CD are playing in another Surround mode, you cannot switch to digital input or from digital input to analog input by INPUT SETUP in SETUP MAIN MENU or A/D button.
- * The outputs for the VCR 1 OUT, DSS/VCR 2 OUT, TAPE OUT, and CD-R OUT output analog audio signals. Do not record from CDs or LDs that support DTS using these outputs. If you do, the DTS-encoded signal will be recorded as noise.

NOTE for Dolby Digital Surround EX signal

- * When playing Dolby Digital Surround EX-encoded software in 6.1 channels, it is required to set the EX/ES mode.
- * Note that some of Dolby Digital Surround EX-encoded software does not contain the identification signal. In this case, set the EX/ES mode manually.

NOTE for 96kHz PCM audio

- * AUTO, Source- DIRECT, and STEREO modes can be used when playing PCM signals with a sampling frequency of 96 kHz (such as from DVD-Video discs that contain 24 bit, 96 kHz audio). If such signals are input during playback in one of the other surround modes, output from SR4400 will be muted.
- * Certain DVD player models inhibit digital output. For details, refer to the player's operation manual.
- * Some DVD formatted discs featured copy protection. When using such disc, 96 kHz PCM signal is not output from the DVD player. For details, refer to the player's operation manual.

The relation between the selected surround mode and the input signal

The surround mode is selected with the surround mode knob on SR4400 or the remote control unit. However, the sound you hear is subject to the relationship between the selected surround mode and input signal. That relationship is as next page;

Surround Mode	Input Signal	Decoding	Output Channel					Front information display		
			L/R	C	SL SR	SB	SW	Dot matrix display	Signal format indicators	Channel status
AUTO	Dolby Surr. EX	Dolby Digital EX	○	○	○	○	○	DOLBY D EX	□□ DIGITAL, EX	L, C, R, SL, SR, S, LFE
	Dolby D (5.1ch)	Dolby Digital 5.1	○	○	○	-	○	DOLBY D	□□ DIGITAL	L, C, R, SL, SR, LFE
	Dolby D (2ch)	Dolby Digital 2.0	○	-	-	-	○	DOLBY D	□□ DIGITAL	L, R
	Dolby D (2ch Surr)	Pro Logic II movie	○	○	○	-	○	DOLBY PL II MV	□□ DIGITAL, □□ SURROUND	L, R, S
	DTS-ES	DTS-ES	○	○	○	○	○	DTS-ES Disc or DTS-ES Mtrx	dts, ES	L, C, R, SL, SR, S, LFE
	DTS (5.1ch)	DTS 5.1	○	○	○	-	○	DTS	dts	L, C, R, SL, SR, LFE
	PCM (Audio)	PCM (Stereo)	○	-	-	-	○	STEREO	PCM	L, R
	PCM 96kHz	PCM (96kHz Stereo)	○	-	-	-	○	STEREO	PCM, 96kHz	L, R
Analog	Stereo	○	-	-	-	○	STEREO	ANALOG	-	
S-DIRECT	Dolby D Surr. EX	Dolby Digital EX	○	○	○	○	○	DOLBY D EX	□□ DIGITAL, EX	L, C, R, SL, SR, S, LFE
	Dolby D (5.1ch)	Dolby Digital 5.1	○	○	○	-	○	DOLBY D	□□ DIGITAL	L, C, R, SL, SR, LFE
	Dolby D (2ch)	Dolby Digital 2.0	○	-	-	-	○	DOLBY D	□□ DIGITAL	L, R
	Dolby D (2ch Surr)	Pro Logic II movie	○	○	○	-	○	DOLBY PL II MV	□□ DIGITAL, □□ SURROUND	L, R, S
	DTS-ES	DTS-ES	○	○	○	○	○	DTS-ES Disc or DTS-ES Mtrx	dts, ES	L, C, R, SL, SR, S, LFE
	DTS (5.1ch)	DTS 5.1	○	○	○	-	○	DTS	dts	L, C, R, SL, SR, LFE
	PCM (Audio)	PCM (Stereo)	○	-	-	-	○	STEREO	PCM	L, R
	PCM 96kHz	PCM (96kHz Stereo)	○	-	-	-	○	STEREO	PCM, 96kHz	L, R
Analog	Stereo	○	-	-	-	○	STEREO	ANALOG	-	
EX/ES	Dolby D Surr. EX	Dolby Digital EX	○	○	○	○	○	DOLBY D EX	□□ DIGITAL, EX	L, C, R, SL, SR, S, LFE
	Dolby D (5.1ch)	Dolby Digital EX	○	○	○	○	○	DOLBY D EX	□□ DIGITAL	L, C, R, SL, SR, LFE
	DTS-ES	DTS-ES	○	○	○	○	○	DTS-ES Disc or DTS-ES Mtrx	dts, ES	L, C, R, SL, SR, S, LFE
	DTS (5.1ch)	DTS-ES	○	○	○	○	○	DTS-ES Mtrx	dts	L, C, R, SL, SR, LFE
DOLBY (PLII MOVIE) (PLII MUSIC) (PRO LOGIC)	Dolby D Surr. EX	Dolby Digital 5.1	○	○	○	-	○	DOLBY D	□□ DIGITAL, EX	L, C, R, SL, SR, S, LFE
	Dolby D (5.1ch)	Dolby Digital 5.1	○	○	○	-	○	DOLBY D	□□ DIGITAL	L, C, R, SL, SR, LFE
	Dolby D (2ch)	Pro Logic II	○	○	○	-	○	DOLBY PL	□□ DIGITAL	L, R
	Dolby D (2ch Surr)	Pro Logic II	○	○	○	-	○	or DOLBY PLII MV	□□ DIGITAL, □□ SURROUND	L, R, S
	PCM (Audio)	Pro Logic II	○	○	○	-	○	or DOLBY PLII MS	PCM	L, R
	Analog	Pro Logic II	○	○	○	-	○		ANALOG	-
DTS (Neo:6 Cinema) (Neo:6 Music)	DTS-ES	DTS 5.1	○	○	○	-	○	DTS	dts, ES	L, C, R, SL, SR, S, LFE
	DTS (5.1ch)	DTS 5.1	○	○	○	-	○	DTS	dts	L, C, R, SL, SR, LFE
	PCM (Audio)	Neo:6	○	○	○	○	○	NEO:6 CINEMA	PCM	L, R
	Analog	Neo:6	○	○	○	○	○	or NEO:6 MUSIC	ANALOG	L, R
CSII CINEMA CSII MUSIC CSII MONO	PCM (Audio)	CSII	○	○	○	○	○	CSII CINEMA	PCM	L, R
	Analog	CSII	○	○	○	○	○	or CSII MUSIC or CSII MONO	ANALOG	-
STEREO	Dolby Surr. EX	Stereo	○	-	-	-	○	STEREO	□□ DIGITAL, EX	L, C, R, SL, SR, S, LFE
	Dolby D (5.1ch)	Stereo	○	-	-	-	○	STEREO	□□ DIGITAL	L, C, R, SL, SR, LFE
	Dolby D (2ch)	Stereo	○	-	-	-	○	STEREO	□□ DIGITAL	L, R
	Dolby D (2ch Surr)	Stereo	○	-	-	-	○	STEREO	□□ DIGITAL, □□ SURROUND	L, R, S
	DTS-ES	Stereo	○	-	-	-	○	STEREO	dts, ES	L, C, R, SL, SR, S, LFE
	DTS (5.1ch)	Stereo	○	-	-	-	○	STEREO	dts	L, C, R, SL, SR, LFE
	PCM (Audio)	Stereo	○	-	-	-	○	STEREO	PCM	L, R
	PCM 96kHz	Stereo	○	-	-	-	○	STEREO	PCM, 96kHz	L, R
Analog	Stereo	○	-	-	-	○	STEREO	ANALOG	-	
VIRTUAL	Dolby Surr. EX	Virtual	○	-	-	-	○	VIRTUAL	□□ DIGITAL, EX	L, C, R, SL, SR, S, LFE
	Dolby D (5.1ch)	Virtual	○	-	-	-	○	VIRTUAL	□□ DIGITAL	L, C, R, SL, SR, LFE
	Dolby D (2ch)	Virtual	○	-	-	-	○	VIRTUAL	□□ DIGITAL	L, R
	Dolby D (2ch Surr)	Virtual	○	-	-	-	○	VIRTUAL	□□ DIGITAL, □□ SURROUND	L, R, S
	DTS-ES	Virtual	○	-	-	-	○	VIRTUAL	dts, ES	L, C, R, SL, SR, S, LFE
	DTS (5.1ch)	Virtual	○	-	-	-	○	VIRTUAL	dts	L, C, R, SL, SR, LFE
	PCM (Audio)	Virtual	○	-	-	-	○	VIRTUAL	PCM	L, R
Analog	Virtual	○	-	-	-	○	VIRTUAL	ANALOG	-	
MULTI CH ST	Dolby Surr. EX	Dolby Digital EX	○	○	○	○	○	M-CH STEREO	□□ DIGITAL, EX	L, C, R, SL, SR, S, LFE
	Dolby D (5.1ch)	Dolby Digital EX	○	○	○	○	○	M-CH STEREO	□□ DIGITAL	L, C, R, SL, SR, LFE
	Dolby D (2ch)	Multi Channel Stereo	○	○	○	-	○	M-CH STEREO	□□ DIGITAL	L, R
	Dolby D (2ch Surr)	Multi Channel Stereo	○	○	○	-	○	M-CH STEREO	□□ DIGITAL, □□ SURROUND	L, R, S
	DTS-ES	DTS-ES	○	○	○	○	○	M-CH STEREO	dts, ES	L, C, R, SL, SR, S, LFE
	DTS (5.1ch)	DTS-ES	○	○	○	○	○	M-CH STEREO	dts	L, C, R, SL, SR, LFE
	PCM (Audio)	Multi Channel Stereo	○	○	○	-	○	M-CH STEREO	PCM	L, R
Analog	Multi Channel Stereo	○	○	○	-	○	M-CH STEREO	ANALOG	-	
DSP SURROUND (MOVIE) (HALL) (STADIUM) (MATRIX)	PCM (Audio)	DSP	○	○	○	-	○	MOVIE	PCM	L, R
	Analog	DSP	○	○	○	-	○	or HALL or STADIUM or MATRIX	ANALOG	-

Dolby Surr.EX:

Dolby Digital stream with Surround EX flag

DTS-ES:

DTS digital stream with ES flag.

Dolby D(2ch Surr) :

2channel Dolby Digital stream with Dolby Surround flag

L/R = Front Left and Right speakers

C = Center speaker

SL/SR = Surround Left and Right speakers

SB = Surround back speaker

SW = Sub woofer speaker

OTHER FUNCTION

ATTENUATION TO ANALOG INPUT SIGNAL



When the input signal is too high and the voice distorts even by throttling the SR4400 VOLUME control, turn on this function. "ATT" is indicated when this function is activated. "ATT" indicator will light up when this function is activated. The signal-input level is reduced by about the half. Attenuation will not work with the output signal of TAPE-OUT, CD-R/MD-OUT, VCR1-OUT and DSS/VCR2-OUT. This function is memorized for each individual input source.

LISTENING OVER HEADPHONES

This jack may be used to listen to the SR4400's output through a pair of headphones. Be certain that the headphones have a standard 1/4" stereo phone plug. (Note that the main room speakers will automatically be turned off when the headphone jack is in use.)

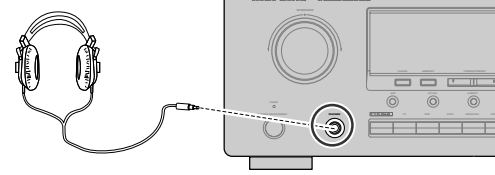

- Notes:**
- When using headphones, the surround mode will automatically change to STEREO.
 - The surround mode returns to the previous setting as soon as the plug is removed from the jack.

DIMMER (DISPLAY)

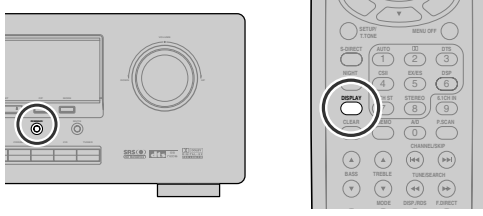

You can change the display brightness of the front display. Press the **DISPLAY** button to change the brightness. When this button is pressed, the brightness is changed in the following sequence. → dimmed → Display Off → normal → dimmed

- Note:**
- Only DISP indicator will light up on the front display in display off condition

SELECTING ANALOG AUDIO INPUT OR DIGITAL AUDIO INPUT

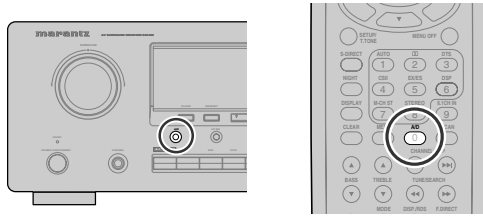

If you have already assign any digital input to input source. You can select temporarily the audio input mode for each input source with the **A/D** button on the remote controller or front panel. When this button is pressed, the input mode is switched in the following sequence. → Digital Auto → Digital → Analog → Digital Auto....

In Digital Auto mode, the types of signals being input to the digital and analog input jacks for the selected input source are detected automatically. If no digital signal is being input, the analog input jacks are selected automatically.

In Digital mode, input is fixed to an assigned digital input terminal. In analog mode, the analog input jacks are selected. This selecting is temporarily, so the result will not be stored in memory. If you need to change input mode completely, use **SYSTEM SETUP** in **SETUP** menu system. (see page 16)

RECORDING AN ANALOG SOURCE

In normal operation, the audio or video source selected for listening through the SR4400 is sent to the record outputs. This means that any program you are watching or listening to may be recorded simply by placing machines connected to the outputs for **TAPE OUT**, **CD-R/MD OUT**, **VCR1 OUT**, and **DSS/VCR2 OUT** in the record mode.

To record the input source signal you are currently watching or listening to

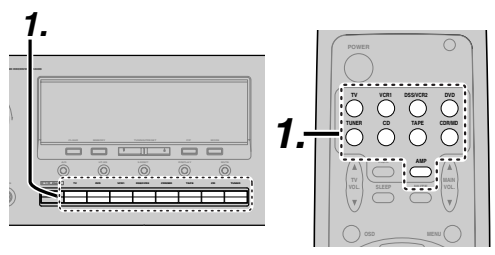

1. Select the input source to record by pressing the corresponding **input selector** button. The input source is now selected and you may watch or listen to it as desired.
2. Outputs the currently selected input source signal to the **TAPE OUT**, **CD-R/MD OUT**, **VCR1 OUT**, and **DSS/VCR2 OUT** outputs for recording.
3. Start recording at the recording component as desired.

- Notes:**
- If you change the input source during recording, you will record the signals from the newly selected input source.
 - You cannot record the surround effects.

- Digital input signals are only output to the digital outputs. There is no conversion from digital to analog .
- When connecting CD players and other digital components, do not connect only the digital terminals, but the analog ones as well.

HT-EQ

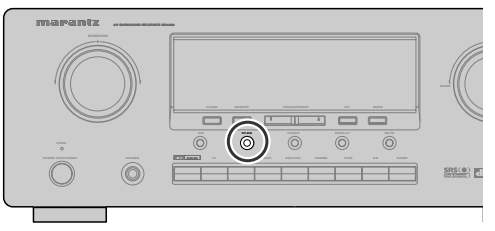

Press the **HT-EQ** button on the front panel to turn on the HT-EQ mode. The tonal balance of a film soundtrack will be excessively bright and harsh when played back over audio equipment in the home. This is because film soundtracks were designed to be played back in large movie theater environments. Activating the HT-EQ feature when watching a film made for movie theaters corrects this and restores the correct tonal balance. The HT-EQ feature can be activated only while in Dolby Pro Logic Mode, or while decoding Dolby Digital or DTS encoded material.

6.1 CH INPUT.

The SR4400 is equipped for future expansion through the use of Multi channel SACD multi channel player or DVD-Audio player. This is selected, the input signals connected to the Front left, Front right, Center, Surround left, Ssurround right and Surround back channels of the 6.1 CH. In jacks are output directly to the front (left and right), center, surround (left and right) and surround back speaker systems as well as the pre-out jacks without passing through the surround circuitry. In addition, the signal input to the SW (subwoofer) jack is output to the PRE OUT SW (subwoofer) jack. When 6.1 CH. INPUT is selected, the last video input used remains routed to the Monitor Outputs. This permits simultaneous viewing with video sources.

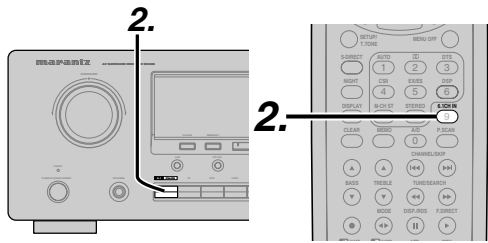

1. Select a desired Video source to decide the routed video signal to the Monitor Outputs .
2. Press the **6.1 CH-IN** button on the front panel or on the remote to switch the 6.1 channel input.

3. If necessary to adjust the output level of each channel, use "6.1 Ch. INPUT LEVEL" in SETUP menu system as desired.

Adjust the speaker output levels so that you can hear the same sound level from each speaker at the listening position. For the front left, front right, center, surround left, surround right and surround back speakers, the output levels can be adjusted between -10 to +10 dB.

The subwoofer can be adjusted between -15 and +10 dB.

These adjusting result will be stored to 6.1 Ch. INPUT condition. (see to page 20)

4. Adjust the main volume with the MAIN VOLUME knob or the VOL buttons on the remote.

To cancel the 6.1 Ch. INPUT setting, press the **6.1 CH-IN** button on the front panel or on the remote.

Notes:

- When the 6.1 Ch. Input is in use, you may not select a surround mode, as the external decoder determines processing.
- In addition, there is no signal at the record outputs when the 6.1 Ch. Input is in use.

BASIC OPERATION (TUNER)

LISTENING TO THE TUNER

AUTO TUNING

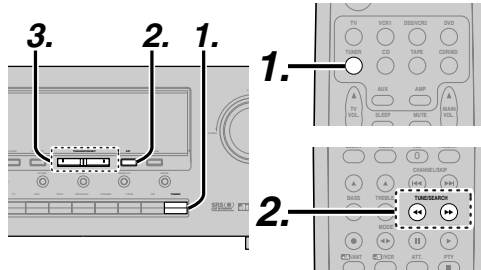

(Using the SR4400)

1. To select tuner and desired band (FM or AM), press the **TUNER** button on the front panel.
2. Press the **F/P**(Frequency/Preset) button on the front panel to appears frequency on the display.
3. Press the **TUNING ▲** or **▼** button on the front panel for more than 1 second to start the Auto tuning function.
4. Automatic searching begins then stops when a station is tuned in.

(Using the remote control unit)

1. To select tuner and desired band (FM or AM), press the **TUNER** button twice within in two seconds on the remote.
2. Press **◀** or **▶** more than 1 second on the remote.
3. Automatic searching begins then stops when a station is tuned in.

If tuning does not stop at the desired station, use to the "Manual tuning" operation.

MANUAL TUNING

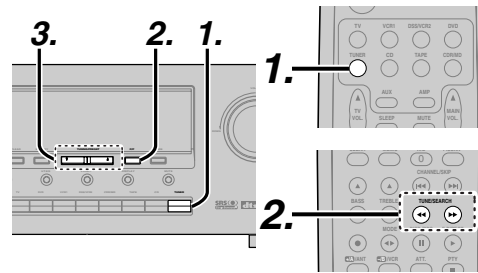

(Using the SR4400)

1. To select tuner and desired band (FM or AM), press the **TUNER** button on the front panel
2. Press the **F/P**(Frequency/Preset) button on front panel to appears frequency on the display.
3. Press the **TUNING ▲** or **▼** button.

(Using the remote control unit)

1. To select tuner and desired band (FM or AM), press **TUNER** button twice within in two seconds on the remote.
2. Press **◀** or **▶** on the remote to tune in the desired station.

DIRECT FREQUENCY CALL

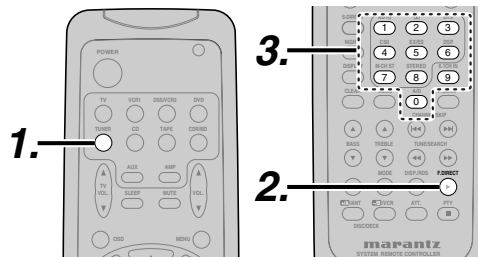

1. To select tuner and desired band (FM or AM), press the **TUNER** on the remote.
2. Press the **F.DIRECT** button on the remote, display will show "FREQ ---".
3. Input your desired station's frequency with **numeric buttons** on the remote.
4. The desired station will automatically be tuned.

(FM) TUNING MODE (AUTO STEREO OR MONO)

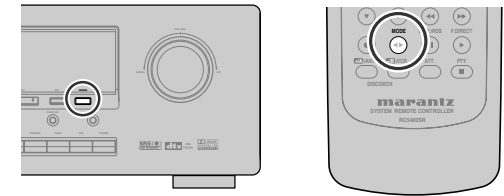

When in the auto stereo mode, **AUTO** indicator keeps to light on the display. The "**ST**" indicator lights on when a stereo broadcast is tuned in. At open frequencies, the noise is muted and the "**TUNED**" and "**ST**" indicators turn off.

If the signal is weak, it may be difficult to tune into the station in stereo. In such a case, press the **MODE** button on the front panel or on the remote. "**AUTO**" indicators turn off ,FM stereo broadcasts are received in monaural and the "**ST**" indicator turns off.

To return to auto stereo mode, press the **MODE** button on the front panel or on the remote again. **AUTO** indicator lights on the display.

PRESET MEMORY

With this unit you can preset up to 30 FM/AM stations in any order.

For each station, you can memorize the frequency and reception mode if desired.

AUTO PRESET MEMORY

This function automatically scans the FM and AM band and enters all stations with proper signal strength into the memory.

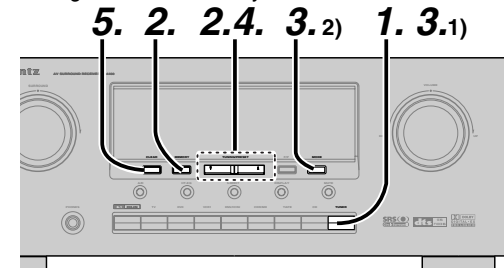

1. To select FM , press the **TUNER** button on the front panel.
2. While pressing the **MEMORY** button, press the **TUNING ▲** button to up.

- “**AUTO PRESET**” will appear on the display, and scanning starts from lowest frequency.
- Each time the tuner finds a station, scanning will pause and the station will be played for five seconds.
During this time, the following operations are possible.
 - The band can be changed by **TUNER** button .
 - If no button is pressed during this period, the current station is memorized in location Preset 02
 - If you wish to skip the current station, press the **TUNING ▲** button during this period, this station is skipped and auto presetting continues.
 - Operation stops automatically when all 30 preset memory positions are filled or when auto scanning attains the highest end of all bands. If you desire to stop the auto preset memory at anytime, press the **CLEAR** button.

MANUAL PRESET MEMORY

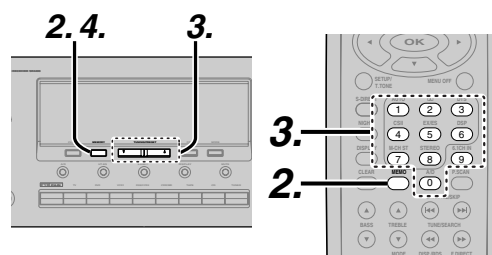

(Using the SR4400)

- Tune into the radio station you desire (Refer to the “**MANUAL TUNING**” or “**AUTO TUNING**” section).
- Press the **MEMORY** button on the front panel. “- -” (preset number) starts blinking on the display.
- Select the preset number by pressing the **TUNING ▲** or **▼** button, while this is still blinking (approx. 5 seconds)
- Press the **MEMORY** button again to enter. The display stops blinking. The station is now stored in the specified preset memory location.

(Using the remote control unit)

- Tune into the radio station you desire (Refer to the “**MANUAL TUNING**” or “**AUTO TUNING**” section).

- Press the **MEMO** button on the remote unite. “- -” (preset number) starts blinking on the display.
- Enter the desired preset number by pressing **numeric buttons**.

Note:

- When entering a single digit number (2 for example), either input “02” or just input “2” and wait for a few seconds.

RECALLING A PRESET STATION

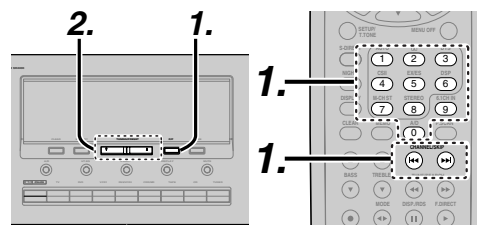

(Using the SR4400)

- Press the **F/P** button to show the preset station on the display.
- Select the desired preset station by pressing the **TUNING ▲** or **▼** button on the front panel

(Using the remote control unit)

- Press the **◀** or **▶** button to select the desired preset station, or input your desired preset channel with **numeric buttons** on the remote.

PRESET SCAN

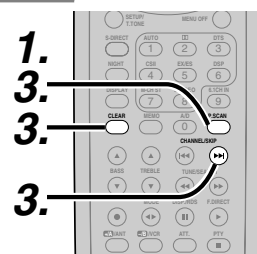

(Using the remote control unit)

- Press the **P.SCAN** on remote. “**PRESET SCAN**” appears on the display and then the preset station with the lowest preset number is recalled first.
- Preset stations are recalled in sequence (No. 1 → No.2 → etc.) for 5 seconds each. No stored preset number will be skipped.

- You can fast forward the preset stations by pressing the **▶▶** continuously. When the desired preset station is received, cancel the preset scan operation by pressing the **CLEAR** or **P.SCAN**.

CLEARING STORED PRESET STATIONS

You can remove preset stations from memory using the following procedure.

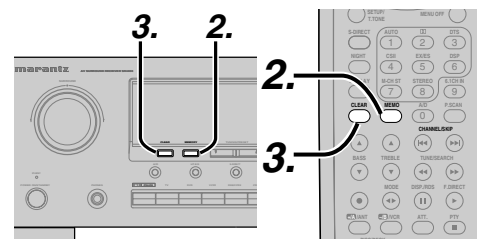

- Recall the preset number to be cleared with the method described in “**RECALLING**” a preset station.
- Press the **MEMORY** button on the front panel or press **MEMO** button on the remote.
- Stored preset number blinks in the display for 5 seconds. While blinking, press the **CLEAR** button on the front panel or press **CLEAR** on the remote unit.
- “**xx CLEAR**” appears on the display to indicate that the specified preset number has been cleared.

Notes:

- To clear stored all preset stations, press and hold the **CLEAR** and the **F/P** buttons for two seconds.

NAME INPUT OF THE PRESET STATION

This function allows the name of each preset channel to be entered using alphanumeric characters. Before name inputting, need to store preset stations with the preset memory operation.

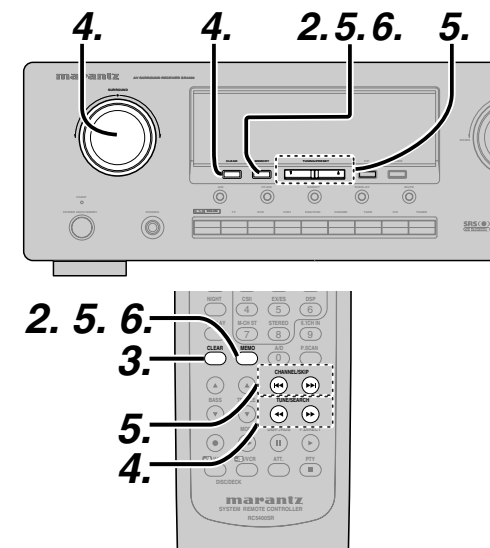

- Recall the preset number to be inputted name with the method described in “**RECALLING**” a preset station.
- Press the **MEMORY** button on the front panel or press **MEMO** on the remote for more than 3 seconds.
- The left most column of the station name indicator flashes, indicating the character entry ready status.
- When the **SELECT** knob is turned or press **◀** / **▶▶** button on the remote, alphabetic and numeric characters will be displayed in the following order:
A → B → C ... Z → 1 → 2 → 3 0 → - → + → / → (Blank) → A
UP →
← DOWN

To clear the input charcter, press the **CLEAR** button on the front panel or on the remote.

- After selecting the first character to be entered, press the **MEMORY** button on the front panel, or press **MEMO** button on the remote. The entry in this column is fixed and the next column starts to flash. Fill the next column same as.

To move back and forth between the characters, press the **TUNING ▲ / ▼** button or press **◀ / ▶** buttons on the remote.

Note:

- Unused columns should be filled by entering blanks.

6. To save name, press the **MEMORY** button, press **MEMO** button on the remote for more than 2 seconds.

- You can input the alphabetic and numeric characters with the ten keypad of the remote control in the previous step 4 and 5.

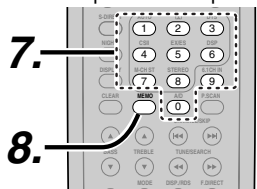

7. Enter the character using the ten keypad. For example, to enter "A":

1) Press the "1" button. "A" appears on the display column.

2) Every time the 1 button is pressed, the displayed character changes in the order: **A → B → C → 1 → A...**

Pressing buttons other than the "1" button cause different characters to be displayed in a similar way, so that other alphanumeric characters can be entered. To enter a blank or space, press the "9" button.

8. When the desired character is displayed, press the **MEMO** button to confirm the entry in this column and move to the next column. After having filled all of the 8 columns, press the **MEMO** button, for more than 1 second to confirm the entry.

RDS OPERATION

Now in use in many countries, RDS (Radio Data System) is a description of the station's programming hidden space in the FM signal. Your new receiver is equipped with RDS to assist in the selection of FM stations using station and network names, rather than broadcast frequencies. Additional RDS functions include the ability to search for programme types.

RADIO TEXT

Some RDS stations broadcast RADIO TEXT, which is additional information on the station and programme being broadcast. RADIO TEXT information appears as 'running' text in the display. RADIO TEXT is transmitted character by the radio station. As a result of that it may take some time until the entire text has been completely received.

RDS DISPLAY

When a receiver is tuned to an FM station that is transmitting RDS data, the Front Panel Information Display will automatically show the station name or RDS TEXT in place of the typical display of the station's broadcast frequency. To change the display, press the **DISP./RDS** button on the remote.

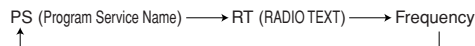

PROGRAMME TYPE (PTY) DISPLAY

The RDS system categorizes programmes according to their genre into different programme type (PTY) groups. To display the programme type information of the current station, press the **PTY** button in the TUNER MODE on the remote.

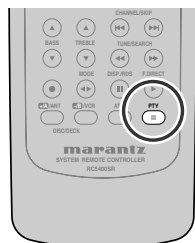

PTY AUTO SEARCH

Your receiver is equipped to automatically search for stations transmitting any of 29 different programme types. To search for a PTY, follow these procedures:

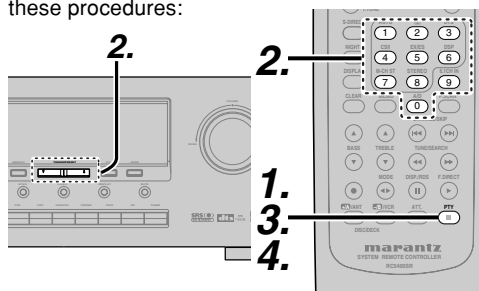

1. Press the **PTY** button in the TUNER MODE on the remote controller. The current station's PTY will be displayed, or the currently selected PTY group will be displayed in blinking if no station or RDS data is present.
2. To change to a new PTY type, press the **TUNING ▲** or **▼** button on the front panel or **numeric** buttons on the remote until the desired PTY is shown in the display.
3. Once the desired PTY group or type has been selected, press the **PTY** button while the display blink (approx. 5 seconds). The PTY Auto search will start, and the tuner will pause at each station broadcasting RDS PTY information corresponding to the selected choice.
4. To advance to the next RDS station with the desired PTY, press the **PTY** button again within 5 seconds.

NUMBER	DISPLAY	PROGRAMME TYPE
1	POP	Pop Music
2	ROCK	Rock Music
3	MOR	M. O. R. Music
4	LIGHT	Light classical
5	CLASSIC	Serious classical
6	NEWS	News
7	AFFAIR	Current Affairs
8	INFO	Information
9	SPORT	Sport
10	EDUCATE	Education
11	DRAMA	Drama
12	CULTURE	Culture
13	SCIENCE	Science
14	OTHERS	Varied
15	OTHER	Other Music
16	WEATHER	Weather
17	FINANCE	Finance
18	CHILDREN	Children's programmes
19	SOCIAL	Social Affairs
20	RELIGION	Religion
21	PHONE IN	Phone In
22	TRAVEL	Travel
23	HOBBIES	Hobbies
24	JAZZ	Jazz Music
25	COUNTRY	Country Music
26	NATION	National Music
27	OLDIES	Oldies Music
28	FOLK	Folk Music
29	DOCUMENT	Documentary

TROUBLESHOOTING

In case of trouble, check the following before calling for service:

1. Are the connections made properly ?
2. Are you operating the unit properly following user's guide ?
3. Are the power amplifiers and speaker working properly ?

If the unit does not operate properly, check items shown in the following table.
If your trouble cannot be recovered with the remedy actions listed in the following table, malfunction of the internal circuitry is suspected; immediately unplug the power cable and contact your dealer, nearest Marantz distributor or the Marantz Service Center in your country.

SYMPTOM	CAUSE	REMEDY
SR4400 cannot be turned up.	The power plug is not connected.	Connect the power plug to the outlet.
No sound and picture are output even when power is on.	Mute is on.	Cancel mute using the remote control unit.
	The input cable is not connected correctly.	See the connection diagram and connect the cables correctly.
	The master volume control is turned all the way down.	Adjust the master volume.
	The function selector position is wrong.	Select correct position.
Speaker does not outputting any sound.	The headphones are connected to the headphone jack.	Disconnect the headphones. (Speakers will not output sound when headphones are connected.)
Sound and pictures from other than equipment selected with the function selector.	Input cable connected incorrectly.	Connect the cable correctly by referring to the connection diagram.
Sound from the wrong channel is output from the speaker.	Speaker cable connected incorrectly.	Connect the cable correctly by referring to the connection diagram.
No sound is output from the center speaker.	The center speaker cable connection is incomplete.	Connect the cable correctly.
	STEREO has been selected for Surround mode.	When STEREO is selected for Surround mode, no sound will be output from the center speaker. Set another Surround mode.
	Center = NONE has been selected in SETUP mode.	Make the correct setting.
No sound is output from the surround speakers.	The surround speaker cable connection is incomplete.	Connect the cable correctly.
	STEREO has been selected for Surround mode.	When STEREO has been selected for Surround mode, no sound will be output from the surround speaker. Set another Surround mode.
	Surround = NONE has been selected in SETUP mode.	Make the correct setting.
No sound is output from the surround back	The surround back speaker cable connection is incomplete.	Connect the cable correctly.
	Surround mode is not EX/ES mode.	Set surround mode EX/ES.
	Surround back = NONE has been selected in SPEAKERS SIZE SETUP.	Make the correct setting.
Can not select EX/ES mode.	Surround back = NONE has been selected in SPEAKERS SIZE SETUP.	Make the correct setting.
	Input signal is incompatible.	Use 5.1 channel source.
Can not select Pro Logic II mode.	Input signal is incompatible.	Use 2 channel Dolby Digital input signal, PCM input signal or analog input signal.
Can not select Neo:6 mode.	Input signal is incompatible.	Use PCM input signal or analog input signal.

SYMPTOM	CAUSE	REMEDY
Can not select CSII mode.	Input signal is incompatible.	Use PCM input signal or analog input signal.
No output to Sub Woofer Out.	Sub-woofer = NONE has been selected in SETUP mode.	Select Sub-woofer = YES.
Noise is produced during DTS-encoded CD or laser disc play.	Analog has been selected for input.	Be sure to perform digital connection, select digital input, then play.
A specific channel does not produce output.	Nothing recorded on source.	Check the encoded channel on the source side.
FM or AM reception fails.	Antenna connection is incomplete.	Correctly connect the indoor FM and AM antennas to FM and AM antenna outlets.
Noise is heard during AM reception.	Reception is affected by other electrical fields.	Try changing location where the AM indoor antenna is set up.
Noise is heard during FM reception.	The radio waves from the broadcasting station are weak.	Install an FM outdoor antenna.
Cannot get programmed station when the PRESET button is pressed.	Preset data has been erased.	Disconnecting power plug for long periods of time will erase preset data. If that happens, input the preset data again.
Control with the remote control unit fails.	Batteries are consumed.	Replace all the batteries with new ones.
	Remote controller's function-key setting is wrong.	Select different position from which equipment will be controlled.
	The distance between this SR4400 and the remote commander is too far.	Move closer to this SR4400.
	Something is blocking SR4400 and the remote commander.	Remove offending object.

GENERAL MALFUNCTION

If the equipment malfunctions, this may be because an electrostatic discharge or AC line interference has corrupted the information in the equipment memory circuits. Therefore:

- disconnect the plug from the AC line supply
- after waiting at least three minutes, reconnect the plug to the AC line supply
- re-attempt to operate the equipment

HOW TO RESET THE UNIT

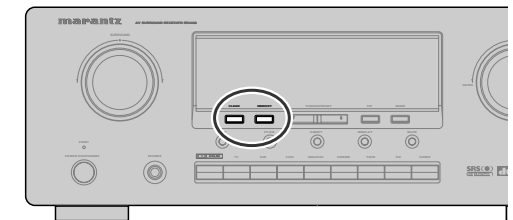

Should the operation or display seem to be abnormal, reset the unit with the following procedure.

The SR4400 is turned on, press and hold the **CLEAR** and **MEMORY** buttons simultaneously for 3 seconds or more.

Remember that the procedure will reset the settings of the function selector, Surround mode, delay time, TUNER PRESET etc., to their initial settings.

Memory backup

- In case a power outage occurs or the power cord is accidentally unplugged, the SR4400 is equipped with a backup function to prevent memory data such as the preset memory from being erased.

TECHNICAL SPECIFICATIONS

FM TUNER SECTION

Frequency Range	87.5 - 108.0 MHz
Usable Sensitivity	IHF 1.8 μ V/16.4 dBf
Signal to Noise Ratio	Mono/Stereo 76/72 dB
Distortion Mono/Stereo	Mono/Stereo 0.2/0.3 %
Stereo Separation	1 kHz 45 dB
Alternate Channel Selectivity	\pm 300 kHz 60 dB
Image Rejection	98 MHz 70 dB
Tuner Output Level	1 kHz, \pm 40 kHz Dev800 mV

AM TUNER SECTION

Frequency Range	531 - 1602 kHz
Signal to Noise Ratio	50 dB
Usable Sensitivity	Loop 500 μ V/m
Distortion	400 Hz, 30 % Mod. 0.5 %
Selectivity	\pm 18 kHz 70 dB

AUDIO SECTION

Power Output (20Hz – 20kHz / THD=0.08%)	
Front L&R	8ohms 80W/Ch
Center	8ohms 80W/Ch
Surround L&R	8ohms 80W/Ch
Surround Back	8ohms 80W/Ch
Front L&R	6ohms 95W/Ch
Center	6ohms 95W/Ch
Surround L&R	6ohms 95W/Ch
Surround Back	6ohms 95W/Ch
Input Sensitivity/Impedance	360 mV/ 47 kohms
Signal to Noise Ratio (Analog Input/Source Direct)	95 dB
Frequency Response	
(Analog Input/Source Direct)	8Hz-70kHz(\pm 3dB)
(Digital Input/96kHz PCM)	8Hz-45kHz(\pm 3dB)

VIDEO SECTION

Television Format	NTSC/PAL
Input Level/Impedance	1 Vp-p/ 75 ohms
Output Level/Impedance	1 Vp-p/ 75 ohms
Video Frequency Response	5 Hz to 8 MHz (– 1 dB)
Signal to Noise Ratio	60 dB

GENERAL

Power Requirement	AC 230 V 50 Hz
Power Consumption	325W
Weight	12.5 Kg

ACCESSORIES

Remote Control Unit RC5400SR	1
AAA-size batteries	2
FM Antenna	1
AM Loop Antenna	1
AC Power Cord	1
Registration Card	1
User Guide	1

Specifications subject to change without prior notice.

DIMENSION

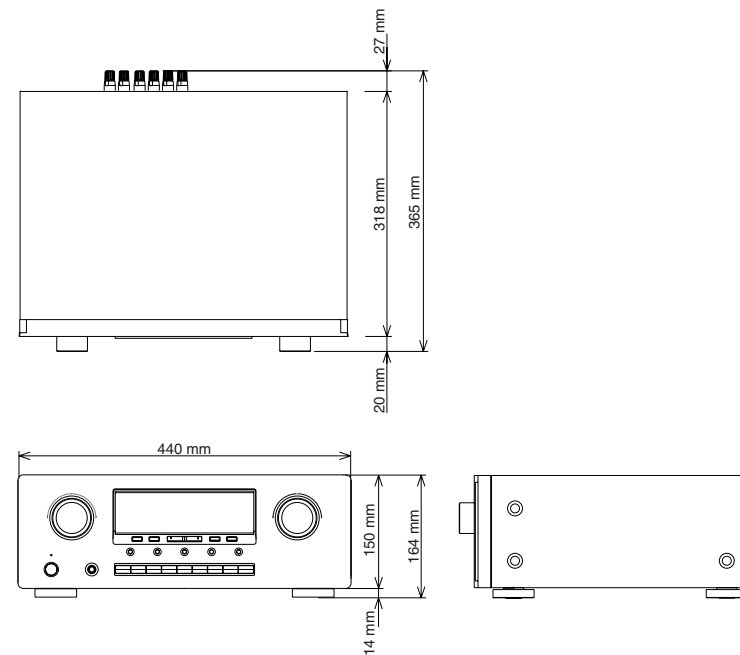

SETUP CODES

CD

Aiwa	0151, 0184
Burmester	0447
California Audio Labs	0056, 0330
Carver	0184, 0206, 0326, 0464
DKK	0027
Denon	0030
Emerson	0332
Fisher	0201, 0206
Garrard	0420, 0447
Genexxa	0059, 0332
Harman/Kardon	0184, 0200
Hitachi	0059
JVC	0099
Kenwood	0055, 0064, 0217
Krell	0184
LXI	0332
Linn	0184
Luxman	0062, 0120, 0293, 0354, 0355, 0457, 0459, 0510, 0516
MCS	0056
MTC	0447
Magnavox	0184, 0332
Marantz	0056, 0184, 0207, 1207, 0999,
Mission	0184
NAD	0046, 0326, 0343, 0747, 0748
NSM	0184
Nakamichi	0106, 0174, 0466, 0471, 0691
Nikko	0201
Onkyo	0128
Optimus	0027, 0059, 0064, 0172, 0206, 0332, 0447, 0464, 0495
Panasonic	0056, 0330
Parasound	0447
Philips	0184
Pioneer	0059, 0271, 0332, 0495
Polk Audio	0184
Proton	0184
QED	0184
Quasar	0056
RCA	0059, 0080, 0206, 0332, 0495, 0791
Realistic	0206, 0207, 0447
Rotel	0184, 0447
SAE	0184
Sansui	0184, 0332
Sanyo	0206

Scott	0332
Sears	0332
Sharp	0064, 0207
Sherwood	0207
Sonic Frontiers	0184
Sony	0027, 0212
Soundesign	0172
Tascam	0447
Teac	0201, 0207, 0420, 0447
Technics	0056, 0330
Toshiba	0046, 0326
Victor	0099
Wards	0080, 0184
Yamaha	0063, 0214
Yorx	0488

MD PLAYERS

Denon	1900
Kenwood	1708, 1853
Marantz	1207
Onkyo	1895
Optimus	1090
Pioneer	1090
Sharp	1888
Sherwood	1094
Sony	1517
Yamaha	1915

CDR

Marantz	0999
---------------	------

TAPE

Aiwa	0056, 0224
Carver	0056
Denon	0103
Garrard	0335, 0336
Harman/Kardon	0056, 0209
JVC	0271, 0300
Kenwood	0097
Magnavox	0056
Marantz	0056
NAD	0171
Onkyo	0162, 0309
Optimus	0054, 0247

Panasonic	0256
Philips	0056
Pioneer	0054, 0126, 0247
Polk Audio	0056
RCA	0054, 0247
Samsung	0418, 0419
Sansui	0056
Sony	0197, 0270, 0318
Teac	0307, 0335, 0336, 0418, 0419
Technics	0256
Victor	0300
Wards	0054
Yamaha	0121, 0124

SAT (DSS)

AlphaStar	0799
Echostar	0802, 1032
Expressvu	0802
General Instrument	0388, 0654, 0896
HTS	0802
Hitachi	0846
Hughes Network Systems	0776
JVC	0802
Jerrold	0388, 0654
Magnavox	0749, 0751
Memorex	0751
Next Level	0896
Panasonic	0728
Philips	0749, 0751, 1103
Primestar	0388, 0654
RCA	0170, 0419, 0593, 0882
Radio Shack	0896
Sony	0666
Star Choice	0896
Toshiba	0776, 0817
Uniden	0749, 0751
Zenith	0883

TV

AOC	0046, 0057
Admiral	0120, 0490
Aiko	0119
Akai	0057
Alaron	0206
Ambassador	0204
America Action	0207
Anam	0207

Audiovox	0119, 0207, 0478, 0650
Baysonic	0207
Belcor	0046
Bell & Howell	0043, 0181
Bradford	0207
Brockwood	0046
Broksonic	0263, 0490
CXC	0207
Candle	0057, 0083
Carnivale	0057
Carver	0081
Celebrity	0027
Cineral	0119, 0478
Citizen	0057, 0083, 0087, 0119
Concerto	0083
Contec	0207
Craig	0207
Crosley	0081
Crown	0207
Curtis Mathes	0043, 0057, 0074, 0078, 0081, 0083, 0087, 0120, 0172, 0181, 0193, 0478, 1174, 1374
Daewoo	0046, 0119, 0478, 0650, 0651
Daytron	0046
Denon	0172
Dumont	0044, 0046
Dwin	0747, 0801
Electroband	0027
Emerson	0046, 0181, 0204, 0205, 0206, 0207, 0263, 0490, 0650, 0651
Envision	0057
Fisher	0181
Fujitsu	0206, 0710
Funai	0206, 0207
Futuretech	0207
GE	0074, 0078, 0120, 0205, 0478, 1174, 1374
Gibraltar	0044, 0046, 0057
GoldStar	0046, 0057, 0083, 0205
Gradiente	0080, 0083
Grunpy	0206, 0207
Hallmark	0205
Harley Davidson	0206
Harman/Kardon	0081
Harvard	0207
Hitachi	0043, 0083, 0172
Infinity	0081
Inteq	0044
JBL	0081
JCB	0027

JVC	0080	Sampo	0057	Audiovox	0064	Magnin	0267
KEC	0207	Samsung	0046, 0057, 0083, 0087, 0205	Beaumarck	0267	Marantz	0062, 0108, 1408
KTV	0057, 0207	Sansei	0478	Bell & Howell	0131	Marta	0064
Kenwood	0046, 0057	Sansui	0490	Broksonic	0148, 0211, 0236, 0506	Matsushita	0062, 0189
LG	0083	Sanyo	0181	CCE	0099, 0305	Memorex	0027, 0062, 0064, 0066, 0074, 0075, 0131, 0189, 0236, 0267, 0506, 1064, 1189, 1289
LXI	0074, 0081, 0181, 0183, 0205	Scimitsu	0046	Calix	0064	Minolta	0069
Logik	0043	Scotch	0205	Canon	0062	Mitsubishi	0070, 0075, 0094
Luxman	0083	Scott	0046, 0205, 0206, 0207, 0263	Carver	0108	Motorola	0062, 0075
MGA	0046, 0057, 0177, 0205	Sears	0074, 0081, 0083, 0181, 0183, 0205, 0206	Cineral	0305	Multitech	0027, 0099
MTC	0046, 0057, 0083, 0087	Semivox	0207	Colt	0099	NAD	0085
Magnavox	0057, 0081, 0206, 1281	Semp	0183	Craig	0064, 0074, 0099, 0267	NEC	0094, 0131
Majestic	0043	Sharp	0120, 0192, 0715	Curtis Mathes	0062, 0087, 0189	Nikko	0064
Marantz	0057, 0081, 1581	Shogun	0046	Cybernex	0267	Noblex	0267
Matsushita	0277	Signature	0043	Daewoo	0072, 0305	Olympus	0062
Megatron	0172, 0205	Sony	0027	Denon	0069	Optimus	0064, 0075, 0085, 0131, 0189, 0459, 1075, 1089, 1189, 1289
Memorex	0043, 0083, 0177, 0181, 0205, 0206, 0277, 0490	Soundesign	0205, 0206, 0207	Dynatech	0027	Orion	0211, 0236, 0506
Midland	0044, 0074, 0078	Starlite	0207	Electrohome	0064	Panasonic	0062, 0189, 0252, 0643, 1089, 1189, 1289
Mitsubishi	0046, 0120, 0177, 0205	Supreme	0027	Electrohome	0064	Penney	0062, 0064, 0069, 0267
Motorola	0120	Sylvania	0057, 0081	Emerex	0059	Pentax	0069
Multitech	0207	TMK	0083, 0204, 0205	Emerson	0027, 0064, 0070, 0148, 0211, 0236, 0305, 0506	Philco	0062, 0236, 0506
NAD	0183, 0193, 0205	TNCi	0044	Fisher	0074, 0131	Philips	0062, 0108, 0645, 1108, 1208
NEC	0046, 0057, 0083	Tandy	0120	Fuji	0062	Pilot	0064
NTC	0119	Technics	0078, 0277	Funai	0027	Pioneer	0085, 0094
Nikko	0057, 0119, 0205	Technol Ace	0206	GE	0062, 0075, 0087, 0267	Polk Audio	0108
Onwa	0207	Techwood	0078, 0083	Garrard	0027	Profitronic	0267
Optimus	0181, 0193, 0277	Teknika	0043, 0046, 0081, 0083, 0087, 0119, 0177, 0206, 0207	Go Video	0459	Proscan	0087
Optonica	0120, 0192	Telefunken	0083	GoldStar	0064	Protec	0099
Orion	0206, 0263, 0490	Toshiba	0087, 0181, 0183, 1283	Gradiente	0027	Pulsar	0066
Panasonic	0078, 0277	Vector Research	0057	Hi-Q	0074	Quasar	0062, 0189, 1189
Penney	0046, 0057, 0074, 0078, 0083, 0087, 0183, 0205, 1374	Victor	0080	Harley Davidson	0027	RCA	0062, 0069, 0075, 0085, 0087, 0267
Philco	0046, 0057, 0081, 0172, 0490	Vidikron	0081	Harman/Kardon	0108	Radio Shack	0027, 1064
Philips	0081	Vidtech	0046, 0205	Harwood	0099	Radix	0064
Pilot	0046, 0057	Wards	0043, 0046, 0057, 0081, 0083, 0192, 0205, 0206	Hitachi	0027, 0069	Randex	0064
Pioneer	0193, 0706	White Westinghouse	0490, 0650, 0651	Hughes Network Systems	0069	Realistic	0027, 0062, 0064, 0074, 0075, 0131
Portland	0046, 0119	Yamaha	0046, 0057	JVC	0094	ReplayTV	0641, 0643
Prism	0078	Zenith	0043, 0044, 0119, 0490, 0651	KEC	0064, 0305	Runco	0066
Proscan	0074			KLH	0099	STS	0069
Proton	0205			Kenwood	0094	Samsung	0072, 0267
Pulsar	0044, 0046			Kodak	0062, 0064	Sanky	0066, 0075
Quasar	0078, 0192, 0277			LXI	0064	Sansui	0027, 0094, 0236, 0506
RCA	0046, 0074, 0078, 0117, 0120, 0706, 1074, 1174, 1274, 1374, 1474			Lloyd's	0027	Sanyo	0074, 0131, 0267
Radio Shack	0046, 0057, 0074, 0083, 0181, 0192, 0205, 0207			Logik	0099	Scott	0070, 0072, 0148, 0211
Realistic	0046, 0057, 0083, 0181, 0192, 0205, 0207			MEI	0062	Sears	0027, 0062, 0064, 0069, 0074, 0131
Runco	0044, 0057, 0630			MGA	0070, 0267	Semp	0072
SSS	0046, 0207			MGN Technology	0267	Sharp	0075
				MTC	0027, 0267	Shintom	0099
				Magnasonic	0305		
				Magnavox	0027, 0062, 0066, 0108		

VCR

Admiral	0075, 0236
Adventura	0027
Aiko	0305
Aiwa	0027, 0064
America Action	0305
American High	0062
Asha	0267

Shogun	0267
Singer	0099
Sony	0027, 0059, 0062, 1059
Sylvania	0027, 0062, 0070, 0108
Symphonic	0027
TMK	0267
Teac	0027
Technics	0062, 0189
Teknika	0027, 0062, 0064
Thomas	0027
Tivo	0645
Toshiba	0070, 0072
Totevision	0064, 0267
Unitech	0267
Vector	0072
Video Concepts	0072
Videosonic	0267
Wards	0027, 0062, 0069, 0074, 0075, 0087, 0099, 0108, 0267
White Westinghouse	0099, 0236, 0305
XR-1000	0027, 0062, 0099
Zenith	0027, 0066, 0236, 0506

DVD

Aiwa	0668
Apex	0699
Denon	0517, 0661
Fisher	0697
GE	0549
Harman/Kardon	0609
Hitachi	0691
Hiteker	0699
JVC	0585, 0650
Kenwood	0561, 0709
Magnavox	0530, 0702
Marantz	0566
Mitsubishi	0548
Onkyo	0530, 0654
Optimus	0598
Oritron	0678
Panasonic	0517, 0659
Philips	0530, 0566
Pioneer	0552, 0598, 0659
Proscan	0549
RCA	0549, 0598
Samsung	0600
Sharp	0657
Sony	0560
Technics	0517
Theta Digital	0598
Toshiba	0530
Yamaha	0517, 0572
Zenith	0530, 0618

www.marantz.com

You can find your nearest authorized distributor or dealer on our website.

JAPAN	Marantz Japan, Inc.	35-1 Sagami Ohno 7-Chome, Sagamihara-shi, Kanagawa 228-8505, Japan
U.S.A.	Marantz America, Inc.	1100 Maplewood Drive, Itasca, IL 60143, U.S.A.
EUROPE	Marantz Europe B.V.	P.O. Box 8744, 5605 LS Eindhoven, The Netherlands

Manufactured under license from Dolby Laboratories. "Dolby", "Pro Logic", and the double-D symbol are trademarks of Dolby Laboratories.
"DTS", "DTS-ES Extended Surround" and "Neo:6" are trademarks of Digital Theater Systems, Inc.

marantz[®] is a registered trademark.

