

marantz®

Model SR6300 User Guide

AV Surround Receiver

ENGLISH

WARRANTY

For warranty information, contact your local Marantz distributor.

RETAIN YOUR PURCHASE RECEIPT

Your purchase receipt is your permanent record of a valuable purchase. It should be kept in a safe place to be referred to as necessary for insurance purposes or when corresponding with Marantz.

IMPORTANT

When seeking warranty service, it is the responsibility of the consumer to establish proof and date of purchase. Your purchase receipt or invoice is adequate for such proof.

FOR U.K. ONLY

This undertaking is in addition to a consumer's statutory rights and does not affect those rights in any way.

FRANÇAIS

GARANTIE

Pour des informations sur la garantie, contacter le distributeur local Marantz.

CONSERVER L'ATTESTATION D'ACHAT

L'attestation d'achat est la preuve permanente d'un achat de valeur. La conserver en lieu sûr pour s'y reporter aux fins d'obtention d'une couverture d'assurance ou dans le cadre de correspondances avec Marantz.

IMPORTANT

Pour l'obtention d'un service couvert par la garantie, il incombe au client d'établir la preuve de l'achat et d'en corroborer la date. Le reçu ou la facture constituent des preuves suffisantes.

DEUTSCH

GARANTIE

Bei Garantiefragen wenden Sie sich bitte an Ihren Marantz-Händler.

HEBEN SIE IHRE QUITTING GUT AUF

Die Quittung dient Ihnen als bleibende Unterlage für Ihren wertvollen Einkauf. Das Aufbewahren der Quittung ist wichtig, da die darin enthaltenen Angaben für Versicherungswecke oder bei Korrespondenz mit Marantz angeführt werden müssen.

WICHTIG!

Bei Garantiefragen muß der Kunde eine Kaufunterlage mit Kaufdatum vorlegen. Ihren Quittung oder Rechnung ist als Unterlage ausreichend.

NEDERLANDS

GARANTIE

Voor inlichtingen omtrent garantie dient u zich tot uw plaatselijke Marantz.

UW KWITANTIE, KASSABON E.D. BEWAREN

Uw kwitantie, kassabon e.d. vormen uw bewijs van aankoop van een waardevol artikel en dienen op een veilige plaats bewaard te worden voor evt, verwijzing bijv, in verbend met verzekering of bij correspondentie met Marantz.

BELANGRIJK

Bij een evt, beroep op de garantie is het de verantwoordelijkheid van de consument een gedateerd bewijs van aankoop te tonen. Uw kassabon of factuur zijn voldoende bewijs.

ESPAÑOL

GARANTIA

Para obtener información acerca de la garantía póngase en contacto con su distribuidor Marantz.

GUARDE SU RECIBO DE COMPRA

Su recibo de compra es su prueba permanente de haber adquirido un aparato de valor. Este recibo deberá guardarlo en un lugar seguro y utilizarlo como referencia cuando tenga que hacer uso del seguro o se ponga en contacto con Marantz.

IMPORTANTE

Cuando solicite el servicio otorgado por la garantía el usuario tiene la responsabilidad de demostrar cuándo efectuó la compra. En este caso, su recibo de compra será la prueba apropiada.

ITALIANO

GARANZIA

L'apparecchio è coperto da una garanzia di buon funzionamento della durata di un anno, o del periodo previsto dalla legge, a partire dalla data di acquisto comprovata da un documento attestante il nominativo del Rivenditore e la data di vendita. La garanzia sarà prestata con la sostituzione o la riparazione gratuita delle parti difettose.

Non sono coperti da garanzia difetti derivanti da uso improprio, errata installazione, manutenzione effettuata da personale non autorizzato o, comunque, da circostanze che non possano riferirsi a difetti di funzionamento dell'apparecchio. Sono inoltre esclusi dalla garanzia gli interventi inerenti l'installazione e l'allacciamento agli impianti di alimentazione.

Gli apparecchi verranno riparati presso i nostri Centri di Assistenza Autorizzati. Le spese ed i rischi di trasporto sono a carico del cliente.

La casa costruttrice declina ogni responsabilità per danni diretti o indiretti provocati dalla inosservanza delle prescrizioni di installazione, uso e manutenzione dettagliate nel presente manuale o per guasti dovuti ad uso continuato a fini professionali.

PORTUGUÊS

GARANTIA

Para informações sobre a garantia, contactar o distribuidor Marantz local.

GUARDAR O RECIBO DE COMPRA

O recibo é o registo permanente da compra que fez. Deve ser guardado num local seguro, para ser apresentado em questões relacionadas com o seguro ou para quando tiver de contactar a Marantz.

IMPORTANTE

Quando procurar assistência técnica ao abrigo da garantia, é da responsabilidade do consumidor estabelecer a prova e data de compra.

O recibo é prova adequada.

SVENSKA

GARANTI

För information om garantin, kontakta Marantz lokalagent.

SPAR KVITTOT

Kvittot är ett inköpsbevis på en värdefull vara. Det skall förvaras säkert och hänvisas till vid försäkringsfall eller vidkorrespondens mod Marantz.

VIKTIGT

Fö att garantin skall gälla är det kundens sak att framställa bevis och datum om köpet. Kvitto eller faktura är tillräckligt bevis för detta.

DANSK

GARANTI

Henvend dem til Deres MARANTZ-forhandler angående information om garantien.

GEM DERES KVITTERING

Deres købskvittering er Deres varige bevis på et dyrt køb. Den bør gemmes godt og anvendes som bevis, hvis De vil tegne en forsikring, eller hvis De kommunikerer med Marantz.

VIGTIGT

Det påhviler forbrugeren at skaffe bevis for købet og købsdatoen, hvis han eller hun ønsker garantiservice. Deres købskvittering eller faktura er et fuldgdydigt bevis herpå.

CE MARKING

- English**
The SR6300 is in conformity with the EMC directive and low-voltage directive.
- Français**
Le SR6300 est conforme à la directive EMC et à la directive sur les basses tensions.
- Deutsch**
Das Modell SR6300 entspricht den EMC-Richtlinien und den Richtlinien für Niederspannungsgeräte.
- Nederlands**
De SR6300 voldoet aan de EMC eisen en de vereisten voor laag-voltage.
- Español**
El SR6300 está de acuerdo con las normas EMC y las relacionadas con baja tensión.
- Italiano**
Il SR6300 è conforme alle direttive CEE ed a quelle per i bassi voltaggi.
- Português**
O SR6300 conforma com as diretrizes EMC e de baixa voltagem.
- Svenska**
SR6300 är tillverkad i enlighet med EMC direktiven och direktiven för lågvoltsutrusning.
- Dansk**
Model SR6300 er i overensstemmelse med EMC-direktivet og direktivet om lavspænding.

English

To ventilate the unit, do not install the unit in a rack or bookshelf, and note the followings.

- Do not touch the top of the enclosure during operation.
- Do not block the openings in the enclosure during operation.
- Do not insert objects beneath the unit.
- Do not block the ventilation slots at the top of the unit.
- Do not place anything about 1 meter above the top panel.
- Make a space of about 0.2 meter around the unit.

Français

Pour que l'appareil puisse être correctement ventilé, ne pas l'installer dans un meuble ou une bibliothèque et respecter ce qui suit.

- Ne pas toucher le dessus du coffret.
- Ne pas obstruer les ouïes de ventilation du coffret pendant le fonctionnement.
- Ne placer aucun objet sous l'appareil.
- Ne pas obstruer les ouïes de ventilation du panneau supérieur. Ne placer aucun objet à moins d'un mètre environ du panneau supérieur.
- Veiller à ce qu'aucun objet ne soit à moins de 0,2 mètre des côtés de l'appareil.

Deutsch

Um eine einwandfreie Belüftung des Geräts zu gewährleisten, darf das Gerät nicht in einem Gestell oder Bücherregal aufgestellt werden; die folgenden Punkte sind besonders zu beachten:

- Während des Betriebs das Oberteil des Gehäuses nicht berühren.
- Während des Betriebs die Öffnungen im Gehäuse nicht blockieren.
- Keine Gegenstände in das Gerät einführen.
- Die Belüftungsschlitze an der Oberseite des Geräts dürfen nicht blockiert werden. Darauf achten, daß über dem Gerät ein Freiraum von mindestens 1 meter vorhanden ist.
- Auf allen Geräteseiten muß ein Zwischenraum von ungefähr 0,2 meter vorhanden sein.

Nederlands

Installeer het toestel niet in een rek of boekenkast waar de ventilatie mogelijk wordt gehinderd. Let tevens op de volgende punten:

- Raak de bovenkant van het toestel niet aan als het in gebruik is.
- Blokkeer de openingen van het toestel niet als het in gebruik is.
- Plaats geen onderwerpen onder het toestel.
- Blokkeer de ventilatie-openingen aan de bovenkant van het toestel niet. Zorg dat er tenminste 1 meter vrije ruimte boven het toestel is.
- Zorg dat er 0,2 meter vrije ruimte rond het toestel is.

Español

Para ventilar la unidad no la instale en una estantería ni estante para libros, y tenga en cuenta lo siguiente:

- No toque la parte superior de la caja durante el funcionamiento.
- No tape las ranuras en la caja durante el funcionamiento
- No ponga objetos debajo de la unidad.
- No tape las ranuras de ventilación de la parte superior de la unidad. No ponga nada a menos de 1 metro por encima del panel superior.
- Deje un espacio de unos 0,2 metro alrededor de la unidad.

Italiano

Perché l'unità possa essere sempre ben ventilata, non installarla in scaffali o librerie e tenere presente quanto segue.

- Non toccare la parte superiore del rivestimento durante il funzionamento.
- Non bloccare le aperture sul rivestimento durante il funzionamento.
- Non inserire oggetti al di sotto dell'unità.
- Non bloccare le fessure di ventilazione sopra l'unità. Non posare nulla per circa un metro sopra il pannello superiore.
- Lasciare 0,2 metro liberi tutto intorno l'unità.

Português

Para ventilar o aparelho, não instalá-lo dentro duma estante ou algo similar, e observar as seguintes recomendações:

- Não tocar a parte superior do aparelho durante a operação.
- Não bloquear as aberturas do aparelho durante a operação.
- Não inserir objectos debaixo do aparelho.
- Não bloquear as aberturas de ventilação na parte de cima do aparelho. Deixar um espaço completamente livre de cerca de 1 metro acima do painel superior.
- Deixar um espaço de cerca de 0,2 metro ao redor do aparelho.

Svenska

För att ventilera enheten, ställ den inte i ett ställ eller bokhylla och tänk på följande.

- Vidrör inte ytterhöljets ovansida under pågående drift.
- Blockera inte öppningarna i ytterhöljet under pågående drift.
- Stick inte in föremål under enheten.
- Blockera inte ventiltionshålén ovanpå enheten. Placera inte någonting närmare än 1 meter ovanför apparaten eller enheten.
- Se till att det finns omkring 0,2 meter fri plats runt omkring enheten.

Dansk

Anbring ikke apparatet i et rack eller en boghylde, da dette kan bloke luftcirkulationen omkring apparatet. Iagttag ligeledes følgende:

- Berør ikke oversiden af kabinettet under anvendelsen.
- Bloker ikke åbningerne i kabinettet under anvendelsen.
- Stik ikke genstande ind under apparatet.
- Bloker ikke ventilationsåbningerne ovenpå apparatet. Anbring ikke noget nærmere end 1 m over apparatets overside.
- Sørg for, at der er et frit område på omkring 0,2 m omkring apparatet.

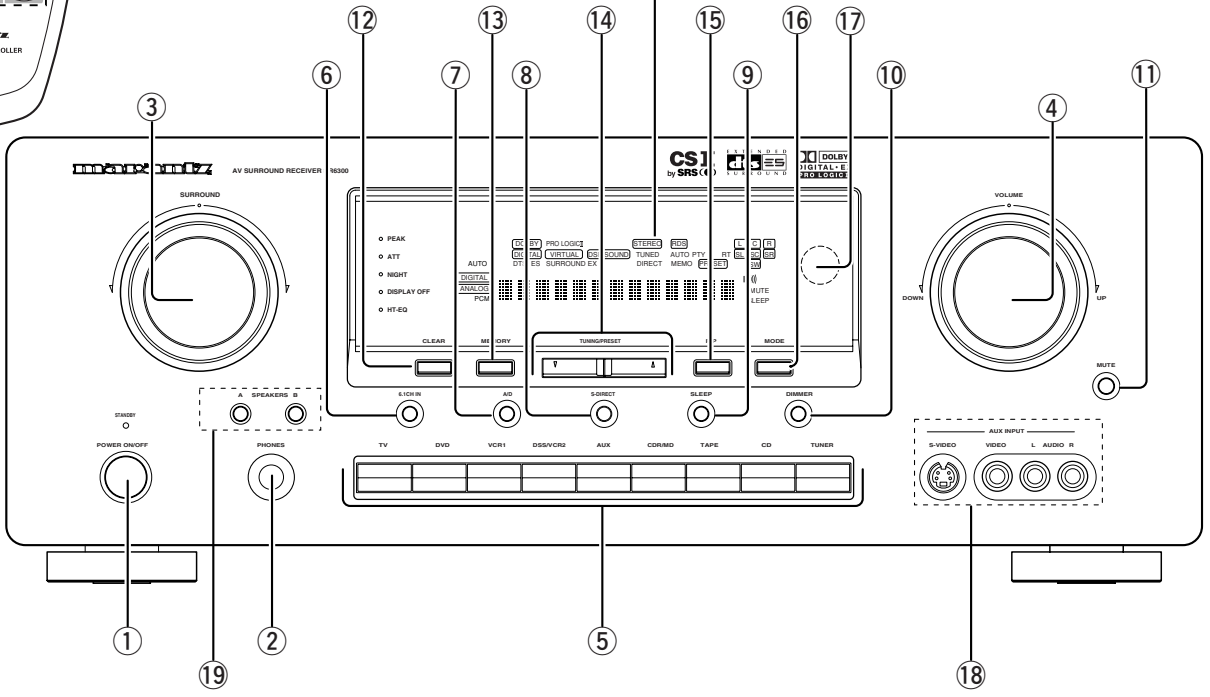
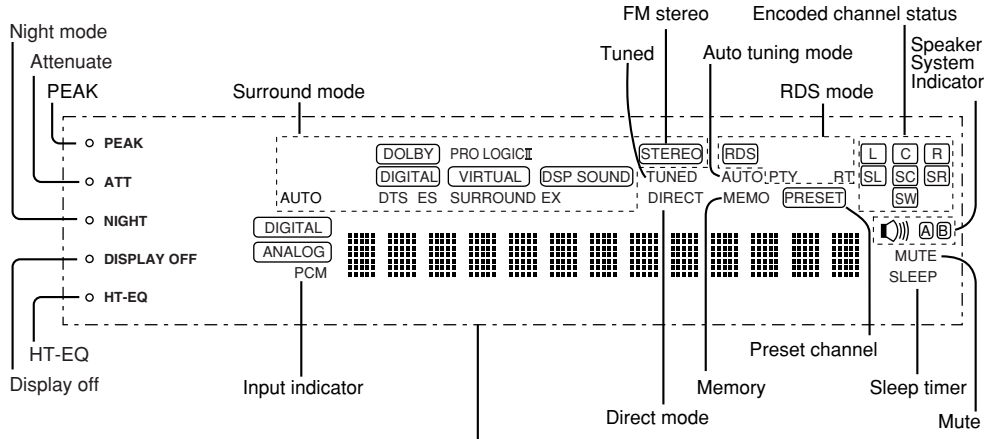
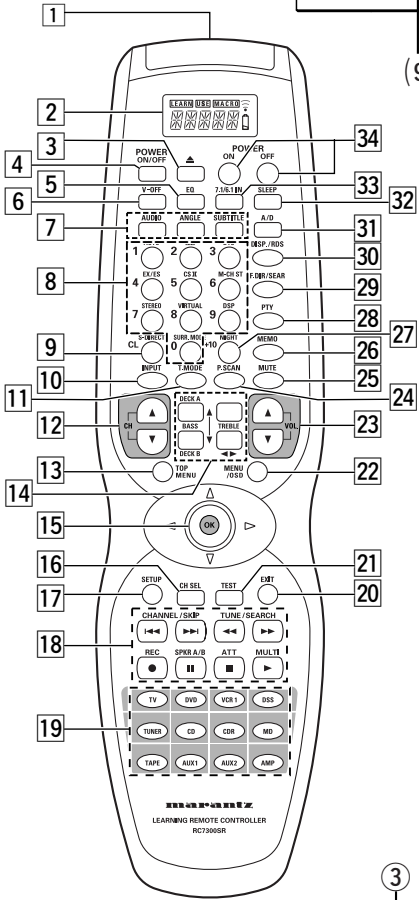
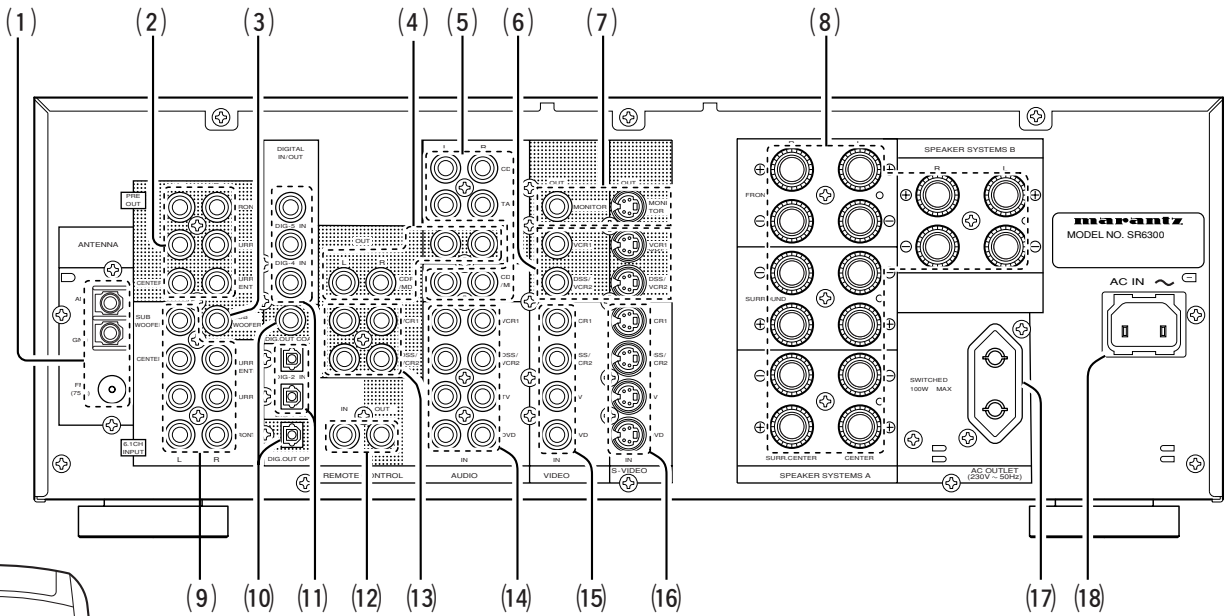

TABLE OF CONTENTS

FOREWORD	2	ON SCREEN DISPLAY INFORMATION	24
PRECAUTIONS	2	REMOTE CONTROLLER OPERATION	25
INSTALLATION	2	CONTROLLING THE SR6300	25
INTRODUCTION	3	CONTROLLING MARANTZ COMPONENTS	25
DESCRIPTION	3	LEARN MODE	27
FEATURES	4	MACRO MODE	28
FRONT PANEL FEATURES	5	SURROUND MODE	32
REAR PANEL CONNECTIONS	6	TROUBLE SHOOTING	36
REMOTE CONTROLER RC7300SR	7	TECHNICAL SPECIFICATIONS	38
NAMES AND FUNCTIONS	7	DIMENSION	38
REMOTE CONTROL RANGE	9		
LOADING BATTERIES	9		
GENERAL INFROMATION OF RC7300SR TO SR6300	9		
CONNECTIONS	10		
SPEAKER PLACEMENT	10		
CONNECTING SPEAKERS	11		
CONNECTING AUDIO COMPONENTS	12		
CONNECTING VIDEO COMPONENTS	13		
ADVANCED CONNECTING	14		
CONNECTING REMOTE CONTROL JACKS	14		
CONNECTING THE ANTENNA TERMINALS	15		
SETUP	16		
ON SCREEN DISPLAY MENU SYSTEM	16		
INPUT SETUP (ASSIGNABLE DIGITAL INPUT)	17		
SPEAKER SETUP	17		
PREFERENCE	19		
SURROUND	19		
PL II (PRO LOGIC II) MS PARAMETER	19		
CS2 (CIRCLE SURROUND II) PARAMETER	20		
6.1 CH INPUT LEVEL	20		
BASIC OPERATION	21		
LISTENING TO THE TUNER	21		
RDS OPERATION	22		
PLAYBACK OPERATION	23		
TV AUTO ON/OFF FUNCTION	23		
SETTING THE SLEEP TIMER	23		
ADJUSTING THE SURROUND LEVEL	23		

FOREWORD

This section must be read before any connection is made to the mains supply.

WARNINGS

- Do not expose the equipment to rain or moisture.
- Do not remove the cover from the equipment.
- Do not insert anything into the equipment through the ventilation holes.
- Do not handle the mains lead with wet hands.
- Do not cover the ventilation with any items such as tablecloths, newspapers, curtains, etc.
- No naked flame sources, such as lighted candles, should be placed on the equipment.
- When disposing of used batteries, please comply with governmental regulations or environmental public instruction's rules that apply in your country or area.

EQUIPMENT MAINS WORKING SETTING

Your Marantz product has been prepared to comply with the household power and safety requirements that exist in your area. SR6300 can be powered by 230 V AC only.

COPYRIGHT

Recording and playback of any material may require consent. For further information refer to the following:

- Copyright Act 1956
- Dramatic and Musical Performers Act 1958
- Performers Protection Acts 1963 and 1972
- any subsequent statutory enactments and orders

ABOUT THIS USER GUIDE

Refer to the figures on page iii of this user guide. The numbers on the figures correspond to those in the text. All references to the connections and controls that are printed in **BOLD** type are as they appear on the unit.

PRECAUTIONS

The following precautions should be taken when operating the equipment.

GENERAL PRECAUTIONS

When siting the equipment ensure that:

- the ventilation holes are not covered;
- air is allowed to circulate freely around the equipment
- it is on a vibration free-surface;
- it will not be exposed to interference from an external source;
- it will not be exposed to excessive heat, cold, moisture or dust;
- it will not be exposed to direct sunlight;
- it will not be exposed to electrostatic discharges

Never place heavy objects on the equipment.

If a foreign body or water does enter the equipment, contact your nearest dealer or service center.

Do not pull out the plug by pulling on the mains lead, hold the plug.

It is advisable when leaving the house, or during a thunderstorm, to disconnect the equipment from the mains supply.

PRECAUTIONS IN CONNECTION

- Be sure to unplug the power cable from the AC outlet or turn off the POWER switch before proceeding with any connection.
- Connect one cable at a time observing the "input" and "output". This will avoid any cross connection between channels and signal inputs and outputs.
- Insert the plugs securely. Incomplete connection may result in noise.
- Prior to connecting other audio and video equipment to the SR6300, please read their owner's manuals.

INSTALLATION

If this unit or another electronic device incorporating a microcomputer is used at the same time with the tuner or television, picture disturbance or noise may occur. In such a case, install the unit according to the following guide points.

- Separate the unit as far as possible from the television.
- Place the antenna wire for the tuner or TV apart from the power cable and audio and video connection cables of this unit.
- Since the phenomenon is likely to occur when using an indoor antenna and/or 300-ohm feeder wire, we recommend using an outdoor antenna and 75-ohm coaxial cable.

CAUTIONS ON INSTALLATION

For heat dispersal, leave at least 20 cm/8 inches of space between the top, back and sides of this unit and the wall or other components.

- Do not obstruct the ventilation holes.

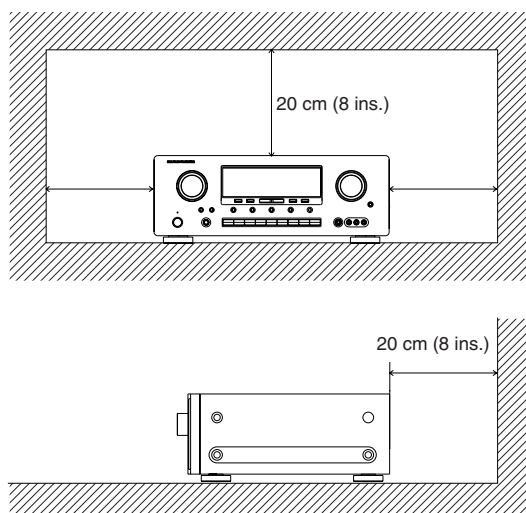

INTRODUCTION

Thank you for purchasing the Marantz SR6300 DTS/Dolby Digital Surround receiver.

This remarkable component has been engineered to provide you with many years of home theater enjoyment.

Please take a few minutes to read this manual thoroughly before you connect and operate the SR6300.

As there are a number of connection and configurations options, you are encouraged to discuss your own particular home theater setup with your Marantz A/V specialist dealer.

DESCRIPTION



DTS was introduced in 1994 to provide 5.1 channels of discrete digital audio into home theater systems.

DTS brings you premium quality discrete multi-channel digital sound to both movies and music.

DTS is a multi-channel sound system designed to create full range digital sound reproduction.

The no compromise DTS digital process sets the standard of quality for cinema sound by delivering an exact copy of the studio master recordings to neighborhood and home theaters.

Now, every moviegoer can hear the sound exactly as the moviemaker intended.

DTS can be enjoyed in the home for either movies or music on of DVD's, LD's, and CD's.

"DTS" and "DTS Digital Surround" are registered trademarks of Digital Theater Systems, Inc.



The advantages of discrete multichannel systems over matrix are well known.

But even in homes equipped for discrete multichannel, there remains a need for high-quality matrix decoding. This is because of the large library of matrix surround motion pictures available on disc and on VHS tape; and analog television broadcasts.

The typical matrix decoder of today derives a center channel and a mono surround channel from two-channel matrix stereo material. It is better than a simple matrix in that it includes steering logic to improve separation, but because of its mono, band-limited surround it can be disappointing to users accustomed to discrete multichannel.

Neo 6 offers several important improvements as follow,

- Neo 6 provides up to six full-band channels of matrix decoding from stereo matrix material. Users with 6.1 and 5.1 systems will derive six and five separate channels, respectively, corresponding to the standard home-theater speaker layouts.
- Neo 6 technology allows various sound elements within a channel or channels to be steered separately, and in a way which follows naturally from the original presentation.
- Neo 6 offers a music mode to expand stereo nonmatrix recordings into the five- or six-channel layout, in a way which does not diminish the subtlety and integrity of the original stereo recording.



DTS-ES Extended Surround is a new multi-channel digital signal format developed by Digital Theater Systems Inc. While offering high compatibility with the conventional DTS Digital Surround format, DTS-ES Extended Surround greatly improves the 360-degree surround impression and space expression thanks to further expanded surround signals. This format has been used professionally in movie theaters since 1999.

In addition to the 5.1 surround channels (FL, FR, C, SL, SR and LFE), DTS-ES Extended Surround also offers the SC (Surround Center) channel for surround playback with a total of 6.1 channels. DTS-ES Extended Surround includes two signal formats with different surround signal recording methods, as DTS-ES Discrete 6.1 and DTS-ES Matrix 6.1.

"DTS", "DTS-ES Extended Surround" and "Neo:6" are trademarks of Digital Theater Systems, Inc.



Dolby Digital identifies the use of Dolby Digital (AC-3) audio coding for such consumer formats as DVD and DTV. As with film sound, Dolby Digital can provide up to five full-range channels for left, center, and right screen channels, independent left and right surround channels, and a sixth (".1") channel for low-frequency effects.

Dolby Surround Pro Logic II is an improved matrix decoding technology that provides better spatiality and directionality on Dolby Surround program material; provides a convincing three-dimensional soundfield on conventional stereo music recordings; and is ideally suited to bring the surround experience to automotive sound. While conventional surround programming is fully compatible with Dolby Surround Pro Logic II decoders, soundtracks will be able to be encoded specifically to take full advantage of Pro Logic II playback, including separate left and right surround channels. (Such material is also compatible with conventional Pro Logic decoders.)

Dolby Digital EX creates six full-bandwidth output channels from 5.1-channel sources. This is done using a matrix decoder that derives three surround channels from the two in the original recording. For best results, Dolby Digital EX should be used with movies soundtracks recorded with Dolby Digital Surround EX.

Manufactured under license from Dolby Laboratories. "Dolby", "Pro Logic", and the double-D symbol are trademarks of Dolby Laboratories.



Circle Surround II (CS-II) is a powerful and versatile multi-channel technology. CS-II is designed to enable up to 6.1 multi-channel surround sound playback from mono, stereo, CS encoded sources and other matrix encoded sources. In all cases the decoder extends it into 6 channels of surround audio and a LFE/subwoofer signal. The CS-II decoder creates a listening environment that places the listener "inside" music performances and dramatically improves both hi-fi audio conventional surround-encoded video material. CS-II provides composite stereo rear channels to greatly improve separation and image positioning – adding a heightened sense of realism to both audio and A/V productions.

CS-II is packed with other useful feature like dialog clarity (SRS Dialog) for movies and cinema-like bass enrichment (TruBass). CS-II can enable the dialog to become clearer and more discernable in movies and it enables the bass frequencies contained in the original programming to more closely achieve low frequencies – overcoming the low frequency limitations of the speakers by full octave.

SRS Circle Surround II, SRS Dialog, SRS TruBass, SRS and  symbol are trademarks of SRS Labs, Inc. SRS Circle Surround II, SRS Dialog and SRS TruBass technology are incorporated under license from SRS Labs, Inc.

FEATURES

BUILT-IN 6 CHANNEL POWER AMPLIFIER

100 watts to each of the six main channels ; the power amp section features an advanced, premium high- storage power supply capacitors, and fully discrete output stages housed in cast aluminum heat sinks .

192 kHz/24-BIT D/A CONVERTER FOR ALL CHANNELS

High performance digital circuitry with 192 kHz / 24-bit D/A converter for all 7 channels.

DTS-ES

DTS-ES decoder built in to decode the impeccable 6.1-channel discrete digital audio from DTS-ES encoded DVD-Video discs, DVD-Audio discs and CDs.

DOLBY DIGITAL EX

Dolby Digital EX decoder built in to create six full-band width output channels from the 5.1-channel digital audio of DVDs, Digital TV, HDTV, satellite broadcasts and other sources.

DOLBY PRO LOGIC II

Dolby Pro Logic II decoder provides better spatiality and directionality on Dolby Surround program material and provides a convincing three-dimensional sound field on conventional stereo music recordings.

DTS-NEO6

DTS-Neo6 decoder built in to decode 6.1-channel surround sound from any stereo material.

CIRCLE SURROUND II

CIRCLE SURROUND II decoder built in to decode 6.1-channel surround sound from any stereo or passive matrix-encoded material.

SOURCE DIRECT MODE

Source Direct mode bypasses, tone controls and bass management for purest audio quality.

6.1 CHANNEL PRE-AMP OUTPUTS

6.1 channel pre-amp outputs for connection to external components such as a subwoofer and external power amplifiers.

6.1CH DIRECT INPUT

6.1ch direct inputs accommodate future multi-channel sound formats or an external digital decoder.

5 DIGITAL INPUTS AND 2 DIGITAL OUTPUTS

5 Digital inputs for connection to other sources, such as DVD, DSS, CD, CD-R or MD.

2 Digital outputs for connection to CD-R or MD.

30 STATION RANDOM ACCESS PRESET TUNING

High-quality AM/FM tuner with 30 station random access preset tuning.

RDS FUNCTION

Radio Data System(RDS) provides information on FM broadcasts.

ONSCREEN DISPLAY MENU SYSTEM

Easy to use **on-screen display menu system** in all video monitor output.

FRONT PANEL FEATURES (SEE PAGE iii.)

① POWER switch and STANDBY indicator

Press the button to turn the power ON, and press again to turn it OFF. If the **POWER** switch is in the ON position, the power of this unit can be turned ON/OFF by pressing the **POWER** button on the remote control unit.

When this unit is in the standby mode with the **POWER** switch set to the ON position, pressing one of the **FUNCTION SELECTOR** buttons also allows to turn the power on.

The **STANDBY** indicator lights up when this unit is the standby mode (power OFF) by the remote control unit.

② PHONES jack for stereo headphones

Conventional dynamic headphones can be plugged in here.

Notes:

- When using headphones, turn off the speakers systems A and B with **SPEAKERS** buttons. The surround mode is switched automatically to STEREO.

③ SURROUND mode selector knob

When this knob is turned, the surround mode is switched sequentially.

④ VOLUME control knob

Adjusts the over all sound level. Turning the control clockwise increases the sound level.

⑤ Function selector buttons (Audio/ Video)

These buttons are used to select the sources.

The video function selector, such as TV, DVD, VCR1, DSS/VCR2, and AUX, selects video and audio simultaneously.

Audio function sources such as CD, TAPE, CDR/MD, and TUNER may be selected in conjunction with a Video source.

This feature (Sound Injection) combines a sound from one source with a picture from another.

Choose the video source first, and then choose a different audio source to activate this function.

⑥ 6.1CH IN button

Press this button to select the output of an external multi channel decoder.

⑦ A/D (Analog/Digital) SELECTOR button

This is used to select between the analog and digital inputs.

Note:

- This button is not used for an input source that is not connected to a digital input.

⑧ S- (Source) DIRECT button

When this button is pressed, the tone control circuit is bypassed as well as Bass Management.

Notes:

- The surround mode is automatically switched to AUTO when the source direct function is turned on.
- Additionally, Speaker Configurations are fixed automatically as follow.
Front SPKR = LARGE
Center SPKR = LARGE
Surround SPKR = LARGE
Surround Center SPKR = YES
Sub woofer = YES
- S-DIRECT is turned off when the other surround mode is selected with the SURROUND mode selector knob or the surround mode buttons of the remote controller.
- S-DIRECT is not available for speaker systems B.

⑨ SLEEP (Sleep timer) button

Set the sleep timer function with this button .

⑩ DIMMER button

When this button is pressed once, the display is dimmed.

When this button is pressed twice, the display is turned off and "DISPLAY OFF" indicator lights up.

Press this button again to turn the display ON again.

⑪ MUTE button

Press this button to mute the output to the speakers. Press it again to return to the previous volume level.

⑫ CLEAR button

Press this button to cancel the station memory setting mode or preset scan tuning.

⑬ MEMORY button

Press this button to enter the tuner preset memory numbers and station names.

⑭ TUNING / PRESET UP and DOWN buttons

During reception of AM or FM, you can scan the other frequencies or select another preset station pressing these buttons.

⑮ F/P (Frequency/ Preset) button

During reception of AM or FM, you can change the function of the UP/DOWN buttons for scanning frequencies or selecting preset stations by pressing this button.

⑯ (FM) MODE button

Press this button to select the auto stereo mode or mono mode when the FM band is selected. The AUTO indicator lights in the auto stereo mode.

⑰ Infrared sensor

This window receives infrared signals from the remote control unit.

⑱ AUX input jacks

These auxiliary video/audio input jacks accept the connection of a camcorder, portable VCR, etc.

⑲ SPEAKERS buttons

Press these buttons to select speakers systems A and/or B.

REAR PANEL CONNECTIONS (SEE PAGE iii.)

All connections to the rear panel should be made with the entire system powered off.

To avoid errors, it is advisable to connect one cable at a time between the various components.

(1) FM antenna terminal (75 ohms)

Connect an external FM antenna with a coaxial cable, or a cable network FM source.

AM antenna and ground terminals

Connect the supplied AM loop antenna. Use the terminals marked "AM" and "GND".

The supplied AM loop antenna will provide good AM reception in most areas.

Position the loop antenna until you hear the best reception.

(2) PRE OUT jacks

Jacks for Front - L/R, Center, Surround-L/R and Surround center. Use these jacks for connection to an external power amplifier.

(3) SUB WOOFER output jack

Connect to the input jack(s) of the power amplifier for subwoofer channel or powered subwoofer.

(4) Analog AUDIO outputs for audio recording equipment

TAPE and CD-R/MD

Connect each output to the audio inputs (REC in) of your recording equipment.

(5) Analog AUDIO inputs

CD, TAPE, and CD-R/MD

Connect the audio outputs of your source components to the input jacks on the receiver.

(6) VIDEO (VIDEO/S-VIDEO) outputs

VCR1, and DSS/VCR2

Connect each output to the video input (REC in) of your video recording equipment.

(7) TV MONI. (VIDEO/S-VIDEO) output jacks

Connect the TV MONI jack to your TV's video input (VIDEO IN) jack. You can connect your video equipment with S-VIDEO jacks if possible, or the composite VIDEO jacks.

You must use the same type of connection from your video player into the receiver, and out of the receiver into your TV.

Both must be composite video or both must be S-Video. You cannot convert a signal from one type to the other.

(8) SPEAKER SYSTEMS terminals

SPEAKER SYSTEMS A TERMINALS

FRONT Left & Right speakers output terminals

Connect to the front left & right speakers.

CENTER speaker output terminals

Connect to the center speaker.

SURROUND Left & Right speakers output terminals

Connect to the surround (rear) left & right speakers.

SURROUND Center speaker output terminals

Connect to the surround center speaker.

SPEAKER SYSTEMS B TERMINALS

FRONT Left & Right speakers output terminals

Connect to the front left & right speakers.

Notes:

- When you use the speaker systems A and B simultaneously, the connected speakers which are impedance 12 to 16 ohms must be used.

(9) 6.1 CH INPUT jacks

Connect to the outputs of DVD Audio player, SACD Multi channel player or an external multichannel decoder.

(10) DIGITAL outputs

Optical and Coaxial

Connect to the digital input of your digital recording equipment.

(11) DIGITAL inputs

Fig.1,2 (Optical) and Fig. 3, 4, 5 (Coaxial)

Connect each input to the digital output of your source equipment.

Use the SETUP MAIN MENU to assign digital input to appropriate source. (see page 17)

Note :

- The coaxial connections are not for AC-3 RF from the LD player, If you want to decode this type of signal, an external demodulator must be used.

(12) REMOTE CONTROL IN/OUT terminals

Connect to a Marantz component equipped with remote control (RC-5) terminals.

(13) Analog AUDIO outputs for video recording equipment

VCR1, and DSS/VCR2

Connect each output to the audio inputs (REC in) of your video recording equipment.

(14) Analog AUDIO inputs for video source equipment

TV, DVD, VCR1, and DSS/VCR2

Connect each input to the audio outputs of your video source equipment.

(15) VIDEO inputs

TV, DVD, VCR1, and DSS/VCR2

Connect each input to the video outputs of your video source equipment.

(16) S-VIDEO inputs

TV, DVD, VCR1, and DSS/VCR2

Connect each input to the S-video outputs of your video source equipment.

(17) AC OUTLET

Connect the power cables of components such as a DVD or CD player to this outlet.

This provides power only when the SR6300 is turned on and is useful for components which you use every time you play your system.

Caution:

- In order to avoid potential turn-off thumps, anything plugged in here should be powered up BEFORE the SR6300 is turned on.
- The capacity of this AC outlet is 100W. Do not connect devices that consume electricity more than the capacity to this AC outlet. If total power consumption of connected devices exceeds the capacity, protection circuit shuts down the power supply.

(18) AC IN

Connect to supplied AC cable, and connect to AC power outlet. SR6300 can be powered by 230V AC only.

REMOTE CONTROLER RC7300SR

NAMES AND FUNCTIONS

1 Infrared window

Outputs and inputs an infrared control signals.

2 LCD (Liquid Crystal Display)

Used to display information about currently selected functions.

3 ▲ (open/close) button

Used to open or close the door.

4 Source POWER ON/OFF button

Used to turn specific sources (such as DVD players, etc.) ON and OFF independently from the rest of the system.

5 EQ button

Used to turn on or off HT (Home Theater)-EQ mode when the surround mode is set as AUTO, DOLBY, DTS or STEREO.

This mode compensates for the audio portion of a movie sounding "bright". When this button is pressed, "HT-EQ" indicator lights up.

6 V-OFF (video off) button

Used to turn off the video signal.

Note:

- This button is unavailable for SR6300.

7 DVD operating buttons

(when DVD mode is selected)

AUDIO button

Used to select one of the audio language.

ANGLE button

Used to change the different camera angle.

SUBTITLE button

Used to select one of the subtitle language.

8 Numeric buttons 1 to 9, 0 / Surround mode buttons

Numeric buttons

Used to enter figures in the selection of a tuner preset station and station name preset or to set select a CD track number, etc. The functions of these buttons are dependent on the function button selected.

Surround mode buttons *(when AMP mode is selected)*

Used to select the surround mode.

9 CL (clear) / S-DIRECT (source direct) button

Used to cancel for certain memory or programming operations.

(when AMP mode is selected)

Used to select the S-DIRECT (source direct) mode. In source direct mode, the tone control circuitry is bypassed.

10 INPUT button

Used to select monitor input.

11 T.MODE button

(when TUNER mode is selected)

Used to select the auto stereo mode or mono mode when the FM band is selected.

The "AUTO" indicator lights in the auto stereo mode.

12 (TV) CH ▲/▼ buttons

Used to increase or decrease the TV channel.

13 TOP MENU button

(when DVD mode is selected)

Used to call up the top menu of the DVD.

14 Tone / Deck control buttons

Tone control buttons (when AMP mode is selected)

The **TREBLE** buttons are used to adjust the tone control of high frequency sound for left and right speaker.

The **BASS** buttons are used to adjust the tone control of low frequency sound for left, right and subwoofer speaker.

Deck control buttons (when Tape mode is selected)

The **DECK A** button are used to select the deck A.

The **DECK B** button are used to select the deck B.

The ◀▶ button are used to change the direction.

15 CURSOR / OK button

Used to operate on-screen and other displays used by receivers and other components.

16 CH SEL. (channel select) button

(when AMP mode is selected)

Used to call up SETUP MAIN MENU and adjust speaker levels or 6.1 ch input level.

17 SETUP button

(when DVD mode is selected)

Used to call up the setup menu of the DVD.

18 CONTROL buttons

These buttons are used when operating the CD player, TAPE deck, etc.

The function of these buttons are dependent on the function button selected.

(when AMP mode is selected)

SPK A/B button

Speaker mode is switched in the following sequence.

A → B → A+B → off

ATT button

When the input signal is too high and the voice distorts even by throttling the SR6300 VOLUME control, turn on this function. "ATT" is indicated when this function is activated.

The input level is reduced. Attenuator is invalid for use with the output signal of "REC OUT".

Note:

- This function is unavailable during the digital input is selected.

MULTI button

This button is unavailable for SR6300.

19 Input selector buttons/ FUNCTION SELECTOR buttons (AUDIO/VIDEO INPUT)

Press one of these buttons once or twice to select a particular source component.

For example, to set the receiver to the DVD input, press the **DVD** button twice within 2 seconds.

Note:

- The **AUX2** button is unavailable for SR6300.

20 EXIT button

(when AMP mode is selected)

Used to exit SETUP MAIN MENU or On Screen Display.

21 TEST button

(when AMP mode is selected)
Used to enter the test tone menu.

22 MENU/OSD button

(when AMP mode is selected)
When this button is pressed, the current setting are displayed on the TV monitor.

23 VOLUME ▲ / ▼ buttons

Used to adjust the volume on receivers and other components equipped with volume control.

24 P.SCAN (preset scan) button

(when TUNER mode is selected)
Used to start preset scan when SR6300 is selected TUNER mode.

25 MUTE button

Muting button of the SR6300. Press this button decrease the sound temporarily. Press this button again to return to the previous sound. When this button is pressed, "MUTE" indicator lights up.

26 MEMO button

Memory enable button for various preset functions.

27 NIGHT button

(when AMP mode is selected)
Pressing this button prevents the Dolby Digital signal from playback at a loud voice. This function reduces the voice by 1/3 to 1/4 at maximum. Thus, it eliminates the occurrence of an abruptly loud voice at night. However, the function is valid only for the case when the Dolby Digital signal is entered into OPTICAL or COAXIAL and data to compress the voice exists in the signal to be played back. When this button is pressed, "NIGHT" indicator lights up.

28 PTY button

(when TUNER mode is selected)
Used to display the programme type information of the current station. The RDS system categorizes programmes according to their genre into different programme type (PTY) groups.

29 F.DIR/SEAR button

(when TUNER mode is selected)
Used to select the mode of frequency direct input.

30 DISP./RDS button

(when TUNER mode is selected)
Selects display mode function in RDS (Radio Data System) by this button.

(when AMP mode is selected)
When this button is pressed once, the display is dimmed.
When this button is pressed twice, the display is turned off and "DISPLAY OFF" indicator lights up.
Press this button again to turn the display ON again.

31 A/D button

This is used to switch between the analog and digital inputs.

32 SLEEP (sleep timer) button

This button is used for setting the sleep timer. It can be operated the same way as the button in unit.

33 7.1/6.1CH IN button

Press this button to select the output of an external multi channel decoder.

34 POWER buttons

(when AMP mode is selected)
Press to switch the power of the SR6300 ON or OFF.

LCD (Liquid Crystal Display)

Information about currently selected functions and modes is displayed on the LCD.

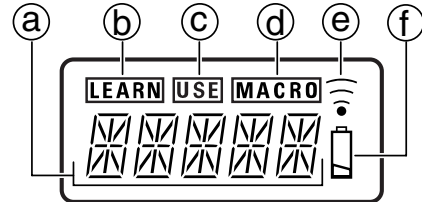
**a Function Name indicator**

Displays the name of the currently selected function (DVD, TV, etc.) using up to 5 characters.

b LEARN indicator

Indicates when the remote controller is in the LEARN mode.

c USE indicator

For normal operation the USE indicator is displayed.

d MACRO indicator

Indicates when the remote controller is in the MACRO mode.

e Transmission indicator

Indicates when the remote controller is transmitting a signal.

f Low battery indicator

When this indicator appears, the batteries should be replace.

REMOTE CONTROL RANGE

The distance between the transmitter of the remote control unit and the IR SENSOR of the SR6300 should be less than about 5 meters. If the transmitter is pointed to a direction other than the IR SENSOR or if there is an obstacle between them, remote control may not be possible.

Remote-controllable range

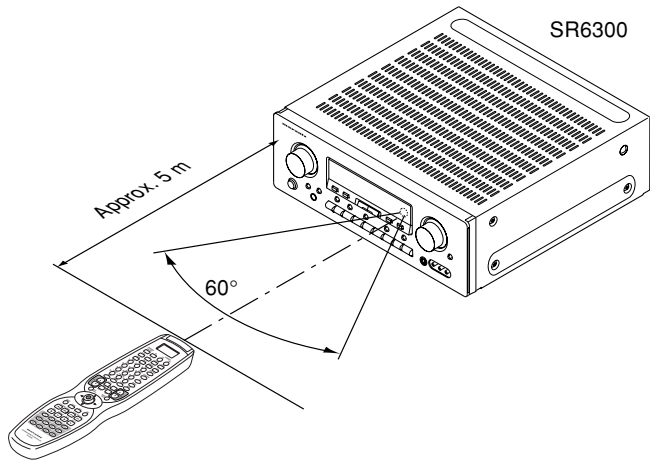

Remote control unit (RC7300SR)

LOADING BATTERIES

The life of the batteries used with the remote control unit is about 4 months with normal use. Also be sure to replace batteries earlier when you notice that they are getting weak.

1. Remove the back cover.

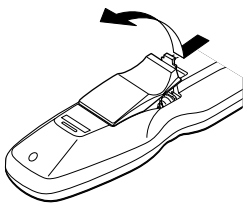

2. Insert the new batteries (AA type) with correct (+) and (-) polarity.

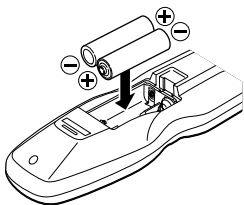

3. Close until it clicks.

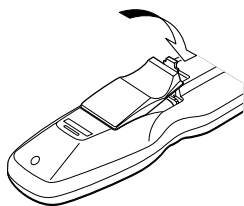

Note:

- The supplied batteries are shipped to confirm the initial operation. Therefore, the supplied batteries will be consumed quickly.

GENERAL INFORMATION OF RC7300SR TO SR6300

To control the SR6300 by your RC7300SR, you have to select the device AMP by function selector button. Please refer as below for the details in AMP mode.

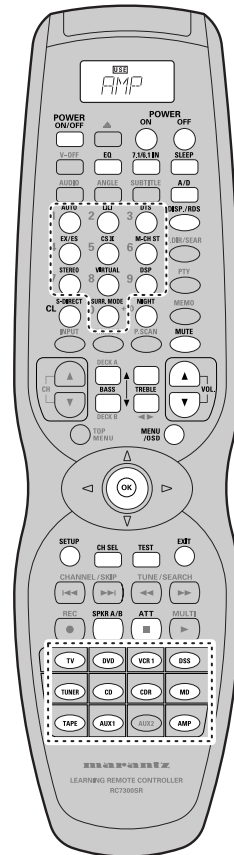

POWER ON/OFF	Turns the SR6300 on and off
POWER ON	Turns the SR6300 on
POWER OFF	Turns the SR6300 off
EQ	Turns on or off HT-EQ mode
7.1/6.1 IN	Selects the 6.1CH IN
SLEEP	Sets the sleep timer function
A/D	Switches between the analog and digital inputs
DISP./RDS	Changes the brightness of the front display
Surround mode (0-9)	Selects the surround mode
S-DIRECT	Selects the Source Direct mode
NIGHT(+10)	Turns on or off NIGHT mode
MUTE	Decreases the sound temporarily
BASS ▲▼	Adjusts the tone control of low frequency sound
TREBLE ▲▼	Adjusts the tone control of high frequency sound
VOL ▲▼	Adjusts the over all sound level
MENU/OSD	Displays the current setting on the monitor
Cursor	Moves the cursor for setting in "On screen display" mode
OK	• Enter the "On screen display" mode • Confirms the setting in "On screen display" mode
SETUP	Same as OK button
CH SEL	Calls up SETUP MAIN MENU and adjusts speaker levels or 6.1ch input level
TEST	Enters the test tone menu
EXIT	Exits from SETUP MAIN MENU
SPKR A/B	Selects the speaker system
ATT	Reduces the input level
Function selector	Selects a particular source component

CONNECTIONS

SPEAKER PLACEMENT

The ideal surround speaker system for this unit is 7-speaker systems, using front left and right speakers, a center speaker, surround left and right speakers, a surround center and a subwoofer.

For best results we recommend that all front speakers be of the same type, with identical or similar driver units. This will deliver smooth pans across the front sound stage as the action moves from side to side.

Your center channel speaker is very important as over 80 % of the dialog from a typical motion picture emanates from the center channel. It should possess similar sonic characteristics to the main speakers. Surround channel speakers need not be identical to the front channel speakers, but they should be of high quality.

The surround center speaker is useful for playback of Dolby Digital Surround EX or DTS-ES. One of the benefits of both Dolby Digital (AC-3) and DTS is that surround channels are discrete full range, while they were frequency limited in earlier "Pro Logic" type systems. Bass effects are an important part of home theater. For optimal enjoyment a subwoofer should be used as it is optimized for low frequency reproduction. If you have full range front speakers, however, they may be used in place of a subwoofer with proper setting of the switches in the menu system.

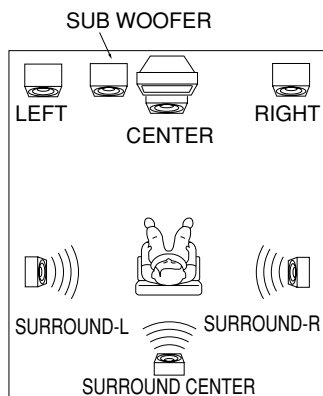

Front left and right speakers

We recommend to set the front L and R speakers with 45-60 degrees from the listening position.

Center speaker

Align the front line of the center speaker with the front L/R speakers. Or place the center speaker a little backward from the line.

Surround left and right speakers

Place the speakers just beside of the listening position or a little forward. Do not place the speakers backward of the listening position.

Surround center speaker

Place the speaker just behind of the listening position.

Subwoofer

We recommend to use a sub-woofer to have maximum bass effect. Sub-woofer bears only low frequency range so you can place it anywhere in the room.

HEIGHT OF THE SPEAKER UNITS

Front left and right speakers, and a center speaker

Align the tweeters and mid-range drivers on the three front speakers on the same height as well as possible.

Surround left and right speakers, and surround center speaker

Place the surround left, right and surround center speakers higher to your ears (70cm – 1m). Also place the speakers on the same height.

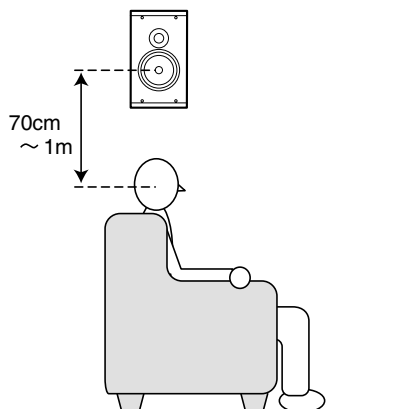

Note;

- Use magnetically-shielded speakers for front left, right and the center speakers when the speakers are installed near the TV and the TV is a monitor type.

CONNECTING SPEAKERS

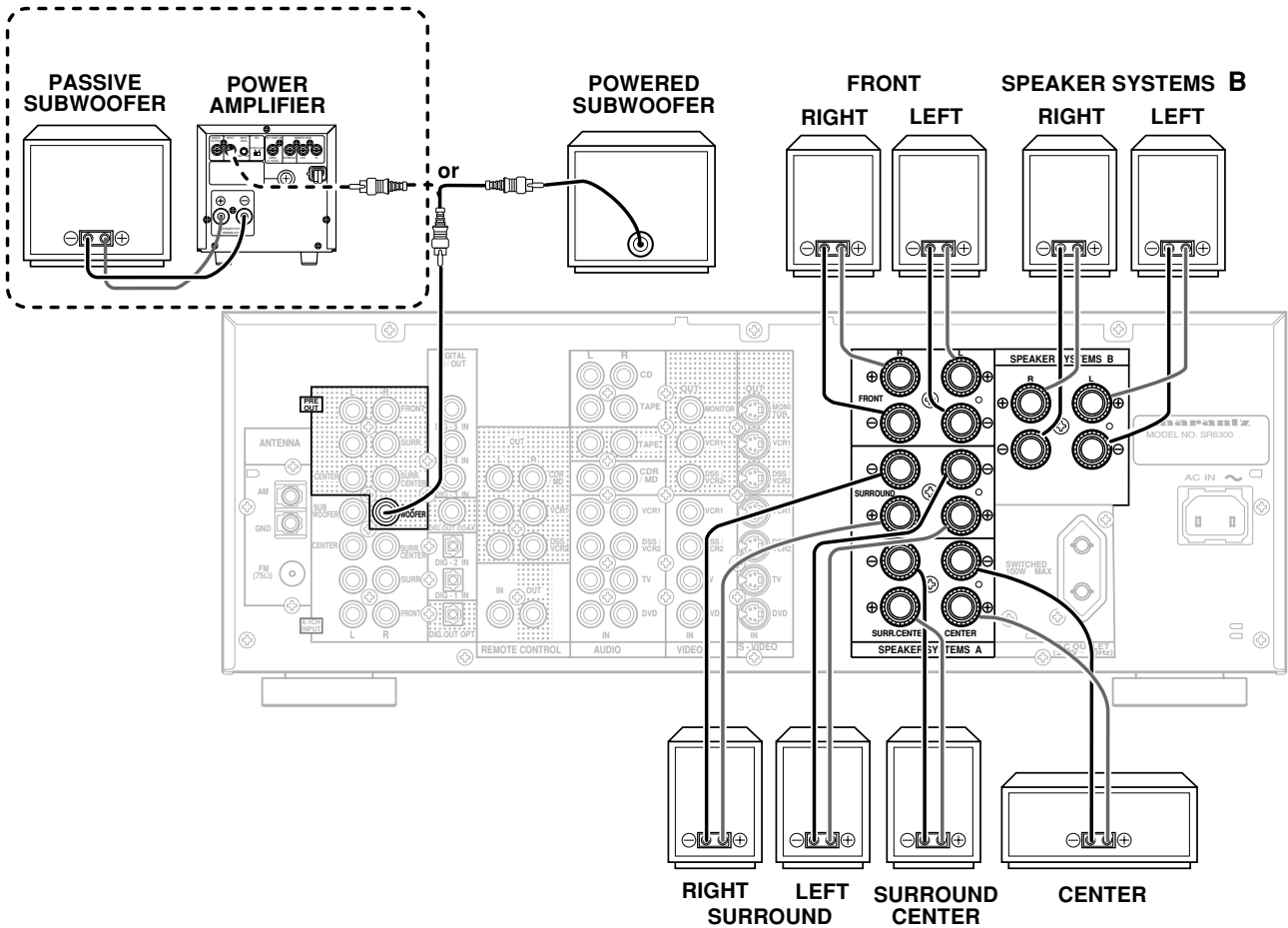

CONNECTING SPEAKER WIRE

1. Strip away approx. 10 mm of wire insulation.
2. Twist the bared wire ends tight to prevent short circuits.
3. Loosen the knob by turning counterclockwise.
4. Insert the bare part of the wire into the hole in the side of each terminal.
5. Tighten the knob by turning clockwise to secure the wire.

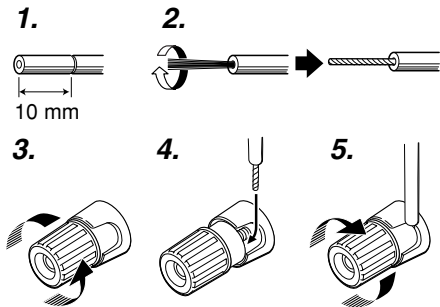

CAUTION

- Be sure to use speakers with the specified impedance shown on the rear panel of this unit.
- To prevent damage to circuitry, do not let the bare speaker wires touch each other and do not let them touch any metal part of this unit.
- Do not touch the speaker terminals when the power is on. It may cause electric shocks.
- Do not connect more than one speaker cable to one speaker terminal. Doing so may damage this unit.

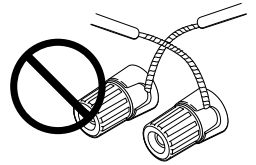

NOTE

- Be sure to connect the positive and negative cables for the speaker properly. If they are miss-connected, the signal phase will be reversed and the signal quality will be corrupted.

CONNECTING A SUBWOOFER

Use the PRE OUT SUBWOOFER jack to connect a powered subwoofer (power amplifier built in). If your subwoofer is passive type (power amplifier is not built in), connect a monaural power amplifier to the PRE OUT SUBWOOFER jack and connect the subwoofer to the amplifier.

CONNECTING AUDIO COMPONENTS

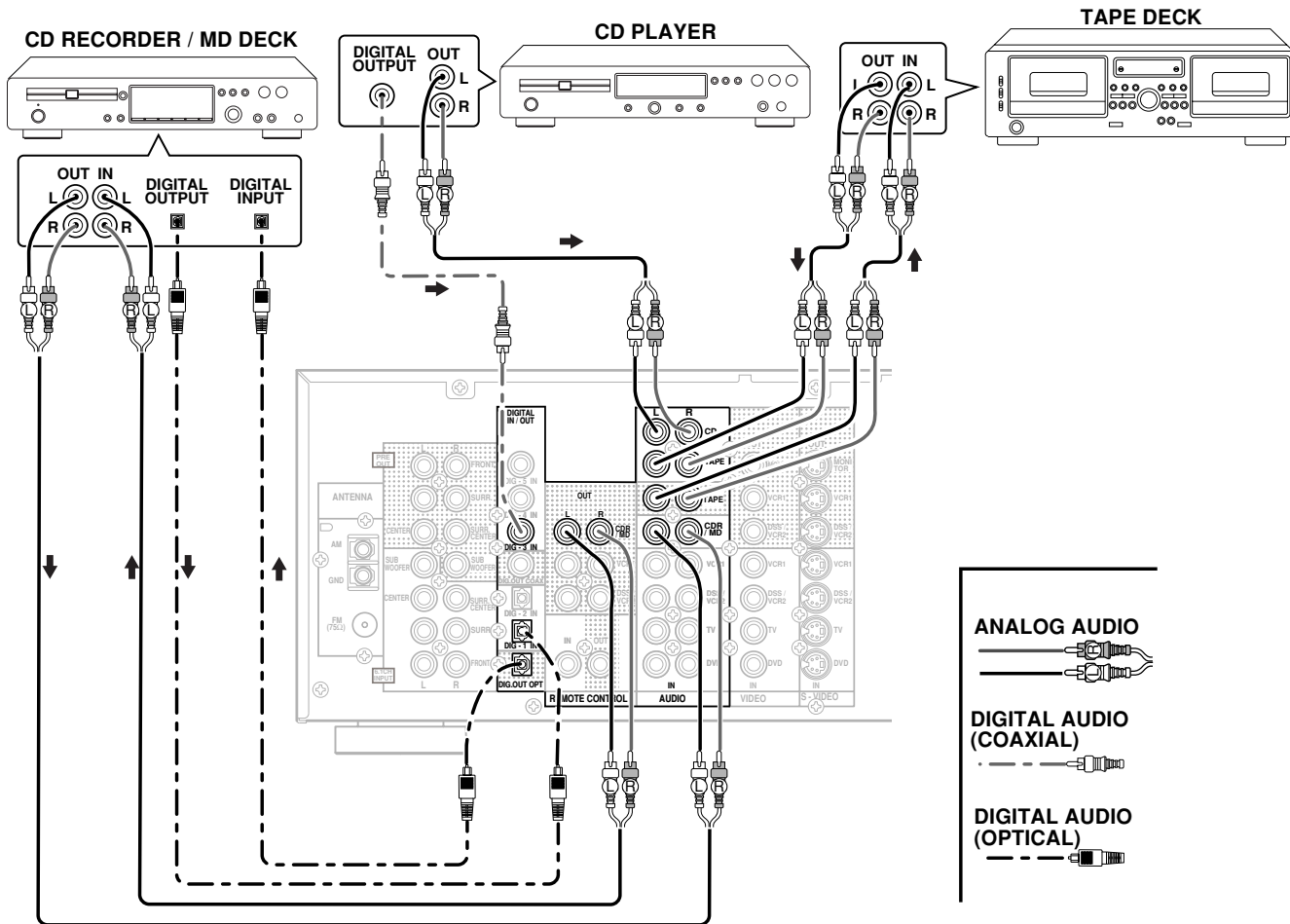

The output audio signal from the TAPE OUT jack and the CD-R/MD OUT jack is the sound source currently selected.

CAUTION

- Do not connect this unit and other components to mains power until all connections between components have been completed.

NOTES

- Insert all plugs and connectors securely. Incomplete connections may make noise.
- Be sure to connect the left and right channels properly. Red connectors are for the R(right) channel, and white connectors are for the L(left) channel.
- Be sure to connect input and output properly.
- Refer to the instructions for each component that is connected with this unit.
- Do not bind audio/video connection cables with power cords and speaker cables will result in generating hum or other noise.

CONNECTING DIGITAL AUDIO COMPONENTS

- There are four digital inputs, two coaxial jacks and two optical jacks, on the rear panel. You can use these jacks to input PCM, Dolby Digital and DTS bitstream signals from a CD, DVD, or other digital source components.
- There are one digital output with coaxial jack and one with optical jack on the rear panel. These jacks can be connected to CD recorder, MD deck.
- Setup the digital audio format of DVD player, or other digital source component. Refer to the instructions for each component to be connected to digital input jacks.
- Use fiber optical cables(optical) for DIG-1,2 input jacks. Use 75 ohms coaxial cables(for digital audio or video) for DIG-3,4, 5 input jacks.
- You can designate the input for each digital input/output jacks according to your component. See page 17.

NOTES

- There is no Dolby Digital RF input jack. Please use an external RF demodulator Dolby Digital decoder when connecting the Dolby Digital RF output jack of the video disc player to the digital input jack.
- The digital signal jacks on this unit conform to the EIA standard. If you use a cable that does not conform to this standard, this unit may not function properly.
- Each type of audio jack works independently. Signals input through the digital and analog jacks are output through the corresponding digital and analog jacks, respectively.

CONNECTING VIDEO COMPONENTS

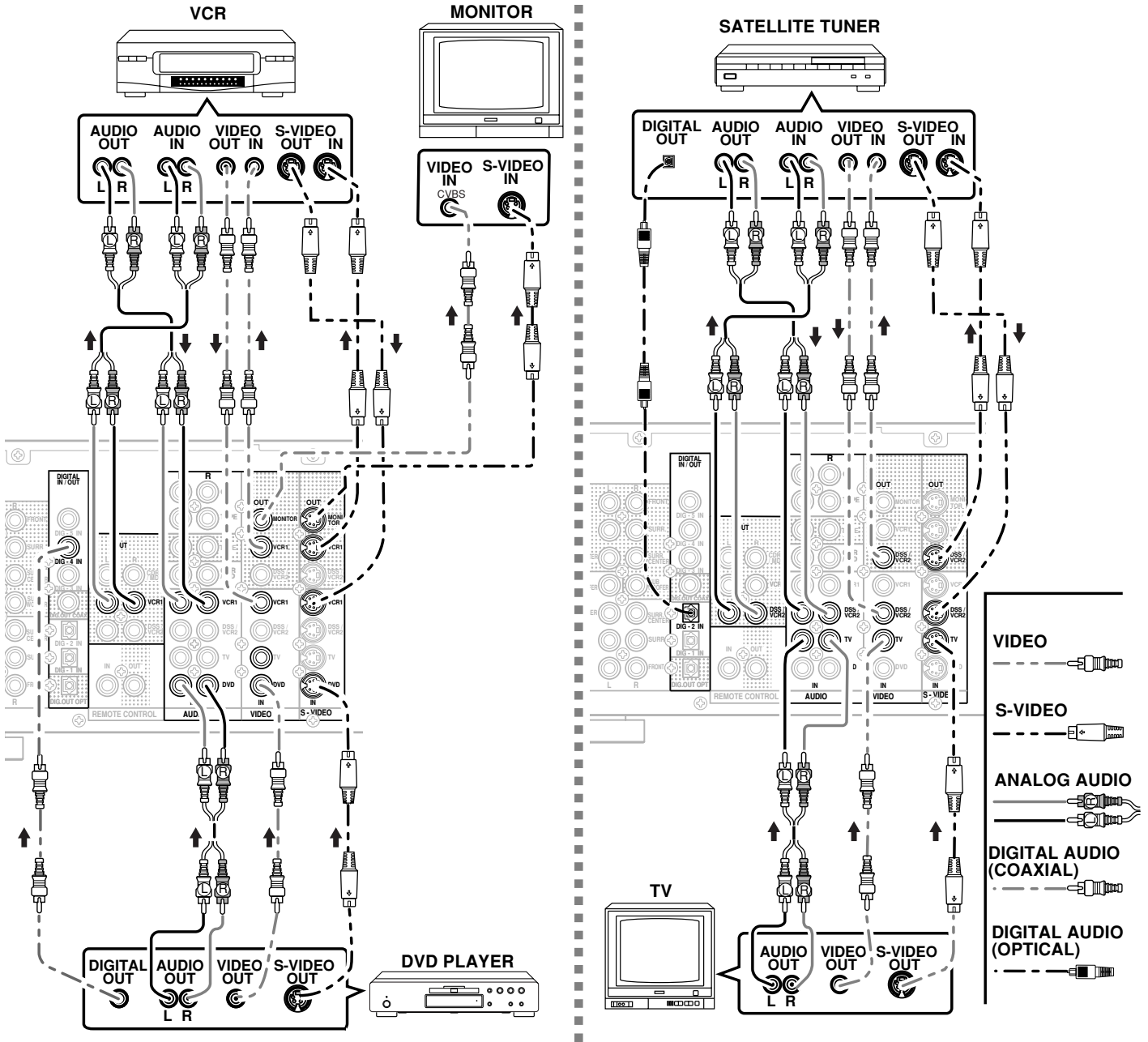

VIDEO, S-VIDEO JACKS

There are two types of video jacks on the rear panel.

VIDEO jack

The video signal for the VIDEO jacks is the conventional composite video signal.

S-VIDEO jack

The video signal is separated into luminance(Y) and color(C) signals for the S-VIDEO jack. The S-VIDEO signals enables high-quality color reproduction. If your video component has an S-VIDEO output, we recommend to use it. Connect the S-VIDEO output jack on your video component to the S-VIDEO input jack on this unit.

NOTES

- Be sure to connect the left and right audio channels properly. Red connectors are for the R(right) channel, and white connectors are the for L(left) channel.
- Be sure to connect input and output of video signal properly.

- Each type of video jack works independently. Signals input to the VIDEO(composite) and S-VIDEO jacks are output to the corresponding VIDEO(composite) and S-VIDEO jacks, respectively.
- This unit has the "TV-AUTO ON/OFF" function to turn ON or OFF automatically the power by the incoming video signal from VIDEO jacks.
- You may need to setup the digital audio output format of your DVD player, or other digital source component. Refer to the instructions of the each component connected to the digital input jacks.
- There is no Dolby Digital RF input jack. Please use an external RF demodulator with Dolby Digital decoder to connect a video disc player with the Dolby Digital RF output jack to the digital input jack on this unit.

ADVANCED CONNECTING

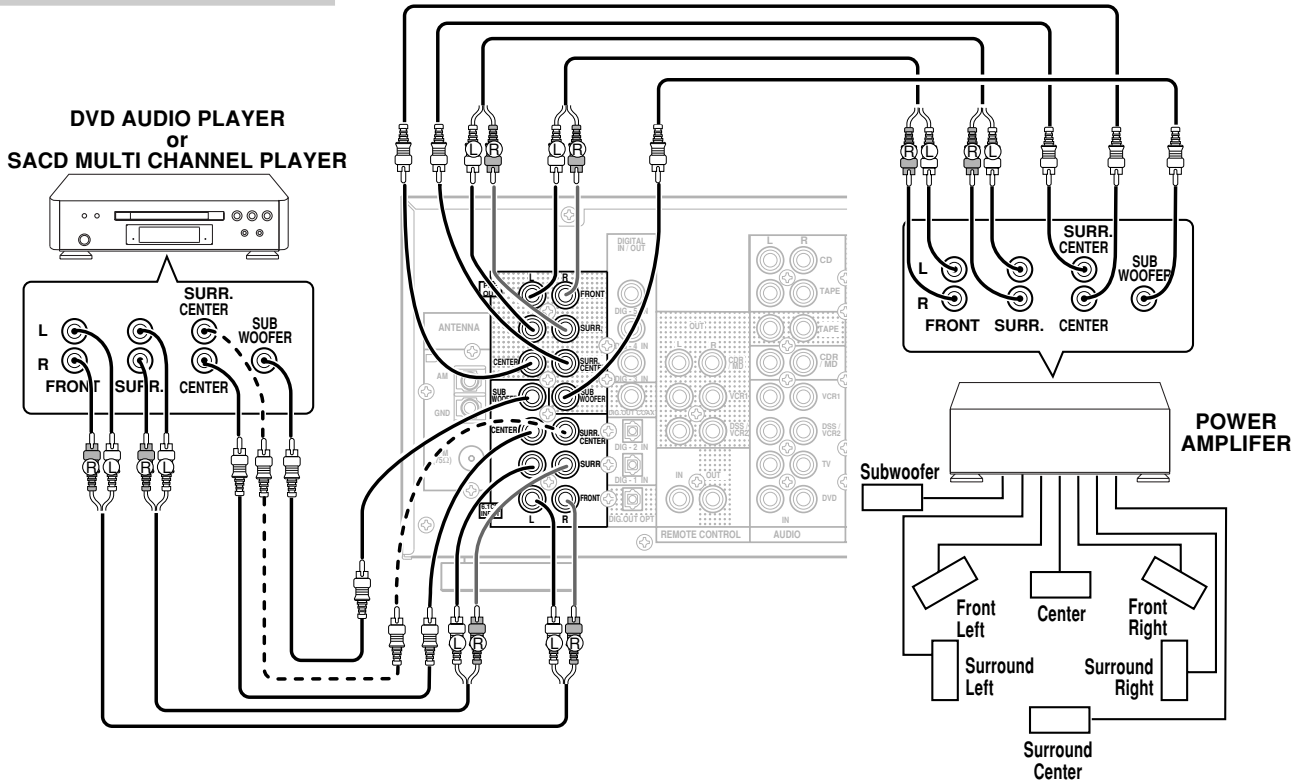

CONNECTING MULTI CHANNEL AUDIO SOURCE

The 6.1CH INPUT jacks are for multi channel audio source such as SACD multi channel player, DVD audio player or external decoder. If you use these jacks, switch on 6.1CH INPUT and setup 6.1CH INPUT level by using SETUP MAIN MENU. See page 20.

CONNECTING EXTERNAL POWER AMPLIFIER

The PREOUT jacks are for connecting external power amplifiers, you can have better sound quality. Be sure to connect each speaker to the corresponding external power amplifier.

CONNECTING REMOTE CONTROL JACKS

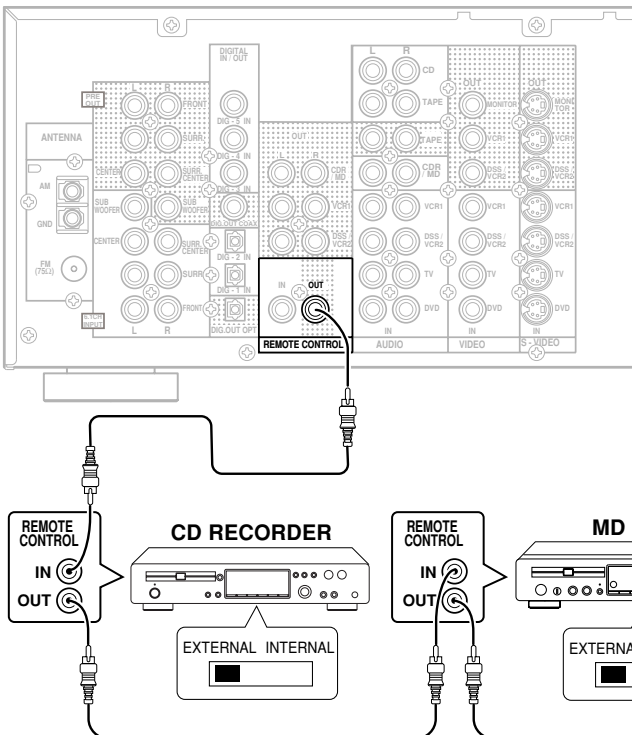

You can control other Marantz products through this unit with the remote controller by connecting REMOTE CONTROL terminals on each unit.

The signal transmitted from the remote controller is received by the remote sensor on this unit then the signal is sent to the connected device through this terminal. Therefore you need to aim the remote signal only to the unit. Also, if a Marantz power amplifier (some models excluded) is connected with this terminal, the power amplifier's power switch is synchronized with this unit's power switch.

Set the REMOTE CONTROL SWITCH on the units other than this unit to EXT.(EXTERNAL) for this feature.

CONNECTING THE ANTENNA TERMINALS

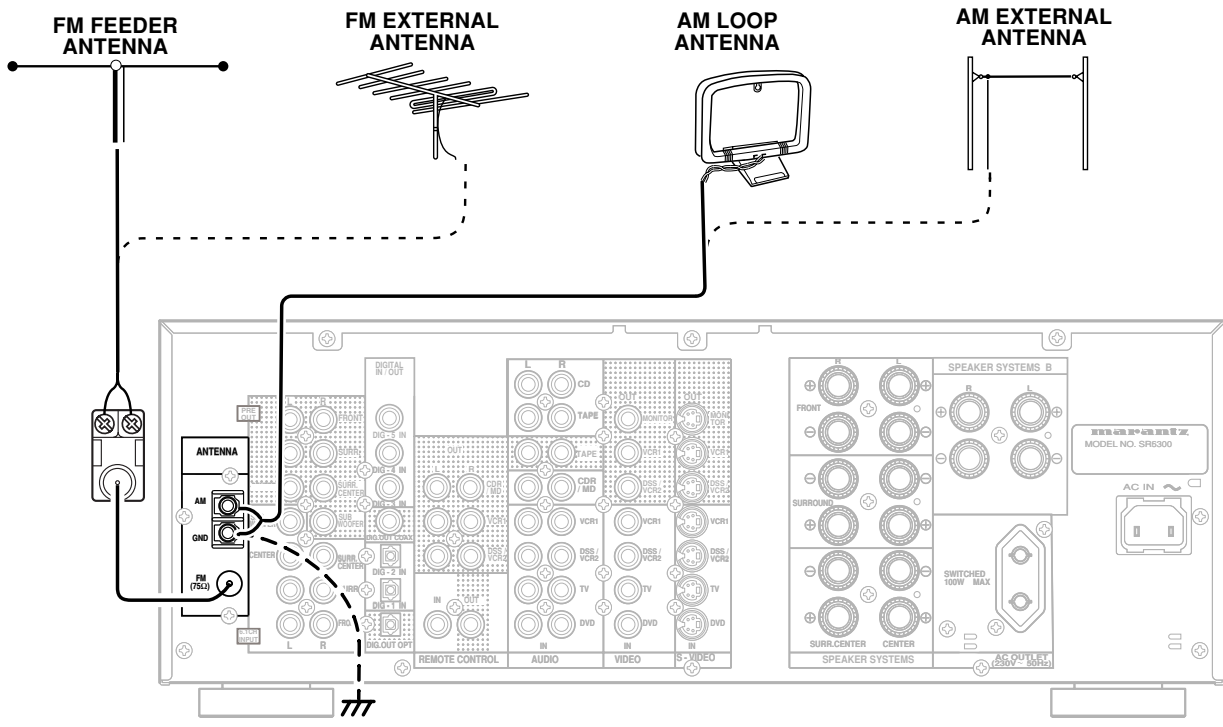

ASSEMBLING THE AM LOOP ANTENNA

1. Release the vinyl tie and take out the connection line.
2. Bend in the reverse direction.
3. Inserting into the hole to attach the loop antenna to the antenna stand.
4. With the antenna on top any stable surface.

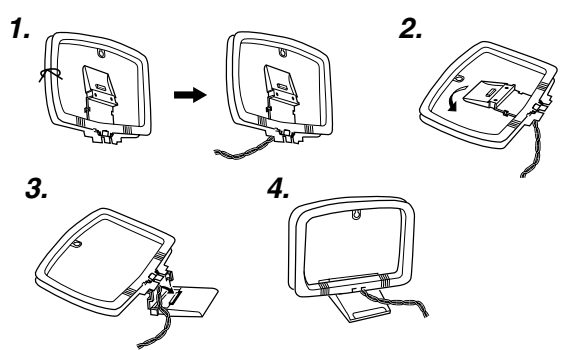

CONNECTING THE SUPPLIED ANTENNAS

Connecting the supplied FM feeder antenna

The supplied FM feeder antenna is for indoor use only. During use, extend the antenna and move it in various directions until the clearest signal is received. Fix it with push pins or similar implements in the position that will cause the least amount of distortion. If you experience poor reception quality, an outdoor antenna may improve the quality.

Connecting the supplied AM loop antenna

The supplied AM loop antenna is for indoor use only. Set it in the direction and position where you receive the clearest sound. Put it as far away as possible from the unit, televisions, speaker cables, and power cords. If you experience poor reception quality, an outdoor antenna may improve the quality.

1. Loosen the AM antenna terminal screw counterclockwise.
2. Insert the bared wire into the antenna terminal.
3. Tighten the screw by turning clockwise to secure the wire

CONNECTING THE ANTENNA CABLE TO THE 75/300 Ω ANTENNA ADAPTER

Connecting the 300 Ω ribbon wire

Loosen the screws and wrap the wire around these screws. Then tighten the screws with a screwdriver.

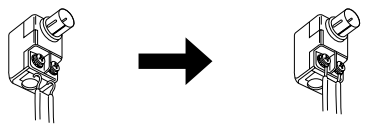

CONNECTING AN FM OUTDOOR ANTENNA

NOTES

- Keep the antenna away from noise sources (neon signs, busy roads, etc.).
- Do not put the antenna close to power lines. Keep it well away from power lines, transformers, etc.
- To avoid the risk of lightning and electrical shock, grounding is necessary.

CONNECTING AN AM OUTDOOR ANTENNA

An outdoor antenna will be more effective if it is stretched horizontally above a window or outside.

NOTES

- Do not remove the AM loop antenna.
- To avoid the risk of lightning and electrical shock, grounding is necessary.

SETUP

After all components are connected, initial setup must be performed.

ON SCREEN DISPLAY MENU SYSTEM

The SR6300 incorporates an on-screen menu system, which makes various operations possible by using the cursor (▲, ▼, ◀, ▶) and OK buttons on the remote control unit.

Notes:

- To view the on-screen displays, make certain you have made a connection from the Monitor Out jack (VIDEO or S-VIDEO) on the rear panel to the composite, S-Video input of your TV or projector. (see page 13)
- In order to view the SR6300's displays, the correct video source must be selected on the video display.

1. Select the **AMP** mode in remote controller.
2. Press **OK** button on the remote controller to display the "SETUP MAIN MENU" of the OSD menu system. There are 7 items in the SETUP MAIN MENU.
 - You can press the **SETUP** button to call up SETUP MAIN MENU.
3. Select a desired sub-menu with ▲ or ▼ cursor button, and press the **OK** button to entry.

The display will change to selected sub-menu.

You can lock the condition of setup to each sub-menu with ◀ or ▶ cursor buttons.

Notes: If you desire to adjust any sub-menu, you need to set **UNLOCK**.
4. If you desire to exit from this menu system, press **EXIT** button or move the cursor to **EXIT** and press the **OK** button.

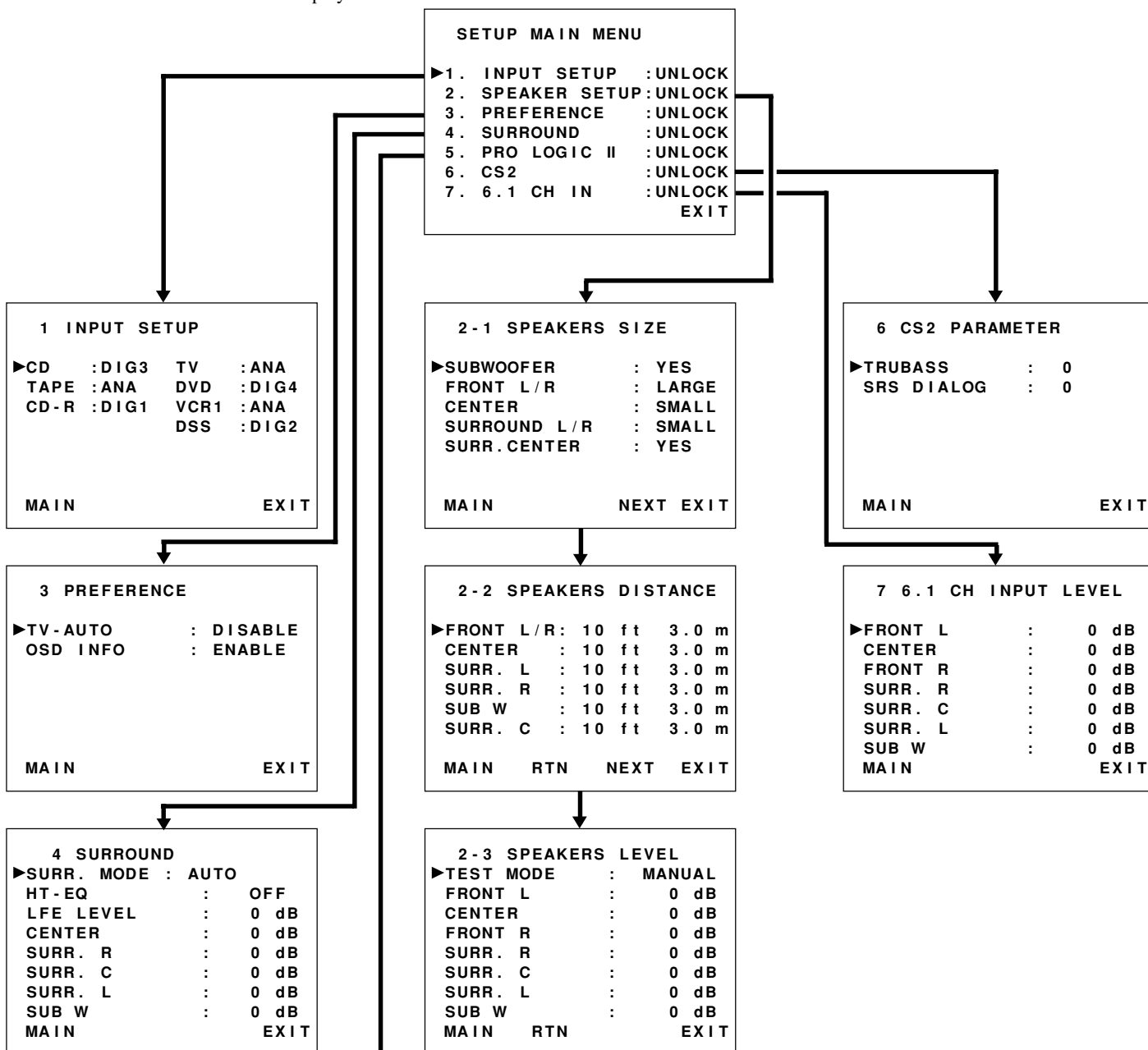

Note:

- If this setup does not meet the video input signal, character of OSD can not synchronize. So You can select these format function by function. Press **MENU/OSD** button [22] on the remote controller for 3 seconds or more. "PAL" or "NTSC" will be shown on the display of SR6300, press **MENU/OSD** button [22] again to change the TV format. The indication on FL display will change "PAL" → "NTSC" → "PAL"→.

INPUT SETUP (ASSIGNABLE DIGITAL INPUT)

Five digital inputs can be assigned as the desired source. Use this menu to select the digital input jack to be assigned to the input source.

1. Select "INPUT SETUP" in SETUP MAIN MENU with ▲ or ▼ cursor button, and press the OK button.

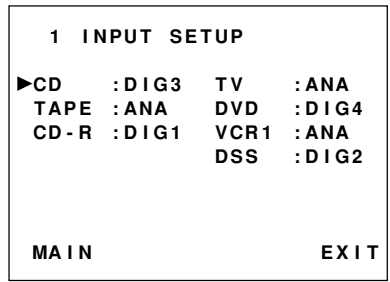

2. To select the input source, press ▲ or ▼ cursor button.
3. To select the digital input jack, press ◀ or ▶ cursor buttons. Select "Dig x" for input sources, for fixed the digital input jack. Select "ANA" for input sources for which no digital input jacks are used.
4. If you finish the setup in this sub-menu, move cursor to MAIN with ▲ or ▼ cursor buttons and press OK button.

- Notes:**
- The TUNER and AUX are fixed to the analog input, and cannot be selected for any digital input.
 - When a DTS-LD or DTS-CD is playing, this setup is not available. This is to avoid noise being generated from the analog input.

SPEAKER SETUP

After you have installed the SR6300, connected all the components, and determined the speaker layout, it is now time to perform the settings in the Speaker Setup menu for the optimum sound acoustics for your environment and speaker layout. Before you perform the following settings, it is important that you first determine the following characteristics:

SPEAKER SIZE

When setting the speaker size in the SPEAKER SIZE sub-menu, use the guidelines given below.

- LARGE:** The complete frequency range for the channel you are setting will be output from the speaker.
- SMALL:** Frequencies of the channel you are setting lower than 100 Hz will be output from the subwoofer.
- If the Subwoofer is set to "NONE" and the front speakers are set to "LARGE," then the sound may be output from both the left and right speakers.

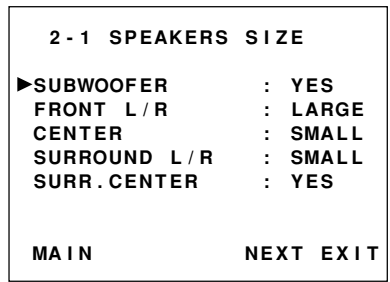

1. Select "SPEAKER SETUP" in MAIN SETUP MENU with ▲ or ▼ cursor button, and press the OK button.
2. To select the each speaker, press ▲ or ▼ cursor button.

3. To select the setting of size to each speaker, press ◀ or ▶ cursor buttons.
4. If you finish these setup, move cursor to "NEXT" with ▲ or ▼ cursor button and then press OK button to go to next page.

SUBWOOFER:

- YES:** Select when a subwoofer is connected.
NONE: Select when a subwoofer is not connected.

FRONT L/R

- LARGE:** Select if the front speakers are large sized.
SMALL: Select if the front speakers are small sized.
- If "NONE" is selected for the Subwoofer setting, then this setting is fixed to "LARGE."
 - If "SMALL" is selected for the FORNT L/R, then the center and surround L/R can not select "LARGE."

CENTER

- NONE:** Select if no center speaker is connected.
LARGE: Select if the center speaker is large sized.
SMALL: Select if the center speaker is small sized.

SURROUND L/R

- NONE:** Select if no surround left and right speakers are connected.
LARGE: Select if the surround left and right speakers are large sized.
SMALL: Select if the surround left and right speakers are small sized.

SURR. CENTER

- YES:** Select when a surround center is connected.
NONE: Select when a surround center is not connected.
- If "NONE" is selected for the Surround L/R setting, then this setting is not available.

SPEAKER DISTANCE (TIME ALIGNMENT)

Use this parameter to specify the distance of each speaker's position from the listening position. The delay time is automatically calculated according to these distances.

Begin by determining the ideal or most commonly used seating position in the room.

This is important for the timing of the acoustics to create the proper sound space that the SR6300 and today's sound systems are able to produce.

Note that the speakers that you selected "NONE" for in the Speaker Config sub-menu will not appear here.

(There are several useful books and special DVD and LD's available to guide you through proper home theater configuration. If you are unsure, have your Marantz dealer perform the installation for you.

They are trained professionals familiar with even the most sophisticated custom installations.)

2 - 2 SPEAKERS DISTANCE			
▶FRONT L / R :	10 ft	3.0 m	
CENTER :	10 ft	3.0 m	
SURR. L :	10 ft	3.0 m	
SURR. R :	10 ft	3.0 m	
SUB W :	10 ft	3.0 m	
SURR. C :	10 ft	3.0 m	
MAIN	RTN	NEXT	EXIT

- To select the each speaker , press ▲ or ▼ cursor button.
- To set the distance for each speaker , press the ◀ or ▶ cursor buttons.
- If you finish these setup, move cursor to "NEXT" with ▲ or ▼ cursor button and then press OK button to go to next page.

FRONT L/R : Set the distance from the front left/right speaker to your normal listening position between 1 and 30 feet in 1.0 foot interval (0.3 to 9 meters in 0.3-meter intervals).

CENTER : Set the distance from the center speaker to your normal listening position between 1 and 30 feet in 1.0 foot interval (0.3 to 9 meters in 0.3-meter intervals).

SURR. L : Set the distance from the surround left speaker to your normal listening position between 1 and 30 feet in 1.0 foot interval (0.3 to 9 meters in 0.3-meter intervals).

SURR. R : Set the distance from the surround right speaker to your normal listening position between 1 and 30 feet in 1.0 foot interval (0.3 to 9 meters in 0.3-meter intervals).

SUB W : Set the distance from the subwoofer to your normal listening position between 1 and 30 feet in 1.0-foot intervals (0.3 to 9 meters in 0.3-meter intervals).

SURR. C : Set the distance from a surround center speaker to your normal listening position between 1 and 30 feet in 1.0-foot intervals (0.3 to 9 meters in 0.3-meter intervals).

Notes

- Speakers that you selected "NONE" for in the Speaker Size menu will not appear.

SPEAKERS LEVEL

Here you will set the volume for each speaker so that they are all heard by the listener at the same level.

Note:

- The speaker level settings is not available in 6.1channel input mode and S-Direct mode.

2 - 3 SPEAKERS LEVEL		
▶TEST MODE :	MANUAL	
FRONT L :	0 dB	
CENTER :	0 dB	
FRONT R :	0 dB	
SURR. R :	0 dB	
SURR. C :	0 dB	
SURR. L :	0 dB	
SUB W :	0 dB	
MAIN	RTN	EXIT

TEST MODE : Selects "MANUAL" or "AUTO" for generating mode of test tone ◀ or ▶ cursor button.

If you select "AUTO", the test tone will be cycled through in a circular pattern which is Left → Center → Right → Surround Right → Surround Center → Surround Left → Subwoofer → Left →... increments of 2 seconds for each channel.

Using the ◀ and ▶ cursor buttons, adjust the volume level of the noise from the speaker so that it is the same level for all speaker.

If you select "MANUAL", adjust the output level of each speaker as follows.

- When you move cursor to FRONT L by pressing ▼ cursor button, the SR6300 will emit a pink noise from the front left speaker. At this time, the master volume automatically increases to the reference level (0 dB). Remember the level of this noise and then press the ▼ cursor button. (Note that this can be adjusted to any level between -10 and +10 dB in 1 dB intervals.) The SR6300 will now emit the pink noise from the center speaker.
- Using the ◀ and ▶ cursor buttons, adjust the volume level of the noise from the center speaker so that it is the same level as the front left speaker.
- Press the ▼ cursor button again. The SR6300 will now emit the pink noise from the front right speaker.
- Repeat steps 2 and 3 above for the front right and other speakers until all speakers are adjusted to the same volume level.

If you finish these setup, press OK button, the cursor will move to "MAIN" and then press OK button to go to SETUP MAIN MENU.

Notes:

- Speakers that you selected "NONE" for in the Speaker Size menu will not appear.
- The setup level for each channel is memorized for reproduction in all surround mode.
- To adjust the speaker levels for 6.1-channel input sources, you will need to use the 6.1CH-INPUT sub menu. (See page 20).

PREFERENCE

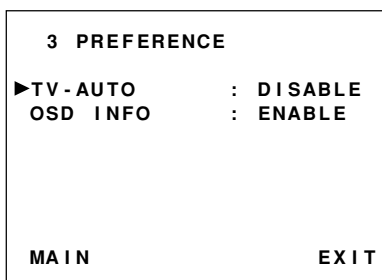

1. Select "PREFERENCE" in SETUP MAIN MENU with ▲ or ▼ cursor button, and press the OK button.
2. To select a desired content, press ▲ or ▼ cursor button.

TV AUTO: Select the TV AUTO ON/OFF function to enable or disable with ◀ or ▶ cursor button.
(refer to page 23)

OSD INFO: Select the OSD information function to enable or disable with ◀ or ▶ cursor button.

If you select "ENABLE", SR6300 will display the status of the feature (Volume up/down, input select, etc..) on the TV monitor. But if you do not desire this information, select "DISABLE".

If you finish the setup in this item, move cursor to "MAIN" with ▲ or ▼ cursor buttons and press OK button.

SUB W : Adjust the volume level of the subwoofer speaker between -15 dB and +10 dB in 1 level interval with ◀ or ▶ cursor button.

If you finish the setup in this item, move cursor to "MAIN" with ▲ or ▼ cursor buttons and press OK button.

Note:

- CENTER, SURR.R, SURR. C, SURR. L, and SUB W volume level are synchronized with SETUP MAIN MENU 2-3 Speaker Level.

PLII (PRO LOGIC II) MS PARAMETER

Pro Logic II-Music mode creates a rich and enveloping surround ambience from stereo sources such as CDs.

In this mode, SR6300 includes three controls to fine-tune the soundfield as follow.

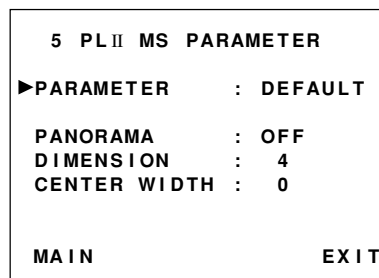

Select "PRO LOGIC II" in SETUP MAIN MENU with ▲ or ▼ cursor button, and press the OK button.

PARAMETER: Select "DEFAULT" or "CUSTOM" with ◀ or ▶ cursor button

If you select "CUSTOM", you can adjust three parameters as follow

PANORAMA: Select the Panorama mode On or Off with ◀ or ▶ cursor button.

Panorama wraps the sound of the front left and right speakers around you for an exciting perspective.

DIMENSION: Set the Dimension level between 0 and 6 level in 1 level interval with ◀ or ▶ cursor button.

Adjust the soundfield either towards the front or towards the rear.

This can be useful to help achieve a more suitable balance from all the speakers with certain recordings.

CENTER WIDTH: Set the Center width level between 0 and 7 level in 1 level interval with ◀ or ▶ cursor button.

Center Width allows you to gradually spread the center channel sound into the front left and right speakers.

At its widest setting, all the sound from the center is mixed into the left and right.

This control may help achieve a more spacious sound or a better blend of the front image.

If "NONE" was selected for the Center speaker setting in the Speaker size, then this setting will not appear.

If you finish the setup in this menu, move cursor to "MAIN" with ▲ or ▼ cursor buttons and press OK button.

SURROUND

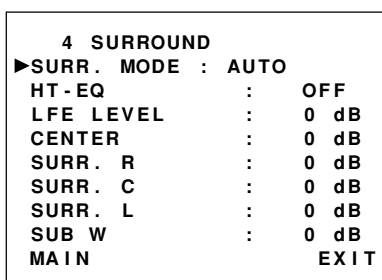

1. Select "SURROUND" in SETUP MAIN MENU with ▲ or ▼ cursor button, and press the OK button.
2. To select a desired content, press ▲ or ▼ cursor button.

SURR-MODE : Select the desired surround mode with ◀ or ▶ cursor button.

HT-EQ : Select to activate the HT (Home Theater)-EQ with ◀ or ▶ cursor button.

This mode compensates for the audio portion of a movie sounding "bright".

This equalizer is effective in Auto, DOLBY, DTS and SEREO mode.

LFE LEVEL : Select the output level of the LFE signal included in the Dolby Digital signal or the DTS signal.

Select 0dB, -10 dB or OFF with ◀ or ▶ cursor button.

Note: If LFE signal is too loud and subwoofer output is distorted, set LFE level to -10 dB.

CENTER : Adjust the volume level of the center speaker between -10 dB and +10 dB in 1 level interval with ◀ or ▶ cursor button.

SURR. R : Adjust the volume level of the surround right speaker between -10 dB and +10 dB in 1 level interval with ◀ or ▶ cursor button.

SURR. C : Adjust the volume level of the surround center speaker between -10 dB and +10 dB in 1 level interval with ◀ or ▶ cursor button.

SURR. L : Adjust the volume level of the surround left speaker between -10 dB and +10 dB in 1 level interval with ◀ or ▶ cursor button.

CS2 (CIRCLE SURROUND II) PARAMETER

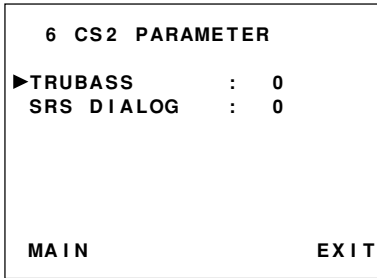

1. Select "CS2" in SETUP MAIN MENU with ▲ or ▼ cursor button, and press the **OK** button.
2. To Select desired contents as below, press ▲ or ▼ cursor button
 - TRUBASS:** Set the TRUBASS level between 0 and 6 level in 1 level interval with ◀ or ▶ cursor button. TRUBASS produced by the speakers to be an octave below the actual physical capabilities of the speakers adding exciting, deeper bass effects.
 - SRS DIALOG:** Set the SRS DIALOG level between 0 and 6 level in 1 level interval with ◀ or ▶ cursor button. This can be popped out of the surround audio effects allowing the listener to easily discern what the actors say. If "NONE" was selected for the Center speaker setting in the Speaker size, then this setting will not appear.

If you finish the setup in this menu, move cursor to "MAIN" with ▲ or ▼ cursor buttons and press **OK** button.

6.1 CH INPUT LEVEL

This sub-menu is to adjust the speaker levels for 6.1-channel input sources.

Here you will adjust the volume for each channel so that they are all heard by the listener at the same level.

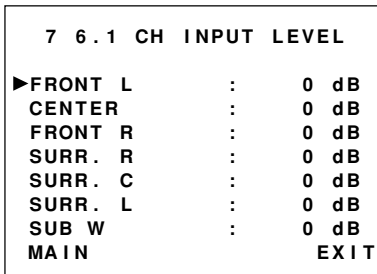

1. Select "6.1CH IN" in SETUP MAIN MENU with ▲ or ▼ cursor button, and press the **OK** button.
2. To Select desired channel , press ▲ or ▼ cursor button.
3. Using the ◀ or ▶ cursor buttons, adjust the volume level of each channel.
4. If you finish the setup in this menu, move cursor to "MAIN" with ▲ or ▼ cursor buttons and press **OK** button.

Note:

- The condition of these setup will be memorized to 6.1CH INPUT source.

BASIC OPERATION

LISTENING TO THE TUNER

MANUAL TUNING

1. To select the tuner as the source, press the **TUNER** button ⑤ on the front panel or press the **TUNER** button ⑲ on the remote.
2. Press the **TUNER** button ⑤ on the front panel or press the **TUNER** button ⑲ on the remote to select the desired frequency band if required.
3. Press the **F/P** button ⑮ on the front panel to display the frequency.
4. Press the **TUNING/PRESET ▲** or **▼** button ⑭ on the front panel or press the **TUNE/SEARCH ◀◀** or **▶▶** button ⑱ on the remote.
5. If FM is selected, press the **MODE** button ⑯ on the front panel or press the **T.MODE** button ⑪ on the remote control to select the desired audio mode.

(FM) MODE BUTTON OPERATION

When "AUTO" indicator is on in the display, FM stations that broadcast in stereo will be received in stereo and the "STEREO" indicator lights.

When "AUTO" indicator is off, all the FM stations will be received in mono regardless of whether or not they are broadcasting in stereo.

AUTO TUNING (USING THE SR6300)

1. Press the **F/P** button ⑮ on the front panel to display the frequency.
2. Press the **TUNING/PRESET ▲** or **▼** button ⑭ on the front panel for more than 1 second to start the Auto tuning function.

AUTO TUNING (USING THE REMOTE CONTROL UNIT)

Press **TUNE/SEARCH ◀◀** or **▶▶** button ⑱ for more than 1 second to start the Auto tuning function.

PRESET TUNING

With this unit you can preset up to 30 FM/AM stations in any order. For each station, you can memorize the frequency and reception mode if desired.

1-a. Manual Presetting (Using the SR6300)

1. Refer to the "MANUAL TUNING" or "AUTO TUNING" section above to tune in a desired station.
2. Press the **MEMORY** button ⑬. "MEMO" indicator starts blinking on the display.
While "MEMO" is still blinking (approx. 5 seconds), select the preset number by pressing the **TUNING/PRESET ▲** or **▼** button ⑭ then press the **MEMORY** button ⑬ again.
3. When a number has been properly input, "MEMO" indicator stops blinking and goes out.
The station is now stored in the specified preset memory location.

1-b. Manual Presetting (Using the remote control unit)

1. Tune in a desired station.
2. Press the **MEMO** button ⑳.
3. Enter the desired preset number with ten keypad ⑧.
4. Then, press **MEMO** button ⑳ again to store.

2. Auto Presetting

This function automatically scans the AM and FM band and enters all stations with sufficient signal strength into the memory.

1. Press and hold down the **MEMORY** button ⑬ and **TUNER** button ⑤ simultaneously, auto presetting will start.
2. "MEMO" will blink on the display.
3. Each time the tuner finds a station, the scanning will pause and memory. Auto presetting will starts.
4. Operation stops automatically when all 30 preset memory positions are filled or when auto scanning attains the highest end of all bands.
To stop the auto preset function at anytime, press the **CLEAR** button ⑫.

3. Recalling a Preset Station

1. Press the **F/P** button ⑮ to change the display to preset.
2. Select the desired preset station by pressing **TUNING/PRESET ▲** or **▼** button ⑭ on the front panel or press **CHANNEL/SKIP ◀◀** or **▶▶** button ⑱ on the remote.

Note:

- To directly access the preset stations using the numeric keypad, select the desired preset station by entering one or two digits using the numeric keypad ⑧.
- To return to the Manual Tuning mode, press the **F/P** button ⑮.

4. Preset Scan Tuning (Using the remote control unit)

1. Press the **P.SCAN** button ㉔ on the remote control. (The preset station with the smallest preset number is recalled first. If no stations have been preset, "NO PRESET" shows in the display and the unit returns to the previous mode.)
2. Preset stations are recalled in sequence (CH-1 → CH-2, etc.) for 5 seconds each. Preset numbers that do not contain stations are skipped.
3. You can fast forward the preset stations by pressing the **CHANNEL/SKIP ▶▶** button ⑱ continuously.
When the desired preset station is received, cancel the preset scan operation by pressing the **CHANNEL/SKIP ◀◀** button ⑱ or the **CL** button ⑨.

5. Clearing Preset Stations

You can remove preset stations from memory using the following procedure.

1. Recall the preset number to be cleared with the method described in "Recalling" a preset station .
2. Press the **CLEAR** button ⑫ on the front panel or **CL** button ⑨ on the remote control unit for 3 seconds or more.
"CLEAR" appears on the display to indicate that the specified preset number has been cleared.

6. Frequency Direct Call

1. Press **F.DIR/SEAR** button ㉔ in the TUNER mode on the remote controller.
2. Display shows "FM- --. -- MHz" (at FM mode).
3. Input your desired frequency with tenkeypad buttons on the remote controller.
Eg) 98.1 MHz
Press **9, 8, 1** and **0**
4. Display fixed 98.10 MHz and broadcast station received.

STATION NAME PRESET (On PRESET display mode)

The station name preset function allows the name of each preset channel to be entered using alphanumeric characters. The Station Name button is valid only in the tuner mode. Before station name preset operation, store stations with the preset memory operation.

1. Press the **MEMORY** button [13] on the front panel or **MEMO** button [26] on the remote for more than 3 seconds.
2. The left most column of the station name indicator flashes, indicating the character entry ready status.

[Operation (Using the SR6300)]

3. When you press the **TUNING/PRESET** ▲ or ▼ buttons [14] is turned, alphabetic and numeric characters will be displayed in the following order:
A → B → C ... Z → 1 → 2 → 3... 0 → - → + → / → (Blank) → A
 UP →
 ← DOWN
4. After selecting the first character to be entered, press the **MEMORY** button [13]. The entry in this column is fixed and the next column starts to flash. Fill the next column and press the **MEMORY** button [13] for more than 1 second to confirm the entry.

[Operation (Using the remote control unit)]

First, press the **TUNER** button [19] on the remote control unit. (This operation is not necessary if the remote control unit has already been operated in the TUNER mode.)

3. Enter the character using the ten keypad [8]. For example, to enter "A":
 1) Press the "1" button. "A" appears on the display column.
 2) Every time the 1 button is pressed, the displayed character changes in the order: **A → B → C → 1 → A...**
 Pressing buttons other than the "1" button cause different characters to be displayed in a similar way, so that other alphanumeric characters can be entered. To enter a blank or space, press the "9" button.
4. When the desired character is displayed, press the **MEMO** button [26] to confirm the entry in this column and move to the next column. After having filled all of the 8 columns, press the **MEMO** button [26], for more than 1 second to confirm the entry.

RDS OPERATION

Now in use in many countries, RDS (Radio Data System) is a description of the station's programming hidden space in the FM signal. Your new receiver is equipped with RDS to assist in the selection of FM stations using station and network names, rather than broadcast frequencies. Additional RDS functions include the ability to search for programme types.

RADIO TEXT

Some RDS stations broadcast RADIO TEXT, which is additional information on the station and programme being broadcast. RADIO TEXT information appears as 'running' text in the display. RADIO TEXT is transmitted character-by-character by the radio station. As a result of that it may take some time until the entire text has been completely received.

RDS DISPLAY

When a receiver is tuned to an FM station that is transmitting RDS data, the Front Panel Information Display will automatically show the station name or RDS TEXT in place of the typical display of the station's broadcast frequency. To change the display, press the **DISP./RDS** button [30] on the remote controller.

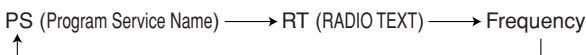

PROGRAMME TYPE (PTY) DISPLAY

The RDS system categorizes programmes according to their genre into different programme type (PTY) groups. To display the programme type information of the current station, press the **PTY** button [28] in the TUNER MODE on the remote controller.

PTY AUTO SEARCH

Your receiver is equipped to automatically search for stations transmitting any of 29 different programme types. To search for a PTY, follow these procedures:

1. Press the **PTY** button [28] in the TUNER MODE on the remote controller. The current station's PTY will be displayed, or the currently selected PTY group will be displayed in blinking if no station or RDS data is present.
2. To change to a new PTY type, press the **CHANNEL/SKIP** I◀◀ ▶▶ button [18] until the desired PTY is shown in the display.
3. Once the desired PTY group or type has been selected, press the **PTY** button [28] while the display blink (approx. 5 seconds). The PTY Auto search will start, and the tuner will pause at each station broadcasting RDS PTY information corresponding to the selected choice.
4. To advance to the next RDS station with the desired PTY, press the **PTY** button [28] again within 5 seconds.

NUMBER	DISPLAY	PROGRAMME TYPE
1	POP	Pop Music
2	ROCK	Rock Music
3	MOR	M. O. R. Music
4	LIGHT	Light classical
5	CLASSIC	Serious classical
6	NEWS	News
7	AFFAIR	Current Affairs
8	INFO	Information
9	SPORT	Sport
10	EDUCATE	Education
11	DRAMA	Drama
12	CULTURE	Culture
13	SCIENCE	Science
14	OTHERS	Varied
15	OTHER	Other Music
16	WEATHER	Weather
17	FINANCE	Finance
18	CHILDREN	Children's programmes
19	SOCIAL	Social Affairs
20	RELIGION	Religion
21	PHONE IN	Phone In
22	TRAVEL	Travel
23	HOBBIES	Hobbies
24	JAZZ	Jazz Music
25	COUNTRY	Country Music
26	NATION	National Music
27	OLDIES	Oldies Music
28	FOLK	Folk Music
29	DOCUMENT	Documentary

PLAYBACK OPERATION

NORMAL PLAYBACK

1. Press the **POWER** button ① / 34.
2. Press the desired **FUNCTION SELECTOR** button ⑤ on the front panel or press the desired **FUNCTION** button 19 on the remote unit to select an input source.
3. Turn the **SURROUND MODE SELECTOR** knob ③ on the front panel or Surround mode buttons 8 in the AMP MODE on the remote unit to select the desired surround mode.
4. Adjust the volume level using the **VOLUME** knob ④ on the front panel or press the **VOL.** button 23 on the remote. If necessary, adjust the tone, press the **TREBLE▲**, **TREBLE▼** 14 and **BASS▲**, **BASS▼** 14 on the remote unit.

Note:

- In case of remote control operation, press one of the function buttons twice within 2 seconds to select the function.

LISTENING TO A DIFFERENT AUDIO SOURCE WHILE WATCHING A VIDEO SOURCE (Using the remote control unit)

1. Select one of the following video sources
TV, DVD, VCR1, DSS/VCR2 or AUX.
2. Next, select one of the following audio sources
FM, AM, CD, TAPE, or CDR/MD.

TV AUTO ON/OFF FUNCTION

This function allows the component connected to the TV IN jack to control the power (ON/OFF) to the SR6300.

AUTO POWER ON

1. Be sure TV auto mode is enable. (Refer page 19 : PREFERENCE)
2. Connect your TV TUNER (etc) to the TV IN terminal.
Be sure to connect the video input.
3. Turn OFF the power to the TV TUNER and the SR6300 will be in standby mode.
4. Turn ON the TV TUNER and tune in a receivable station.
5. When the station is received, the SR6300 turns ON and TV is selected automatically.

AUTO POWER OFF

1. In the above situation, turn the TV TUNER OFF or select a channel that does not contain any broadcast.
2. The SR6300 switches to STANDBY after approximately 5 minutes.

Note:

- AUTO POWER OFF is canceled if the **FUNCTION SELECTOR** button ⑤ is set to a source other than TV. The function reactivates when TV is selected again.

Caution:

- Some TV broadcasts may cause the TV AUTO FUNCTION to turn on.
- S-Video terminal does not support "TV AUTO ON/OFF" function.

SETTING THE SLEEP TIMER

Set the sleep timer while the power is turned on.

1. Turn the power ON and press the **SLEEP** button 9 / 32.
2. Press the **SLEEP** button 9 / 32 the number of times to set the desired sleep time in minutes.

Each press of the **SLEEP** button 9 / 32 or changes the display in the following order:

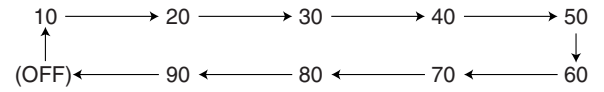

The unit will shut off in the number of minutes indicated.

- * While the sleep timer is activated, the remaining time can be displayed for approximately 2 seconds by pressing the **SLEEP** button 9 / 32.
- * To cancel the Sleep timer, press the **SLEEP** button 9 / 32 until the display shows to "SLEEP OFF" and the SLEEP indicator disappear.

ADJUSTING THE SURROUND LEVEL

Adjust the volume level of speakers depend on your preference.

1. Press the **CH SEL** button 16 in the AMP mode on the remote controller.
"SURROUND" will be displayed.
2. To select a desired speaker channel with ▲ or ▼ cursor button.

4 SURROUND		
SURR. MODE :	AUTO	
HT - EQ	:	OFF
LFE LEVEL	:	0 dB
▶CENTER	:	0 dB
SURR. R	:	0 dB
SURR. C	:	0 dB
SURR. L	:	0 dB
SUB W	:	0 dB
MAIN		EXIT

3. Adjust the volume level of speaker with press ◀ or ▶ cursor buttons.
4. To exit from surround menu, press the **CH SEL** button 16 again, or move cursor to "EXIT" with ▲ or ▼ cursor button and press OK button.



Note:

- When 6.1CH INPUT function is turned on, it will display "6.1 CH INPUT LEVEL" by pressing the **CH SEL** button 16.

ON SCREEN DISPLAY INFORMATION

The on-screen display, which can be activated by the Main unit or remote, appears on the TV screen to show the current setting status of the SR6300.

Note:

- SR6300 can set PAL or NTSC for TV format of OSD.
If this setup does not meet the video input signal, character of OSD can not synchronize.
So You can select these format function by function.
Press **MENU/OSD** button  on the remote controller for 3 seconds or more. "PAL" or "NTSC" will be shown on the display of SR6300, press **MENU/OSD** button  again to change the TV format.
The indication on FL display will change " PAL" → " NTSC" → "PAL"→.

1. GENERAL INFORMATION

When the **MENU/OSD** button  is pressed, the current setting are displayed on the TV monitor.
This display disappears automatically in about 5 seconds after the button is pressed.

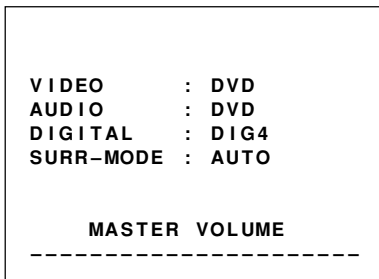

① **VIDEO SOURCE:**

Displays the current video source being selected with the function selector **TV, DVD, VCR1, DSS** or **AUX**.

② **AUDIO SOURCE:**

Displays the current audio source being selected with the function selector **FM, AM, CD, TAPE, CD-R, TV, DVD, VCR1, DSS** or **AUX**.

③ **DIGITAL INPUT:**

Displays the digital input that you are using **DIG-1, DIG-2, DIG-3, DIG-4** or **DIG-5**.

④ **SURROUND MODE:**

Displays the current surround mode
AUTO, DOLBY D, DOLBY D EX, PLII MOVIE, PLII MUSIC, PRO LOGIC, DTS, DTS ES, NEO6 CINEMA, NEO6 MUSIC, MULTI CH. ST, CS2 CINEMA, CS2 MUSIC, CS2 MONO, VIRTUAL, MOVIE, HALL, STADIUM, MATRIX, STEREO

Note:

- Not all modes will be present depend on selected input.

⑤ **MASTER VOLUME**

Displays the current volume level.
The volume level is higher at the right of the display.

Notes:

- The On-Screen Display signals can be output from the TV MONI composite video (RCA) output and the TV MONI S-Video output jacks.
- When you connect both the composite video and S-VIDEO, there will be no signal output from composite video jack.
- With some video equipment or software, the On-Screen Display characters may be distorted due to noise or tracking adjustment error.

2. FUNCTION SELECT & SURROUND MODE

- When a function selector button or surround mode button is pressed
VIDEO: Displays the current video source. When TV, DSS, DVD, VCR1 or AUX is selected with the function selector, both AUDIO and VIDEO shows the same name.
AUDIO: Displays the current analog audio input source.
DIGITAL: Displays the current digital input source.
SURR-MODE: Displays the current Surround mode.

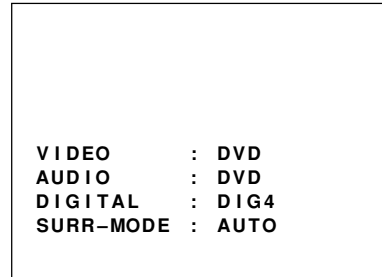

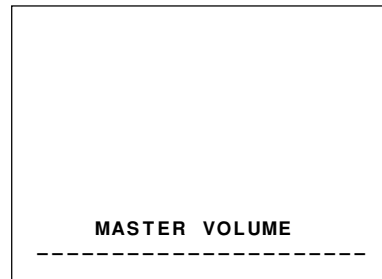

3. MASTER VOLUME CONTROL

Displayed when the MASTER volume is varied or a button of the remote control unit is pressed.





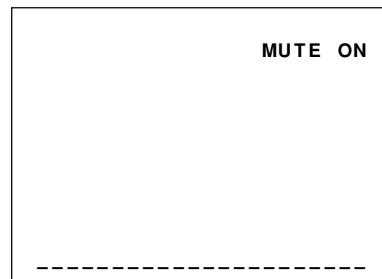

4. MUTE

When the **MUTE** button  is pressed, "MUTE ON" will be shown on screen.
Pressing **MUTE** button  again will show "MUTE OFF" on screen, and return to the previous volume level.



5. SLEEP TIMER

When the **SLEEP** button  /  is pressed, the setting on or off and the remaining time of the sleep timer function are displayed.
You can change the mode between on, off and the amount of time to elapse before the unit will shut itself off by cycling the **SLEEP** button  / .



REMOTE CONTROLLER OPERATION

CONTROLLING THE SR6300

IN TUNER MODE

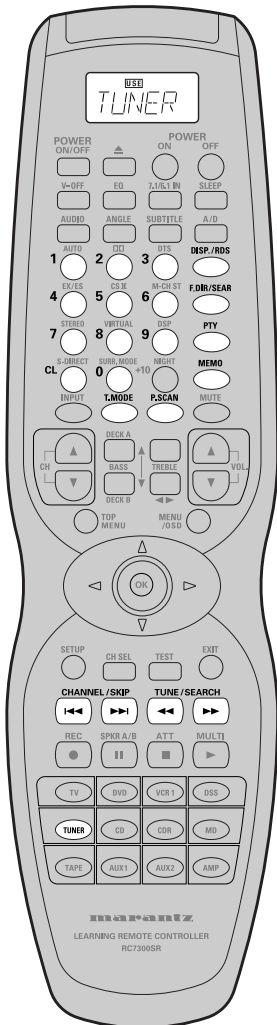

0-9	Inputs the numeric
DISP./RDS	Selects the display mode in RDS
F.DIR/SEAR	Selects the "Frequency direct input"
PTY	Displays the programme type information of the current station
MEMO	Enters the tuner preset memory numbers
CL	Clears the inputting
T.MODE	Selects the auto stereo mode or mono mode
P.SCAN	Starts preset scan
CHANNEL/SKIP	<ul style="list-style-type: none"> Selects a preset station Changes a PTY type
TUNE/SEARCH	Tunes a station
TUNER	Selects a frequency band

CONTROLLING MARANTZ COMPONENTS

- Press the desired function button [19].
 - The selected function name and **USE** are displayed in LCD.
- Press the desired operation buttons to play the selected component.
 - For details, refer to the components's user guide.
 - It may not be possible to operate some models.

CONTROLLING A MARANTZ DVD PLAYER (DVD MODE)

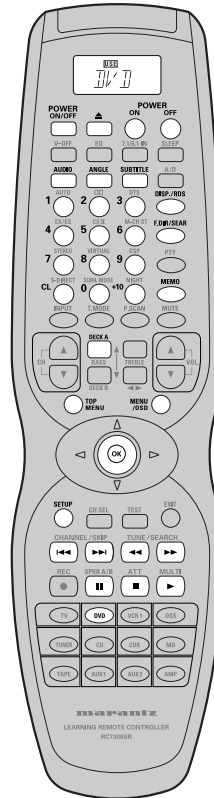

POWER ON/OFF	Turns the DVD player on and off
POWER ON	Turns the DVD player on
POWER OFF	Turns the DVD player off
▲	Opens / closes the disc tray
AUDIO	Selects the audio language
ANGLE	Selects the camera angle
SUBTITLE	Selects the subtitle language
0 - 9,+10	Inputs the numeric
DISP	Displays the disc information
F.DIR/SEAR	Searches the title or track
CL	Clears the inputting
MEMO	Calls up programming menu
DECK A	Next disc tray
TOP MENU	Calls up the top menu of the DVD disc
MENU/OSD	Calls up the menu of the DVD disc
Cursor, OK	Moves the cursor, enters the setting
SETUP	Calls up the setup menu of the DVD player
◀◀ / ▶▶	Skips forward or previous chapter/track
◀◀ / ▶▶	Searches forward or backward
⏸	Pause
■	Stop
▶	Play

CONTROLLING A MARANTZ VCR (VCR1 MODE)

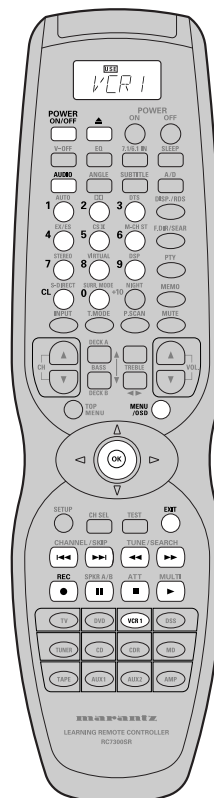

POWER ON/OFF	Turns the VCR on and off
▲	Ejects the tape
AUDIO	Selects the audio language
0 - 9	Inputs the numeric
CL	Clears the inputting
MENU/OSD	Calls up the menu
Cursor, OK	Moves the cursor, enters the setting
EXIT	Exits the programming menu
◀◀ / ▶▶	Skips forward or previous track
◀◀ / ▶▶	Searches forward or backward
●	Record
⏸	Pause
■	Stop
▶	Play

CONTROLLING A MARANTZ CD PLAYER (CD MODE)

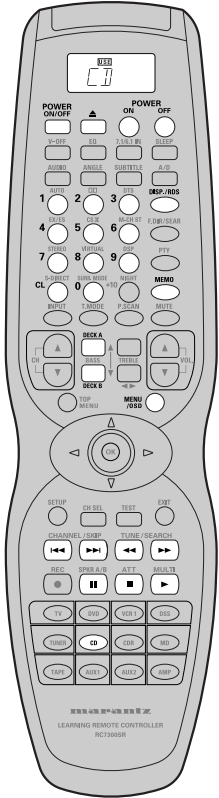

POWER ON/OFF	Turns the CD player on and off
POWER ON	Turns the CD player on
POWER OFF	Turns the CD player off
▲	Opens / closes the disc tray
0 - 9	Inputs the numeric
DISP	Scrolls the disc information
CL	Clears the inputting
MEMO	Programes
DECK A, B	Changes the disc tray
MENU/OSD	Switches the display information
⏮ / ⏭	Skips forward or previous track
⏪ / ⏩	Seachs forward or backward
⏸	Pause
■	Stop
▶	Play

CONTROLLING A MARANTZ MD DECK (MD MODE)

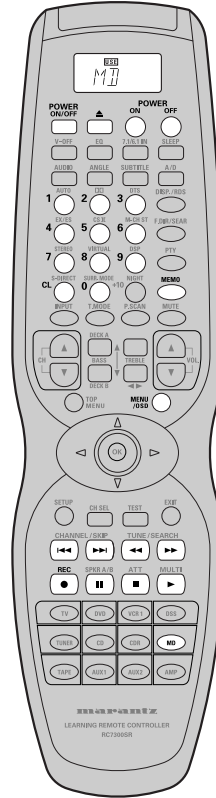

POWER ON/OFF	Turns the MD deck on and off
POWER ON	Turns the MD deck on
POWER OFF	Turns the MD deck off
▲	Eject the MD disc
0 - 9	Inputs the numeric
CL	Clears the inputting
MEMO	Programes
MENU/OSD	Switches the display information
⏮ / ⏭	Skips forward or previous track
⏪ / ⏩	Seachs forward or backward
●	Record
⏸	Pause
■	Stop
▶	Play

CONTROLLING A MARANTZ CD RECORDER (CDR MODE)

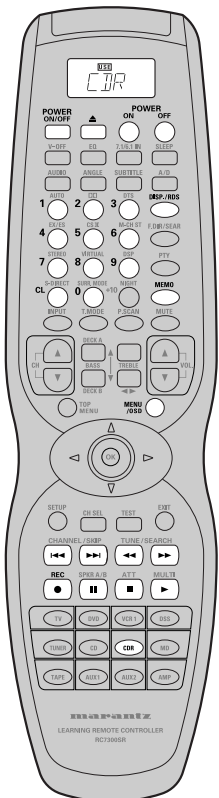

POWER ON/OFF	Turns the CD recorder on and off
POWER ON	Turns the CD recorder on
POWER OFF	Turns the CD recorder off
▲	Opens / closes the disc tray
0 - 9	Inputs the numeric
DISP	Switches the display information
CL	Clears the inputting
MEMO	Programes
MENU/OSD	Scrolls the disc information
⏮ / ⏭	Skips forward or previous track
⏪ / ⏩	Seachs forward or backward
●	Record
⏸	Pause
■	Stop
▶	Play

CONTROLLING A MARANTZ TAPE DECK (TAPE MODE)

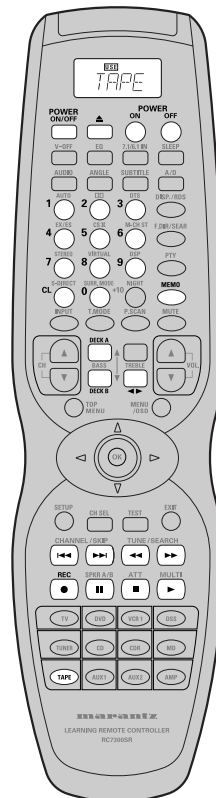

POWER ON/OFF	Turns the tape deck on and off
POWER ON	Turns the tape deck on
POWER OFF	Turns the tape deck off
▲	Eject the tape
0 - 9	Inputs the numeric
CL	Clears the inputting
MEMO	Programes
DECK A B	Changes the tape deck
◀ ▶	Changes the direction
⏮ / ⏭	Skips forward or previous track
⏪ / ⏩	Seachs forward or backward
●	Record
⏸	Pause
■	Stop
▶	Play

LEARN MODE

The remote controller is capable of learning and memorizing the remote control codes used by almost any other remote controller you may already own.

- If no commands have been programmed for a particular function button, the remote controller will transmit whatever codes have been factory preset.
- The following example shows how to program your remote controller and how to use the codes for a DVD player.

LEARNING PROCEDURE

1. Place the remote controller so that its infrared signal transmitter is facing the infrared signal receiver on the Marantz remote controller at a distance of about 5 centimeters.

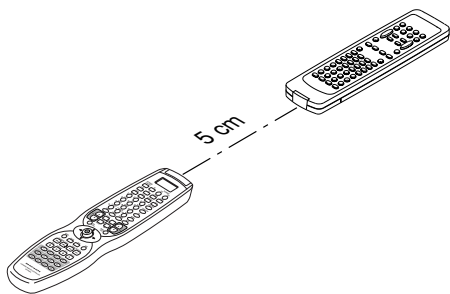

2. Press and hold down the **T.MODE** [11] and **MEMO** [26] buttons until **LEARN** is displayed in the display.



3. Select the function button to select the function.
 - Selected function is displayed and **LEARN** is blinking.



4. Select the button to be learned.
 - **LEARN** is displayed.



5. Press and hold the button of the original remote controller to learn until **OK** in the display.
 - When **NG** is displayed, repeat this step.
 - When **FULL** is displayed, the memory of the RC7300SR is full. If you want to learn the code, you should erase other learned button.

6. Repeat steps 4 and 5 to learn other buttons in same function.

7. Repeat steps 3 to 6 to learn other function.

8. When you have finished programming the remote controller, press and hold down the **OK** button [15] until **USE** is displayed in the display.



Note:

- When NG is displayed in step 5 again, the transmitting code is unavailable for RC7300SR, or the transmitting signal is intercepted by noise.
- If no buttons are pressed for approximately 1 minutes while in the LEARN mode, the remote controller automatically returns to the use mode.

ERASING LEARNING CODE

Erasing the code by buttons

1. Press and hold down the **T.MODE** [11] and **MEMO** [26] buttons until **LEARN** is displayed in the display.



2. Select the function button to select the button to be erased.
 - Selected function is displayed and **LEARN** is blinking.

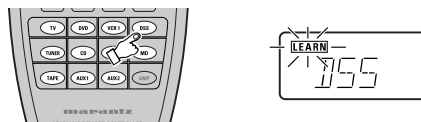

3. Press and hold down the **CL** button [9] and press the learned button twice to be erased.
 - **CLR** is displayed for 3 seconds and the mode returns to LEARN mode.



4. To return the USE mode, press and hold down the **OK** button [15] until **USE** is displayed in the display.

Erasing the code by functions

1. Press and hold down the **T.MODE** [11] and **MEMO** [26] buttons until **LEARN** is displayed in the display.



2. Press and hold down the **CL** button [9] and press the learned function button twice to be erased.
 - **F-CLR** and **LEARN** are blinking.

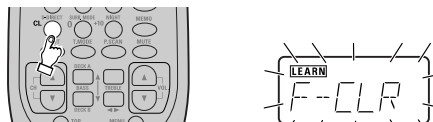

3. Press **OK** [15] button to continue erasing.
 - **F-CLR** is displayed for 3 seconds and the mode returns to LEARN mode.
 - To cancel the erasing operation, do not press **OK** button [15] and simply touch any other button.

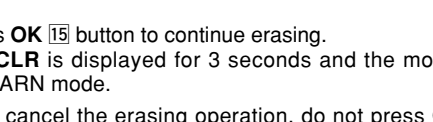

4. To return the USE mode, press and hold down the **OK** button [15] until **USE** is displayed in the display.



4. To return the USE mode, press and hold down the **OK** button [15] until **USE** is displayed in the display.

Erasing the all functions

1. Press and hold down the **T.MODE** [11] and **MEMO** [26] buttons until **LEARN** is displayed in the display.

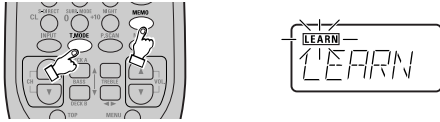

2. Press and hold down the **CL** [9] button and press **POWER ON** [34] and **POWER OFF** [34] button.
 - **A-CLR** and **LEARN** are blinking.

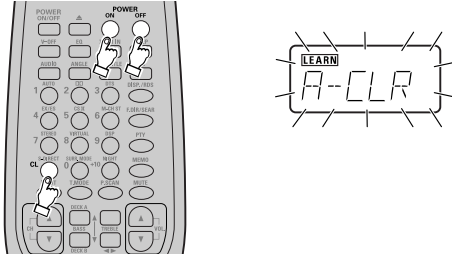

3. Press **OK** [15] button to continue erasing.
 - **A-CLR** is displayed for 3 seconds and the mode returns to **LEARN** mode.
 - To cancel the erasing operation, do not press **OK** button [15] and simply touch any other button.



4. To return the **USE** mode, press and hold down the **OK** button [15] until **USE** is displayed in the display.

Note:

- Erasing codes will return to the factory preset code, or there will leave empty if the button has no factory preset code.

MACRO MODE

PROGRAMMING MACROS

Macros make it possible to use a single function button to perform more complex series of operations that would normally require pressing several buttons. A single button can be programmed to perform up to 10 steps in sequence. A typical example of such a series might be as follows:

- Turn the main amplifier power ON → Switch the function to DVD → Set the Surround Mode to Virtual → Set the DVD player to PLAY.
- No signals may be transmitted during macro programming.
- The various steps that make up a macro are set initially to be sent one after another in 1 second intervals, however these intervals may be shortened to as little as 0.5 seconds or lengthened to as much as 5 seconds using the Setup mode.
- In the macro mode, the number of steps the macro is displayed the following selected function name.
- Macros may be programmed for each of the 12 function buttons as follows;
TV, DVD, VCR1, DSS, TUNER, CD, CDR, MD, TAPE, AUX1, AUX2, AMP

1. Press and hold the **T.MODE** [11] and **MENU** button [22] until the **MACRO** is displayed.
 - **MACRO** and **LEARN** indicators are displayed blinking on the LCD, too.

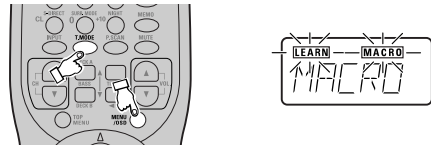

2. Press the **Function** button [19] for which you wish to program a series of operations.

In this case, let's use the example of the DVD player.

Press the **DVD Function** button [19]. The LCD will display DVD-M.

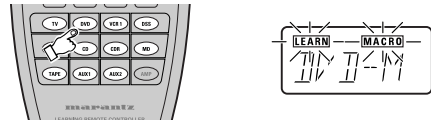

Characters displayed on LCD include the following, depending on the function button for which the macro is being programmed:
TV-M, DVD-M, VCR-M, DSS-M, TUN-M, CD-M, CDR-M, MD-M, TAP-M, AX1-M, AX2-M, AMP-M

- If a macro has already been set for the selected function button, the LCD will blink.

3. Press the buttons for the operations you wish to program as a macro in the sequence you want the macro to program them.

For example, press DVD, PLAY.

- The number of steps in the macro is displayed on LCD and this number increases by 1 with each button pressed.
- Each function button can be programmed to perform up to 10 steps in sequence.



- When you are finished programming macros, press and hold the **OK** button [15] until the display returns to USE mode.

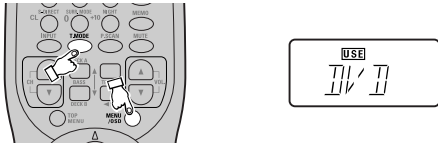

- Macros cannot be programmed for the **MEMO** [26], **cursor/OK** [15], **VOL ▲/▼** [23] or **CL** [9] buttons.

In the macro mode it is possible to program the memory to perform macros containing up to 10 steps.

- Each of the function operations (12 including CD, CD-R, etc.) can be used in a macro more than once, however for all except AMP, only the first function operation will be transmitted as a signal from the remote controller. Accordingly, within a single macro, it is not possible to switch between multiple function operations. (This is to prevent the switching of the receiver function operation.) Within a macro, the second time a function operation is used, it will only be used on the remote controller itself and no signal will be transmitted to the component.

Note:

- If, while programming, no buttons are pressed for approximately 1 minute, the remote controller will automatically return to normal mode, and no macro will be programmed in the memory.

CONFIRMING MACROS

Macros may be confirmed using following procedure.

- Press and hold the **T.MODE** [11] and **MENU** button [22] until the **MACRO** is displayed on the LCD.
 - **LEARN** and **MACRO** is displayed blinking.

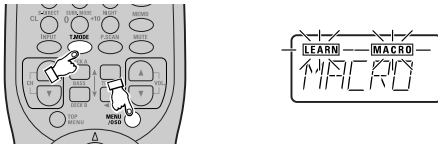

- Press the **Function** button [19] to be confirmed. Let's use the example of the DVD player, by pressing the **DVD Function** button [19].
 - **DVD-M, LEARN** and **MACRO** is displayed blinking.



- Press the **VOL ▲** button [23].
 - **DVD-1** is displayed and **LEARN** is disappeared.
 - The programmed operation is transmitting.



- Repeat step 3. until the last number of the macro is displayed.
 - The display will return to step 1.
 - The each programmed operation is transmitting when the number of the macro is displayed.
- To return the USE mode, press and hold down the **OK** button [15] until **USE** is displayed in the display.

EDITING MACROS

Macros may be edited using following procedure.

- Press and hold the **T.MODE** [11] and **MENU** button [22] until the **MACRO** is displayed on the LCD.
 - **LEARN** and **MACRO** is displayed blinking.

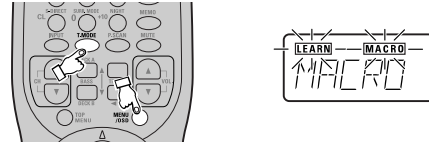

- Press the **Function** button [19] to be changed. Let's use the example of the DVD player, by pressing the **DVD Function** button [19].
 - **DVD-M, LEARN** and **MACRO** is displayed blinking.

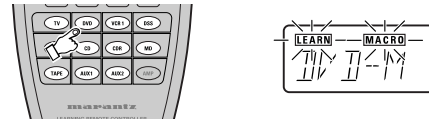

- Press the **Cursor ▲/▼** button [15] to select the number of macro to be edited.
 - The programmed operation is displayed after the number of macro is displayed.
 - The number of macro can be changed with the cursor ▲/▼ button [15].
 - To rewrite an existing macro step, simply press the button for the new step. The old step will be erased and rewritten with the new step.
 - To insert a new step in between existing steps in a macro, after step 3 press the **MEMO** button [26], then press the button for the new step. The numbers of the other steps will be adjusted accordingly to accommodate the new step. Since only 10 steps may be stored in any macro, the tenth step will be erased if an step is inserted when the total number of steps is already 10.
 - To erase a step in a macro, after step 3 call up the number of the step to be erased and press the **CL** button [9].

- Press the **OK** button [15] to return step 1.
- To return the USE mode, press and hold down the **OK** button [15] until **USE** is displayed in the display.

USING MACROS

The following procedure will show how to use the function buttons for which you have programmed macros.

- Press the **Function** button [8] for the desired macro for 3 seconds.
 - **MACRO** is displayed on LCD for approximately 1 second, after which the number of steps in the macro is displayed on LCD.

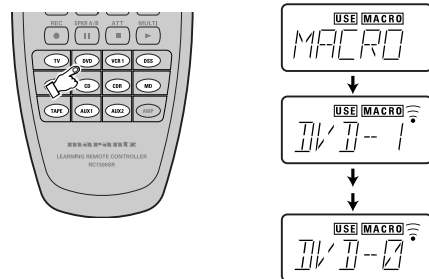

- The remote controller will do nothing if no macros are programmed. The macro steps are executed in order and the names of their buttons are displayed on the LCD. Also, the step numbers displayed on LCD @ disappear as each step is executed.

- After all macro commands have been transmitted, the remote controller returns to AMP in use mode.



EXAMPLES OF MACRO PROGRAMS

Example 1

Change the input source for the amplifier to CD and play the 3rd track on a CD in the CD player.

1. Press and hold the **T.MODE** [11] and **MENU** button [22] until the **MACRO** is displayed on the LCD.
 - **LEARN** and **MACRO** is displayed blinking.

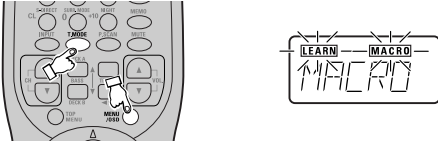

2. Press the **CD Function** button [19]. CD-M is displayed on the LCD.

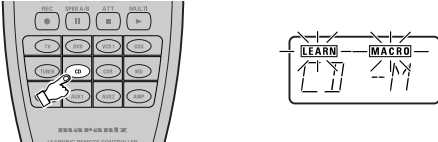

3. Press **CD** [19], **3** [8], and **▶** [18] buttons.

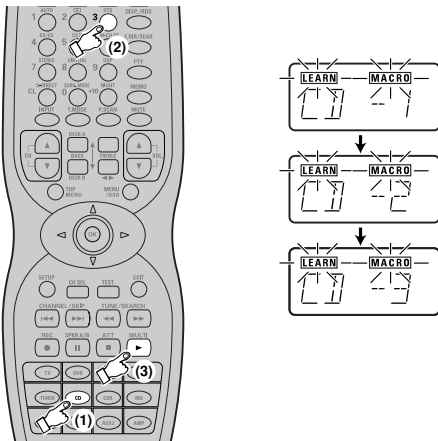

4. When you are finished programming the macro, press the **OK** button [15] until the display returns to USE mode.



Now, execute the macro you just programmed.

1. Press the **CD Function** button [19] for 3 seconds.

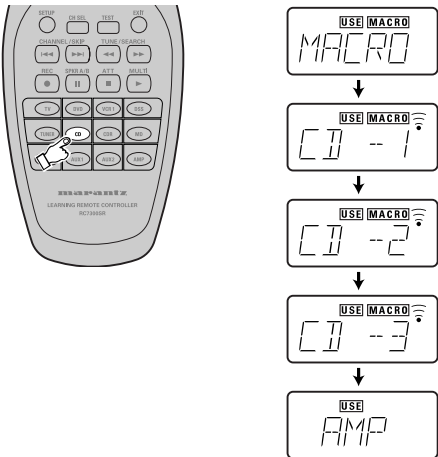

- The macro commands are transmitted to the components in order, and the steps of the operations are displayed on the LCD in order.

Example 2

Turn the main amplifier ON → Change the amplifier's input source to DVD → Set the Surround mode to VIRTUAL → Set the DVD player to PLAY

1. Press and hold the **T.MODE** [11] and **MENU** button [22] until the **MACRO** is displayed on the LCD.
 - **LEARN** and **MACRO** is displayed blinking.

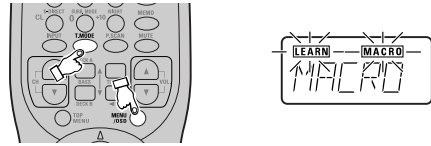

2. Press the **DVD Function** button [19].
 - Here the **DVD Function** button [19] is used as the macro button, but any function button can in fact be used.



3. To set the various steps of the macro, press the following buttons in order:
 - (1) **AMP***[19] → (2) **POWER ON** [39] → (3) **DVD** [19] → (4) **AMP***[19] → (5) **8** (VIRTUAL) [8] → (6) **DVD*** [19] → (7) **▶** [18].

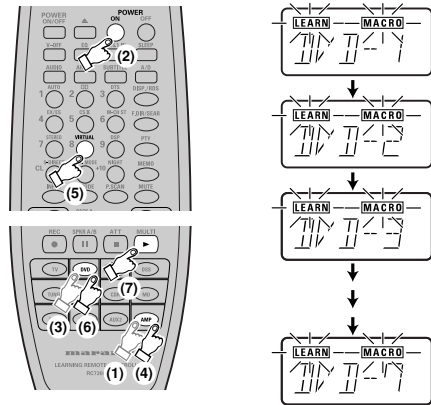

4. When you are finished programming the macro, press the **OK** button [15] until the display returns to USE mode.



Now, execute the macro you just programmed.

1. Press the **DVD Function** button [8] for 3 seconds.

The macro commands are transmitted in order, and the steps of the operations are displayed on LCD in order.

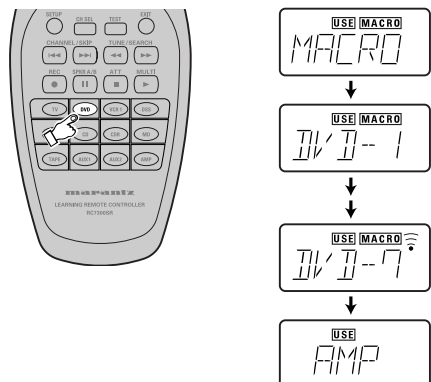

- When executing this macro, function operations AMP* and DVD* only switch the command set of the remote controller and no signal is transmitted to the component.

CLEARING MACRO PROGRAMS

The following procedure is used to erase macros you have programmed into the remote controller's memory.

1. Press and hold the **T.MODE** [11] and **MENU** button [22] until the **MACRO** is displayed on the LCD.
 - **LEARN** and **MACRO** is displayed blinking.

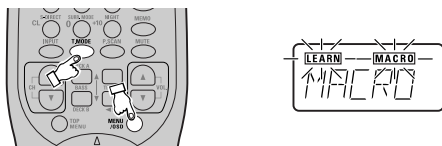

2. Press and hold the **CL** button [9], then the button for the **function** [8] to be cleared (in this case DVD) for 3 seconds.

DVDCL will appear on LCD.

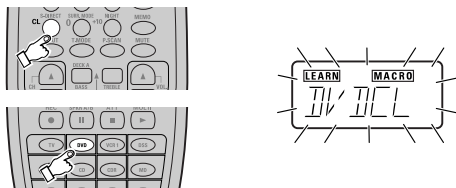

3. Press the **OK** button [15] to clear and return step 1.
 - To cancel the memory clearing operation, do not press **OK** button [15] and simply touch any other button.



4. To return the **USE** mode, press and hold down the **OK** button [15] until **USE** is displayed in the display.

ADJUSTING THE INTERVAL TIME OF MACRO OPERATIONS TRANSMITTING

1. Press and hold the **T.MODE** [11] and **SETUP** button [17] until the **SETUP** is displayed on the LCD.
 - **SETUP** is displayed for 3 seconds

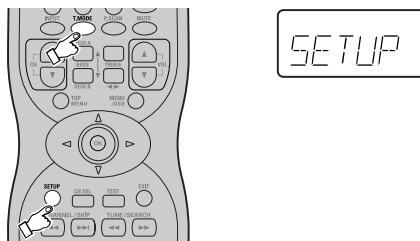

2. Confirm the display changes from **SETUP** to **MCRxx**. ("xx" means the interval time of macro operations transmitting)



3. Press the **Cursor** ◀/ ▶ button [15] to change the interval time.
 - The interval time can be changed from 0.5 to 5 seconds by 0.5 seconds step.

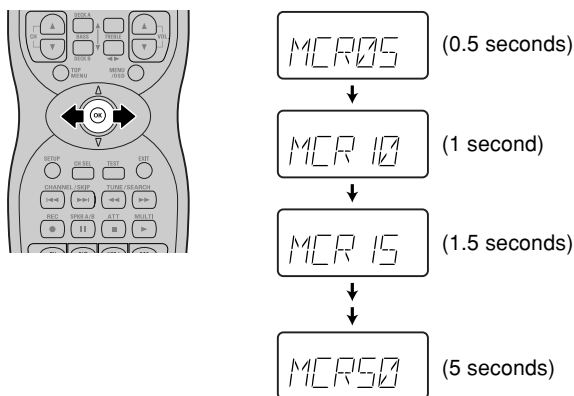

4. Press and hold down the **OK** button [15] until **USE** is displayed in the display.



SURROUND MODE

The SR6300 is equipped with many surround modes. These are provided to reproduce a variety of surround sound effects, according to the content of the source to be played.

The available surround modes may be restricted depending on the input signal and speaker setup.

AUTO

When this mode is selected, the receiver determines whether the digital input signal is Dolby Digital, Dolby Digital Surround EX, DTS, DTS-ES or PCM-audio.

Surround EX & DTS-ES will operate for multi channel source that has a Dolby Digital Surround EX or DTS-ES auto trigger flag in the digital signal.

When a Dolby Digital or DTS signal is input, the number of channels for which the corresponding signal is encoded will be played.

Inputting a Dolby Digital two channel signal with Dolby surround status automatically subjects that signal to Pro Logic II movie processing before play.

PCM 96 kHz source material can be played in this mode.

Notes:

- When you use this mode with certain DVD and CD players, performing operations such as "Skip" or "Stop" may momentarily interrupt the output.
- When the signal is not decoded is input for using mode, the mode is changed to AUTO mode automatically. Refer to page 34 to confirm the available decoding mode.

DI MODE

(Dolby Digital, Pro Logic II MOVIE, Pro Logic II MUSIC, PRO LOGIC)

This mode is used with source materials encoded in Dolby Digital and Dolby Surround.

DOLBY DIGITAL

This mode is enabled when playing source materials encoded in Dolby Digital.

Playing multi-channel encoded 5.1-channel Dolby Digital sources provides five main audio channels (left, center, right, surround left and surround right) and Low Frequency Effect channel.

Dolby Digital EX decoding is not available in this mode.

Dolby Pro Logic II brings the excitement of surround sound to any stereo mix, while making existing Dolby Surround mixes sound more like discrete 5.1 channels Surround sound.

Dolby Pro Logic II has below 3 modes.

Pro Logic II MOVIE

This mode provides 5.1 channel surround sound from Dolby Surround encoded stereo movie sound tracks.

Pro Logic II MUSIC

This mode provides 5.1 channel surround sound from conventional stereo sources, analog or digital, such as CD, tape, FM, TV, stereo VCR, etc.

PRO LOGIC

This mode emulated original Dolby Pro Logic decoding (3/1 surround) suit for Dolby Surround encoded stereo movie soundtracks.

Notes:

- Pro Logic II mode is available to 2ch input signal which is encoded Dolby Digital or PCM format.
- PCM-audio signals can be subjected to Pro Logic processing when the sampling frequency is 32 kHz, 44.1 kHz or 48 kHz.

EX/ES

This mode provides 6.1 channel surround for DOLBY DIGITAL EX, DTS-ES encoded source material such as DVD.

This mode cannot be used when an analog input has been selected.

Dolby Digital EX

In a movie theater, film soundtracks that have been encoded with Dolby Digital surround EX technology are able to reproduce an extra channel which has been added during the mixing of the program.

This channel, called Surround Center, places sounds behind the listener in addition to the currently available front left, front center, front right, surround right, surround left and subwoofer channels.

This additional channel provides the opportunity for more detailed imaging behind the listener and brings more depth, spacious ambience and sound localization than ever before.

Dolby Digital EX is not available in the system without surround center speaker(s).

DTS-ES (Discrete 6.1, Matrix 6.1)

DTS-ES adds the surround center channel audio to the DTS 5.1-channel format to improve the acoustic positioning and makes acoustic image movement more natural with the 6.1-channel reproduction.

This receiver incorporates a DTS-ES decoder, which can handle DTS-ES Discrete-encoded and DTS-ES Matrix-encoded program sources from DVD, etc..

DTS-ES Discrete 6.1 features digital discrete recording of all channels including the surround center channels and higher quality of audio reproduction.

DTS-ES is not available in the system without surround center speaker.

dts MODE

(dts, Neo:6 Cinema, Neo6: Music)

This mode is for DTS encoded source materials such as LASER DISC, CD, and DVD and some 2channel signal source.

dts : This mode is enabled when playing source materials encoded in dts multi channel.

Playing multi-channel encoded 5.1-channel dts sources provides five main audio channels (left, center, right, surround left and surround right) and Low Frequency Effect channel.

dts-ES decoding is not available in this mode.

The DTS mode cannot use when an analog input has been selected.

Neo:6 Cinema, Neo6: Music

This mode decodes 2-channel signals into 6-channel signals using high-accuracy digital matrix technology.

The DTS NEO:6 decoder has near-discrete properties in the frequency characteristics of the channels as well as in channel separation.

According to the signals to be played back, DTS NEO:6 uses either the NEO:6 CINEMA mode optimized for movie playback or the NEO:6 MUSIC mode optimized for music playback.

Note:

- PCM-audio (32 kHz, 44.1 kHz or 48 kHz) and analog source material can playback in this mode.

MULTI CH. ST

This mode is used to create a wider, deeper and more natural soundstage from two channel source material.

This is done by feeding the left channel signal to both left front and left surround speaker and the right channel signal to both right front and right surround speaker. Additionally, the center channel reproduces a mix of the right and left channel.

CIRCLE SURROUND II (CSII-CINEMA, CSII-MUSIC, CSII-MONO)

Circle Surround is designed to enable multi-channel surround sound playback of non-encoded and multi-channel encoded material.

Backward compatibility provides listeners with up to 6.1 channels of surround performance from entire collection of music and film, including broadcast, videotape and stereo recorded music.

Regarding to source material, you can select **CSII-Cinema** mode, **CSII-Music** mode or **CSII-Mono** mode.

Note:

- PCM-audio (32 kHz, 44.1 kHz or 48 kHz) and analog source material can playback in this mode.

VIRTUAL

This mode creates a virtualized surround sound experience from a two-speaker (front L and R) playback system playing any multi-channel audio source (such as found on DVDs and digital broadcasts), including Dolby Digital, , Dolby Pro Logic or DTS.

SRS TruSurround, SRS and  symbol are trademarks of SRS Labs, Inc.

SRS TruSurround technology is incorporated under license from SRS Labs, Inc.

DSP SURROUND (MOVIE, HALL, STADIUM, MATRIX)

These modes provide surround effect processing from each input source material.

They will produce theater, concert hall and stadium like atmospheres. Select as your taste desires.

Note:

- PCM-audio (32 kHz, 44.1 kHz or 48 kHz) and analog source material can playback in this mode.

STEREO

This mode bypasses all surround processing.

Stereo program sources the left and right channels play normally when PCM-audio or analog stereo is input.

With Dolby Digital and DTS sources, the 5.1 multi-channels are converted to two channel stereo. 96 kHz PCM source material can be playback in stereo mode.

S (SOURCE) - DIRECT

In the source direct mode, the tone control circuit and bass management configuration are bypassed for full range frequency response and the purist audio reproduction.

96 kHz PCM source material can be play back in this mode.

Notes:

- Internal speaker size is setup to front L/R = Large, Center = Large, Surround L/R = Large and Subwoofer = yes automatically. Tone controls and additional processing are also defeated.
- When you use this mode with certain DVD and CD players, performing operations such as “Skip” or “Stop” may momentarily interrupt the output.

CAUTION***NOTE for DTS signal***

- * Connected DVD-player, laser-disc player or CD-player needs to support DTS-digital output. You may not be able to play some DTS source signals from certain CD players and LD players even if you connect the player to the SR6300 digitally. This is because the digital signal has been processed (such as the output level, sampling frequency, or frequency response) and the SR6300 cannot recognize the signal as DTS data.
- * Depending on the player used, DTS play may produce short noise. This is not a malfunction. In such cases, select the surround mode the “DTS” or “DTS-ES”.
- * If DTS cinema, DTS music or DTS-ES mode is selected, digital input cannot be switched to analog input.
- * When the analog input function has been selected, Surround mode cannot be switched to DTS cinema, DTS music or DTS-ES mode.
- * While signals from DTS-laser disc or CD are playing in another Surround mode, you cannot switch to digital input or from digital input to analog input by INPUT SETUP in SETUP MAIN MENU or A/D button.
- * The outputs for the VCR 1 OUT, DSS/VCR 2 OUT, TAPE OUT, and CD-R OUT output analog audio signals. Do not record from CDs or LDs that support DTS using these outputs. If you do, the DTS-encoded signal will be recorded as noise.

NOTE for Dolby Digital Surround EX signal

- * When playing Dolby Digital Surround EX-encoded software in 6.1 channels, it is required to set the EX/ES mode.
- * Note that some of Dolby Digital Surround EX-encoded software does not contain the identification signal. In this case, set the EX/ES mode manually.

NOTE for 96kHz PCM audio

- * AUTO, Source- DIRECT, and STEREO modes can be used when playing PCM signals with a sampling frequency of 96 kHz (such as from DVD-Video discs that contain 24 bit, 96 kHz audio). If such signals are input during playback in one of the other surround modes, output from SR6300 will be muted.
- * Certain DVD player models inhibit digital output. For details, refer to the player's operation manual.
- * Some DVD formatted discs featured copy protection. When using such disc, 96 kHz PCM signal is not output from the DVD player. For details, refer to the player's operation manual.

The relation between the selected surround mode and the input signal

The surround mode is selected with the surround mode selector knob of the SR6300 or the remote control unit. However, the sound from the speakers depend upon the relationship between the selected surround mode and the input signal. They are as follows;

SURROUND MODE	INPUT SIGNAL	OUTPUT CHANNELS					FLUORESCENT INDICATOR		
		L/R	C	SL/SR	SC	SW	FORMAT STATUS & SURROUND MODE	TEMPORARY DISPLAY STATUS	
AUTO	DOLBY DIGITAL(5.1CH)	○	○	○	-	○	AUTO, DOLBY, DIGITAL	AUTO	
	DOLBY DIGITAL(2CH)	○	-	-	-	○	AUTO, DOLBY, DIGITAL	AUTO	
	DOLBY DIGITAL (2CH:Lt/Rt)	○	○	○	-	○	AUTO, DOLBY, DIGITAL, PRO LOGIC II	AUTO	
	DOLBY DIGITAL EX(6.1CH)	○	○	○	○	○	AUTO, DOLBY, DIGITAL, SURROUND EX	AUTO	
	96KHZ PCM	○	-	-	-	-	AUTO, STEREO, PCM	AUTO -> 96KHz	
	PCM(AUDIO)	○	-	-	-	○	AUTO, STEREO	AUTO	
	ANALOG	○	-	-	-	○	AUTO, STEREO	AUTO	
	DTS(5.1CH)	○	○	○	-	○	AUTO, DTS	DTS-ES DISC -> AUTO	
	DTS-ES(6.1CH)	○	○	○	○	○	AUTO, DTS, ES	AUTO	
	PL II MOVIE	DOLBY DIGITAL(5.1CH)	○	○	○	-	○	DOLBY, DIGITAL	DOLBY D
		DOLBY DIGITAL(2CH)	○	○	○	-	○	DOLBY, DIGITAL, PRO LOGIC II	DOLBY PL II MV
		DOLBY DIGITAL(2CH:Lt/Rt)	○	○	○	-	○	DOLBY, DIGITAL, PRO LOGIC II	DOLBY PL II MV
DOLBY DIGITAL EX(6.1CH)		○	○	○	-	○	DOLBY, DIGITAL	DOLBY D	
96KHZ PCM		-	-	-	-	-			
PCM(AUDIO)		○	○	○	-	○	DOLBY, PRO LOGIC II, PCM	DOLBY PL II MV	
ANALOG		○	○	○	-	○	DOLBY, PRO LOGIC II	DOLBY PL II MV	
DTS(5.1CH)		-	-	-	-	-			
DTS-ES(6.1CH)		-	-	-	-	-			
PL II MUSIC		DOLBY DIGITAL(5.1CH)	○	○	○	-	○	DOLBY, DIGITAL	DOLBY D
		DOLBY DIGITAL(2CH)	○	○	○	-	○	DOLBY, DIGITAL, PRO LOGIC II	DOLBY PL II MS
		DOLBY DIGITAL(2CH:Lt/Rt)	○	○	○	-	○	DOLBY, DIGITAL, PRO LOGIC II	DOLBY PL II MS
	DOLBY DIGITAL EX(6.1CH)	○	○	○	-	○	DOLBY, DIGITAL	DOLBY D	
	96KHZ PCM	-	-	-	-	-			
	PCM(AUDIO)	○	○	○	-	○	DOLBY, PRO LOGIC II, PCM	DOLBY PL II MS	
	ANALOG	○	○	○	-	○	DOLBY, PRO LOGIC II	DOLBY PL II MS	
	DTS(5.1CH)	-	-	-	-	-			
	DTS-ES(6.1CH)	-	-	-	-	-			
	PRO LOGIC	DOLBY DIGITAL(5.1CH)	○	○	○	-	○	DOLBY, DIGITAL	DOLBY D
		DOLBY DIGITAL(2CH)	○	○	○	-	○	DOLBY, DIGITAL, PRO LOGIC	DOLBY PL
		DOLBY DIGITAL(2CH:Lt/Rt)	○	○	○	-	○	DOLBY, DIGITAL, PRO LOGIC	DOLBY PL
DOLBY DIGITAL EX(6.1CH)		○	○	○	-	○	DOLBY, DIGITAL	DOLBY D	
96KHZ PCM		-	-	-	-	-			
PCM(AUDIO)		○	○	○	-	○	DOLBY, PRO LOGIC, PCM	DOLBY PL	
ANALOG		○	○	○	-	○	DOLBY, PRO LOGIC	DOLBY PL	
DTS(5.1CH)		-	-	-	-	-			
DTS-ES(6.1CH)		-	-	-	-	-			
EX/ES		DOLBY DIGITAL(5.1CH)	○	○	○	○	○	DOLBY, DIGITAL, SURROUND EX	DOLBY D EX
		DOLBY DIGITAL(2CH)	-	-	-	-	-		
		DOLBY DIGITAL (2CH:Lt/Rt)	-	-	-	-	-		
	DOLBY DIGITAL EX(6.1CH)	○	○	○	○	○	DOLBY, DIGITAL, SURROUND EX	DOLBY D EX	
	96KHZ PCM	-	-	-	-	-			
	PCM(AUDIO)	-	-	-	-	-			
	ANALOG	-	-	-	-	-			
	DTS(5.1CH)	○	○	○	○	○	DTS, ES	DTS - ES MTRX	
	DTS-ES(6.1CH)	○	○	○	○	○	DTS, ES	DTS - ES DISC	
	DTS	DOLBY DIGITAL(5.1CH)	-	-	-	-	-		
		DOLBY DIGITAL(2CH)	-	-	-	-	-		
		DOLBY DIGITAL(2CH:Lt/Rt)	-	-	-	-	-		
DOLBY DIGITAL EX(6.1CH)		-	-	-	-	-			
96KHZ PCM		-	-	-	-	-			
PCM(AUDIO)		-	-	-	-	-			
ANALOG		-	-	-	-	-			
DTS(5.1CH)		○	○	○	-	○	DTS	DTS	
DTS-ES(6.1CH)		○	○	○	-	○	DTS	DTS	
Neo:6 CINEMA Neo:6 MUSIC		DOLBY DIGITAL(5.1CH)	-	-	-	-	-		
		DOLBY DIGITAL(2CH)	-	-	-	-	-		
		DOLBY DIGITAL(2CH:Lt/Rt)	-	-	-	-	-		
	DOLBY DIGITAL EX(6.1CH)	-	-	-	-	-			
	96KHZ PCM	-	-	-	-	-			
	PCM(AUDIO)	○	○	○	○	○	PCM	NEO: 6 CINEMA or MUSIC	
	ANALOG	○	○	○	○	○		NEO: 6 CINEMA or MUSIC	
	DTS(5.1CH)	-	-	-	-	-			
	DTS-ES(6.1CH)	-	-	-	-	-			
	MULTI CH. ST	DOLBY DIGITAL(5.1CH)	○	○	○	○	○	DOLBY, DIGITAL, SURROUND EX	M-CH STEREO
		DOLBY DIGITAL(2CH)	○	○	○	○	○	DOLBY, DIGITAL	M-CH STEREO
		DOLBY DIGITAL(2CH:Lt/Rt)	○	○	○	○	○	DOLBY, DIGITAL	M-CH STEREO
DOLBY DIGITAL EX(6.1CH)		○	○	○	○	○	DOLBY, DIGITAL, SURROUND EX	M-CH STEREO	
96KHZ PCM		-	-	-	-	-			
PCM(AUDIO)		○	○	○	○	○	PCM	M-CH STEREO	
ANALOG		○	○	○	○	○		M-CH STEREO	
DTS(5.1CH)		○	○	○	○	○	DTS, ES	M-CH STEREO	
DTS-ES(6.1CH)		○	○	○	○	○	DTS, ES	M-CH STEREO	

SURROUND MODE	INPUT SIGNAL	OUTPUT CHANNELS					FLUORESCENT INDICATOR	
		L/R	C	SL/SR	SC	SW	FORMAT STATUS & SURROUND MODE	TEMPORARY DISPLAY STATUS
CS2 CINEMA CS2 MUSIC CS2 MONO	DOLBY DIGITAL(5.1CH)	-	-	-	-	-		
	DOLBY DIGITAL(2CH)	-	-	-	-	-		
	DOLBY DIGITAL(2CH:Lt/Rt)	-	-	-	-	-		
	DOLBY DIGITAL EX(6.1CH)	-	-	-	-	-		
	96KHZ PCM	-	-	-	-	-		
	PCM(AUDIO)	○	○	○	○	○	PCM	CS-2 CINEMA or MUSIC or MONO
	ANALOG	○	○	○	○	○		CS-2 CINEMA or MUSIC or MONO
	DTS(5.1CH)	-	-	-	-	-		
VIRTUAL	DOLBY DIGITAL(5.1CH)	○	-	-	-	○	VIRTUAL, DOLBY, DIGITAL	VIRTUAL
	DOLBY DIGITAL(2CH)	○	-	-	-	○	VIRTUAL, DOLBY, DIGITAL, PRO LOGIC	VIRTUAL
	DOLBY DIGITAL(2CH:Lt/Rt)	○	-	-	-	○	VIRTUAL, DOLBY, DIGITAL, PRO LOGIC	VIRTUAL
	DOLBY DIGITAL EX(6.1CH)	○	-	-	-	○	VIRTUAL, DOLBY, DIGITAL	VIRTUAL
	96KHZ PCM	-	-	-	-	-		
	PCM(AUDIO)	○	-	-	-	○	VIRTUAL, PRO LOGIC, PCM	VIRTUAL
	ANALOG	○	-	-	-	○	VIRTUAL, PRO LOGIC	VIRTUAL
	DTS(5.1CH)	○	-	-	-	○	VIRTUAL, DTS	VIRTUAL
(DSP SURROUND) MOVIE HALL STADIUM MATRIX	DTS-ES(6.1CH)	○	-	-	-	○	VIRTUAL, DTS	VIRTUAL
	DOLBY DIGITAL(5.1CH)	-	-	-	-	-		
	DOLBY DIGITAL(2CH)	-	-	-	-	-		
	DOLBY DIGITAL(2CH:Lt/Rt)	-	-	-	-	-		
	DOLBY DIGITAL EX(6.1CH)	-	-	-	-	-		
	96KHZ PCM	-	-	-	-	-		
	PCM(AUDIO)	○	○	○	-	○	DSP SOUND, PCM	MOVIE or HALL or STADIUM or MATRIX
	ANALOG	○	○	○	-	○	DSP SOUND	MOVIE or HALL or STADIUM or MATRIX
STEREO	DTS(5.1CH)	-	-	-	-	-		
	DTS-ES(6.1CH)	-	-	-	-	-		
	DOLBY DIGITAL(5.1CH)	○	-	-	-	○	STEREO, DOLBY, DIGITAL	STEREO
	DOLBY DIGITAL(2CH)	○	-	-	-	○	STEREO, DOLBY, DIGITAL	STEREO
	DOLBY DIGITAL(2CH:Lt/Rt)	○	-	-	-	○	STEREO, DOLBY, DIGITAL	STEREO
	DOLBY DIGITAL EX(6.1CH)	○	-	-	-	○	STEREO, DOLBY, DIGITAL	STEREO
	96KHZ PCM	○	-	-	-	-	STEREO, PCM	STEREO -> 96KHz
	PCM(AUDIO)	○	-	-	-	○	STEREO, PCM	STEREO
S-DIRECT	ANALOG	○	-	-	-	○	STEREO	STEREO
	DTS(5.1CH)	○	-	-	-	○	STEREO, DTS	STEREO
	DTS-ES(6.1CH)	○	-	-	-	○	STEREO, DTS	STEREO
	DOLBY DIGITAL(5.1CH)	○	○	○	-	○	DIRECT, DOLBY, DIGITAL	S-DIRECT
	DOLBY DIGITAL(2CH)	○	-	-	-	○	DIRECT, DOLBY, DIGITAL	S-DIRECT
	DOLBY DIGITAL(2CH:Lt/Rt)	○	○	○	-	○	DIRECT, DOLBY, DIGITAL	S-DIRECT
	DOLBY DIGITAL EX(6.1CH)	○	○	○	-	○	DIRECT, DOLBY, DIGITAL, SURROUND EX	S-DIRECT
	96KHZ PCM	○	-	-	-	-	DIRECT, STEREO, PCM	S-DIRECT -> 96KHz
PCM(AUDIO)	○	-	-	-	○	DIRECT, STEREO, PCM	S-DIRECT	
	ANALOG	○	-	-	-	○	DIRECT, STEREO	S-DIRECT
	DTS(5.1CH)	○	○	○	-	○	DIRECT, DTS	S-DIRECT
	DTS-ES(6.1CH)	○	○	○	-	○	DIRECT, DTS, ES	S-DIRECT

Note:

- Dolby Digital (2 ch: Lt/Rt): signal with Dolby Surround flag Speakers are full set.
- No sound outputs from the surround speaker, center speaker and subwoofer if the DVD disc has no surround data.

L/R : Front speakers
 C : Center speaker
 SL/SR : Surround speakers
 SC : Surround Center speaker
 SW : Sub woofer speaker

TROUBLE SHOOTING

If the unit does not operate properly, check items shown in the following table.

If your trouble cannot be recovered with the remedy actions listed in the following table, malfunction of the internal circuitry is suspected; immediately unplug the power cable and contact your dealer, nearest Marantz distributor or the Marantz Service Center in your country.

In case of trouble, check the following before calling for service:

1. Are the connections made properly ?
2. Are you operating the unit properly following user's guide ?
3. Are the power amplifiers and speaker working properly ?

SYMPTOM	CAUSE	REMEDY
SR6300 cannot be turned up.	The power plug is not connected.	Connect the power plug to the outlet.
No sound and picture are output even when power is on.	Mute is on. The input cable is not connected correctly. The master volume control is turned all the way down. The function selector position is wrong.	Cancel mute using the remote control unit. See the connection diagram and connect the cables correctly. Adjust the master volume. Select correct position.
Speaker does not outputting any sound.	The headphones are connected to the headphone jack.	Disconnect the headphones. (Speakers will not output sound when headphones are connected.)
Sound and pictures from other than equipment selected with the function selector.	Input cable connected incorrectly.	Connect the cable correctly by referring to the connection diagram.
Sound from the wrong channel is output from the speaker.	Speaker cable connected incorrectly.	Connect the cable correctly by referring to the connection diagram.
No sound is output from the center speaker.	The center speaker cable connection is incomplete. STEREO has been selected for Surround mode. Center = NONE has been selected in SETUP mode.	Connect the cable correctly. When STEREO is selected for Surround mode, no sound will be output from the center speaker. Set another Surround mode. Make the correct setting.
No sound is output from the surround speakers.	The surround speaker cable connection is incomplete. STEREO has been selected for Surround mode. Surround = NONE has been selected in SETUP mode.	Connect the cable correctly. When STEREO has been selected for Surround mode, no sound will be output from the surround speaker. Set another Surround mode. Make the correct setting.
No sound is output from the surround center	The surround center speaker cable connection is incomplete Surround mode is not EX/ES mode. Surround center= NONE has been selected in SPEAKERS SIZE SETUP	Connect the cable correctly. Set surround mode EX/ES Make the correct setting.
Can not select EX/ES mode.	Surround center= NONE has been selected in SPEAKERS SIZE SETUP Input signal is incompatible.	Make the correct setting. Use 5.1channel source.
Can not select Pro Logic II mode.	Input signal is incompatible.	Use 2 channel Dolby Digital input signal, PCM input signal or analog input signal.
Can not select Neo 6 mode.	Input signal is incompatible.	Use PCM input signal or analog input signal.
Can not select CSII mode.	Input signal is incompatible.	Use PCM input signal or analog input signal.
No output to Sub Woofer Out.	Sub-woofer = NONE has been selected in SETUP mode.	Select Sub-woofer = YES.
Noise is produced during DTS-encoded CD or laser disc play.	Analog has been selected for input.	Be sure to perform digital connection, select digital input, then play.
A specific channel does not produce output.	Nothing recorded on source.	Check the encoded channel on the source side.
FM or AM reception fails.	Antenna connection is incomplete.	Correctly connect the indoor FM and AM antennas to FM and AM antenna outlets.
Noise is heard during AM reception.	Reception is affected by other electrical fields.	Try changing location where the AM indoor antenna is set up.
Noise is heard during FM reception.	The radio waves from the broadcasting station are weak.	Install an FM outdoor antenna.
Cannot get programmed station when the PRESET button is pressed.	Preset data has been erased.	Disconnecting power plug for long periods of time will erase preset data. If that happens, input the preset data again.
Control with the remote control unit fails.	Batteries are consumed. Remote controller's function-key setting is wrong. The distance between this SR6300 and the remote commander is too far. Something is blocking SR6300 and the remote commander.	Replace all the batteries with new ones. Select different position from which equipment will be controlled. Move closer to this SR6300. Remove offending object.

GENERAL MALFUNCTION

If the equipment malfunctions, this may be because an electrostatic discharge or AC line interference has corrupted the information in the equipment memory circuits. Therefore:

- disconnect the plug from the AC line supply
- after waiting at least three minutes, reconnect the plug to the AC line supply
- re-attempt to operate the equipment

Memory backup

- In case a power outage occurs or the power cord is accidentally unplugged, the SR6300 is equipped with a backup function to prevent memory data such as the preset memory from being erased.

The memory functions are backed up for up to about one week.

Note:

- First of all keep SR6300 Standby or Powered-on more than 6 hours, to sufficient time for memory back up.

HOW TO RESET THE UNIT

Should the operation or display seem to be abnormal, reset the unit with the following procedure.

1. The SR6300 is turned on, press and hold the **A/D** ⑦ and **DIMMER** ⑩ buttons simultaneously for 3 seconds or more.

Note:

- Remember that the procedure will reset the settings of the function selector, Surround mode, delay time, TUNER PRESET etc., to their initial settings.

TECHNICAL SPECIFICATIONS

FM TUNER SECTION

Frequency Range 87.5 - 108.0 MHz
 Usable Sensitivity IHF 1.8 μ V/16.4 dB
 Signal to Noise Ratio Mono/Stereo 75/70 dB
 Distortion Mono/Stereo 0.2/0.3 %
 Stereo Separation 1 kHz 45 dB
 Alternate Channel Selectivity \pm 300 kHz 60 dB
 Image Rejection 98 MHz 70 dB
 Tuner Output Level 1 kHz, \pm 40 kHz Dev 500 mV

AM TUNER SECTION

Frequency Range AM: 522 - 1611 kHz
 Signal to Noise Ratio 50 dB
 Usable Sensitivity Loop 400 μ V/m
 Distortion 400 Hz, 30 % Mod. 0.5 %
 Selectivity \pm 18 kHz 60 dB

AUDIO SECTION

Power Output (20 Hz - 20 kHz/THD=0.08%)
 Front L&R 8 ohms 100 W / Ch
 Center 8 ohms 100 W / Ch
 Surround L&R 8 ohms 100 W / Ch
 Surround Center 8 ohms 100 W / Ch

Front L&R 6 ohms 125 W / Ch
 Center 6 ohms 125 W / Ch
 Surround L&R 6 ohms 125 W / Ch
 Surround Center 6 ohms 125 W / Ch

Input Sensitivity/Impedance
 Linear 340 mV/ 47 Kohms

Signal to Noise Ratio
 Linear 105 dB

VIDEO SECTION

Television Format NTSC/PAL
 Input Level/Impedance 1 Vp-p/ 75 ohms
 Output Level/Impedance 1 Vp-p/ 75 ohms
 Video Frequency Response 5 Hz to 8 MHz (- 1 dB)
 S/N 60 dB

GENERAL

Power Requirement AC 230 V 50 Hz
 Power Consumption 380 W
 Weight 14.8 Kg

ACCESSORIES

Remote Controller RC7300SR 1
 AA-size batteries 2
 FM Feeder Antenna 1
 FM Antenna Converter 1
 AM Loop Antenna 1
 AC Power Cord 1
 Registration Card 1
 User Guide 1

Specifications subject to change without prior notice.

DIMENSION

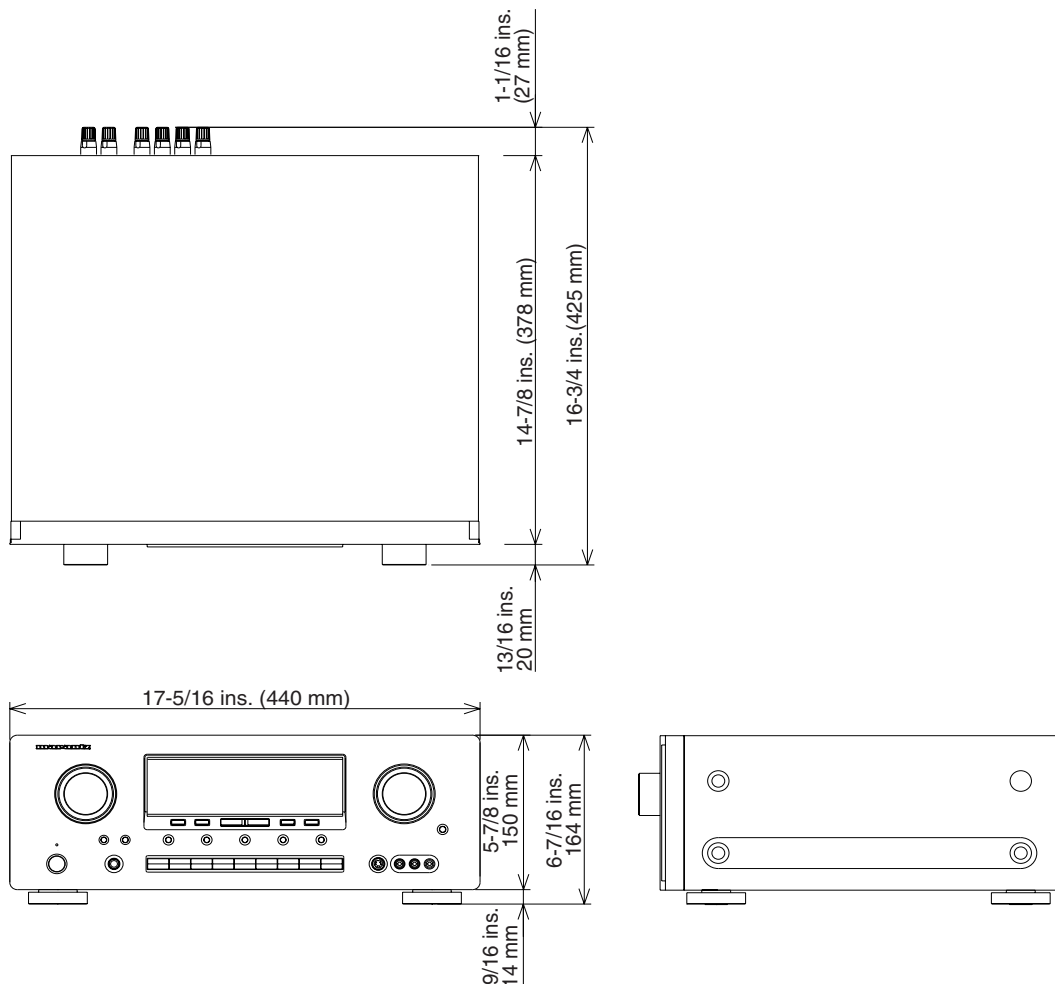

COUNTRY	COMPANY	ADDRESS
ALGERIE	Azur 2000	8, Lotissement Ben Hatadi, Alger, Algerie
ARMENIA	NGYIG Ltd.	47 A/75 St. Lalaants, 375000 Yerevan, Armenia
AUSTRALIA	QualiFi Pty. Ltd.,	P.O. Box 350, Mt. Waverley, VIC 3149, Australia
AUSTRIA	Huber & Prohaska GmbH	Taborstraße 95 / Ladestraße 1, Gebäude Hangartner, A-1200 Wien, Austria
BAHREIN	Ambassador Stores	P.O. Box 237,141, Government Avenue, Manama,Bahrein
BANGLADESH	Target	1078, Ramjoy Mohanja Lane Asadgonj, Chittagong 4000, Bangladesh
BELGIUM	Van der Heyden Audio N.V.	Brusselbaan 278, 9320 Erembodegem, Belgium
BULGARIA	Ariescommerce GmbH	Makedonia Blvd. 16, 1606 Sofia, Bulgaria
CANADA	Lenbrook Industries Limited	633 Granite Court, Pickering, Ontario
CHINA	Guang Chang Audio International Co., Ltd.	No.38 Yushan Road, ShiQiao, Pan Yu, Guang Dong, China
CYPRUS	Empire Hifi systems Ltd.	P.O. Box 5604, Nicosia, Cyprus
CZECH REPUBLIC	Audio International	Sokolska 41, 67902 Rajecsko, OKR,Blansko, Czech Republic
DENMARK	Audio Nord	Dali Allé 1, 9610 Noerager, Denmark
DUBAI	V.V.& SONS	P.O. Box 105, Dubai, U.A.E.
EGYPT	Solimco	9, El Attibaa St. Doki, Cairo, Egypt
ESTONIA	HiFi Club Estonia	Ehte 4, 90503 Haapsalu, Estonia
F.Y.R.O.M.	T.P. KODI	ul.Cedomir Kantargiev 21a, Skopje, Former Yugoslavian Republic of Macedonia
FINLAND	Audio Nord	Uudenmaankatu 4-6, Helsinki SF-00120, Finland
FRANCE	Marantz France	A division of Marantz Europe B.V., P.O. Box 301, 92 156 Suresnes Cedex, France
GERMANY	Marantz Deutschland	Hakenbusch 3, 49078 Osnabrück, Germany
GREECE	Adamco S.A.	188, Hippocratous Street, 11471 Athens, Greece
HEADQUARTERS EUROPE:	Marantz Europe B.V.	P.O. Box 8744, 5605 LS Eindhoven, The Netherlands
HONG KONG	Marantz Hong Kong Ltd.	Unit 1706, Metroplaza II, 223 Hing Fong Road, Kwai Fong, N.T., Kowloon, Hong Kong
HUNGARY	Infobox Ltd.	Terez Krt.31, 1067 Budapest, Hungary
ICELAND	ID Electronics Ltd.	Armula 38, 108 Reykjavik, Iceland
INDIA	NOVA Audio Private	8,Punam Co-op.Society 29/30 Road#5, Union Park MUMBAI 400052, India
IRAN	Home Co.	5th floor no 878 Philips Building Enghelab ave, P.O. 11365/7844 Tehran, Iran
IRELAND	Marantz Ireland	Clonskeagh, Dublin 14, Ireland
ISRAEL	Elmor Ltd.	52 Heh Beiyar Street, Kikar Hamedina, Tel Aviv, Israel
ITALY	Marantz Italy	Via Casati 23, 20052 Monza (Milano), Italy, Servizio Consumatori 1678-20026, Numero Verde
IVORY COAST	Hifivoir	B.P. 2428, Abidjan 01, Ivory Coast
JAPAN	Marantz Japan Inc.	35-1 Sagami Ohno 7-Chome, Sagamihara-shi, Kanagawa 228-8505, Japan
KOREA	MK Enterprises Ltd.	Rm604, Electro-officetel, 16-58. Hangang-ro 3Ga, Yongsan-Ku, Seoul, Korea
KUWAIT	alAlamiah Electronics Intl.	P.O. Box 8196, Salmiah 22052, Kuwait
LATVIA	Ace Ltd.	61, LacPlesa Str., Riga LV 1011, Latvia
LEBANON	AZ Electronics S.A., 1,	P.O. Box 11 2833, Beirut, Lebanon
LITHUANIA	Accapella Ltd.	Ausros, Vartu G/5, Pasazo SKG., 2001 Vilnius, Lithuania
MALAYSIA	Wo Kee Hong Electronics Sdn. Bhd.	2nd Floor Bangnan Infinite Centre, Lot1, Jalan 13/6, 46200 Petaling Jaya, Selangor Datul Ehsan, Malaysia
MALTA	Doneo Co Ltd.	78 The Strand, Sliema SLM07, Malta
MAURITIUS	SKR Electronics Ltd.	P.O. Box 685, Bell Village, Port Louis, Mauritius
MILITARY MARKET EUROPE	PASCO GmbH	PO BOX 1280, Sandhausen 69200, Germany
NEW ZEALAND	Wildash Audio Systems	14 Malvern Road, Mt. Albert, Auckland, New Zealand
NORWAY	Audio Nord	Sandkerveien 64, Oslo 0483, Norway
OMAN	Mustafa & Jawad Trading CO.	P.O. Box 1918, Ruwi, Oman
POLAND	Philips Polska Sp. z.o.o.	Al.Jerozolimskie 195b, 02 222 Warszawa, Poland
PORTUGAL	Corel2	Comércio de Electrónica Lda., Av. Luis Bivar, No 85 A, 1050 Lisboa, Portugal
PROFESSIONAL EUROPE	Marantz U.K. Ltd.	Kingsbridge House, Padbury Oaks, 575-583 Bath Road, Longford, Middlesex UB7 0EH, U.K.
PROFESSIONAL U.S.A.	Marantz America Inc.	1100 Maplewood Drive Itasca, IL 60143, U.S.A.
QATAR	Almana & Partners W.W.L.	P.O. Box 49, Doha, Qatar
REUNION	Vision +	180 Rue du Marechal Leclerc, 97400 Saint Denis, Ile de la Reunion
ROMANIA	Nova Music Entertainment	5, Zagazului Str. Bl.1G,apt.18, sector 1,Bucharest, Romania
RUSSIA	Absolute Audio	7/2, Montazhnaya Street, 107497 Moscow, Russia
SAUDI ARABIA	Adawlia Univ. Electr. Apl	P.O. Box 2154, Alkhobar 31952, Saudi Arabia
SINGAPORE	Wo Kee Hong Distribution PTE Ltd.	130 Joo Seng Road, #03-02 Olivine Building, Singapore 368357
SLOVAKIA	Bis Audio s.r.o.	Nam. SNP 10, 96001 Zvolem, Slovakia
SLOVENIA	Bofex	Smartinska 152, HALA V/3, 61000 Ljubljana, Slovenia
SOUTH AFRICA	Coherent Imports (PTY) Ltd.	P.O. Box 1614, Alberton, 1450, South Africa
SPAIN	Marantz Spain	Martinez Villergas 2, Apartado 2065, Madrid 28027, Spain
SRI LANKA	The listening Room	Mezzanine Floor, The Landmark 385, Galle Road, Colombo - 3, Sri Lanka
SWEDEN	Audio Nord	Almedalsvagen 4, Gotenborg 402-23, Sweden
SWITZERLAND	Sound Company AG	Postfach, 8010 Zürich, Switzerland
SYRIA	Hamzeh & Partners	Hafez Ibrahim Str. No 117, Damascus Shalan, Syria
TAHITI	Covecolor	Av. Prince Hinoi, Cours de l'union sacré, P.O. Box 2334, Papeete, Tahiti
TAIWAN	Pai-Yuing Co. Ltd.	6th No 148 Sung Kiang Road, Taipei 10429, Taiwan R.O.C.
THAILAND	MRZ Standard Co. Ltd.	746-750 Mahachai Road, Wangburapa, Bangkok 10200, Thailand
TUNESIA	Societe EDEVIG	40, Avenue du Golfe Arabe, El Menzah, 1004, Tunesia
TURKEY	Türk Philips Ticaret A.S.	Yukari Dudullu Organize sanayi Bolgesi, 2.Cadde no.28, 81260 Umraniye-Istanbul, Turkey
U.K.	Marantz U.K. Ltd.	Kingsbridge House, Padbury Oaks, 575-583 Bath Road, Longford, Middlesex UB7 0EH, U.K.
U.S.A.	Marantz America Inc.	1100 Maplewood Drive Itasca, IL 60143, U.S.A.
YUGOSLAVIA	ITM Company	Omladinskih Brigada 86, 11070 Belgrade, Yugoslavia

www.marantz.com

Manufactured under license from Dolby Laboratories. "Dolby", "Pro Logic", and the double-D symbol are trademarks of Dolby Laboratories. "DTS", "DTS-ES Extended Surround" and "Neo:6" are trademarks of Digital Theater Systems, Inc.

marantz® is a registered trademark.

